

**APPENDIX A
ENGINEERING APPENDIX**

TABLE OF CONTENTS

A.	ENGINEERING DESIGN APPENDIX.....	A-1
A.1	Recommended Plan	A.1-1
A.1.1	Proposed Storage Reservoir	A.1-4
A.1.2	Proposed Improvements at S-84 Site.....	A.1-5
A.1.3	Potential Relocation of S-83 for Consideration/Evaluation During the PED Phase	A.1-6
A.1.4	Potential Elimination of SPS-1 for Consideration/Evaluation During the PED Phase ...	A.1-7
A.2	Status of Engineering Design Activities and Analyses	A.2-1
A.2.1	Level of Design Efforts	A.2-1
A.2.2	Recommendation for Design Completion	A.2-2
A.3	General Construction Procedures Discussion	A.3-1
A.3.1	General Construction Recommendations	A.3-1
A.3.2	Construction Contracts and Schedule	A.3-1
A.3.3	Construction Sequencing and Staging.....	A.3-2
A.3.4	Demolition and Disposal.....	A.3-5
A.3.5	Other Projects Affecting Construction	A.3-6
A.4	General Design Requirements and Criteria	A.4-1
A.4.1	Project Limits and Site Datum	A.4-1
A.4.2	Survey and Geographic Information System (GIS) Data.....	A.4-1
A.4.3	Service Life.....	A.4-1
A.4.4	Units	A.4-2
A.4.5	Codes and Standards	A.4-2
A.5	Hydrology.....	A.5-1
A.5.1	Hazard Classification and Emergency Evacuation Requirements	A.5-1
A.5.2	Design Storms and Floods	A.5-1
A.5.3	Reservoir Inflows and Outflows	A.5-3
A.5.4	Wave and Overtopping Analysis–Traditional Method	A.5-6
A.5.5	Wave and Overtopping Analysis – Alternate Approach	A.5-12
A.5.6	Reservoir Seiche Analysis	A.5-13
A.5.7	References.....	A.5-14
A.6	Hydraulic Design	A.6-1
A.6.1	Introduction.....	A.6-1
A.6.2	General Reservoir Design Guidelines	A.6-1
A.6.3	Gravity Conveyance Structures	A.6-2
A.6.4	Pump Stations.....	A.6-5
A.6.5	Canals	A.6-7
A.6.6	References.....	A.6-8
A.7	Geotechnical Considerations for Construction	A.7-1
A.7.1	Geotechnical Data Review.....	A.7-1
A.7.2	LOCAR Geotechnical Investigation	A.7-2
A.7.3	Stratigraphy	A.7-4
A.7.4	Piezometers.....	A.7-4
A.7.5	Laboratory Test Results.....	A.7-5
A.7.6	Seismicity	A.7-6
A.7.7	Borrow	A.7-6
A.7.8	Excavations	A.7-6

A.7.9	Design Parameters	A.7-7
A.8	Geotechnical Embankment/Dam Design.....	A.8-1
A.8.1	General	A.8-1
A.8.2	Dam Safety Features	A.8-1
A.8.3	Conceptual Dam Embankment.....	A.8-2
A.8.4	Design Criteria	A.8-6
A.8.5	Embankment/Dam Materials	A.8-7
A.8.6	Material Properties	A.8-7
A.8.7	Seepage Control	A.8-8
A.8.8	Stability	A.8-11
A.8.9	Perimeter Canal Stability	A.8-12
A.8.10	Sensitivity Analyses	A.8-13
A.8.11	Erosion Protection	A.8-15
A.8.12	Foundations.....	A.8-15
A.8.13	Settlement.....	A.8-16
A.8.14	Borrow	A.8-16
A.8.15	Embankment Sections Evaluation	A.8-17
A.8.16	Closing and Recommendations	A.8-17
A.9	Reservoir Seepage	A.9-1
A.9.1	Introduction.....	A.9-1
A.9.2	3D Groundwater Model Development.....	A.9-1
A.9.3	Simulated Seepage Impact	A.9-19
A.9.4	Model Limitations and Recommendations	A.9-10
A.9.5	References.....	A.9-12
A.10	Structural Design Criteria	A.10-1
A.10.1	Applicable Codes and Standards	A.10-1
A.10.2	Design Stresses	A.10-1
A.10.3	Loading Criteria	A.10-1
A.10.4	Hydraulic Structures and Pumping Station Substructure	A.10-3
A.10.5	Building Structures	A.10-4
A.10.6	Inspection Requirements	A.10-5
A.10.7	Bridges.....	A.10-5
A.11	Site Civil Design	A.11-1
A.11.1	Project Layout.....	A.11-1
A.11.2	Impacts to C-41A Levees and Required Section 408 Approval	A.11-1
A.11.3	Site Access, Roadways, and Bridges	A.11-2
A.11.4	Stormwater Control/Site Drainage.....	A.11-2
A.11.5	Utilities	A.11-2
A.12	Mechanical Design.....	A.12-1
A.12.1	Introduction.....	A.12-1
A.12.2	Pump Station	A.12-1
A.12.3	Gated Structures	A.12-30
A.13	Electrical Design.....	A.13-1
A.13.1	Design Criteria	A.13-1
A.13.2	Pump Station Engineering Guidelines	A.13-9
A.13.3	Gate/Adjustable Weir Operators and Controls	A.13-10
A.14	Instrumentation and Controls	A.14-1
A.14.1	Design Criteria	A.14-1

A.14.2	LOCAR and Canals.....	A.14-1
A.14.3	Water Control Facilities	A.14-1
A.14.4	LOCAR Pump Stations.....	A.14-1
A.14.5	Telemetry	A.14-4
A.15	Architectural.....	A.15-1
A.15.1	Design Criteria for Pump Station Buildings	A.15-1
A.15.2	Exterior Architectural Features for Pump Station Buildings	A.15-2
A.15.3	Interior Architectural Features for Pump Station Buildings	A.15-3
A.16	HVAC, Plumbing, and Fire Suppression Systems.....	A.16-1
A.16.1	Design Criteria for Pump Station Buildings	A.16-1
A.16.2	HVAC for Pump Station Buildings.....	A.16-1
A.16.3	Potable Water for Pump Station Buildings.....	A.16-3
A.16.4	Freshwater Supply System for Pump Station Buildings	A.16-3
A.16.5	Sanitary System for Pump Station Buildings	A.16-3
A.16.6	Stormwater System for Pump Station Buildings	A.16-4
A.16.7	Fire Suppression System for Pump Station Buildings.....	A.16-4
A.17	Access and Security.....	A.17-1
A.17.1	Access	A.17-1
A.17.2	Security.....	A.17-1
A.18	Operations and Maintenance	A.18-1
A.19	Dam Safety Considerations and Emergency Action Plan	A.19-1
A.19.1	Dam Safety Considerations	A.19-1
A.19.2	Emergency Action Plan.....	A.19-8

ANNEXES

A-1 – Hydraulic Design

- A-1.1 Hydraulic Modeling and Calculations
- A-1.2 Horsepower Calculations for Pump Stations

A-2 – Hydrologic Modeling

- A-2.1 PMP Determination and PMF Routing Technical Memorandum
- A-2.2 STWAVE Overtopping Analysis Technical Memorandum
- A-2.3 Computational Fluid Dynamics Overtopping Analysis Technical Memorandum
- A-2.4 SFWMD Regional Simulation Model Documentation Report
- A-2.5 Assessment of Allowable Wave Overtopping Technical Memorandum
- A-2.6 Reservoir Perimeter Canal System Modeling Technical Memorandum
- A-2.7 Dam Breach Modeling Technical Memorandum

B-1 – LOCAR Subsurface Soil Exploration Report

B-2 – LOCAR Geotechnical Analysis Figures

C-1 – Civil Plates

- Existing Condition Drainage Map
- Proposed Condition Drainage Map
- Overall Site Plan for Recommended Plan
- Overall Site Plan for Recommended Plan with FEMA FIRM Floodplains
- Section Location Plan for Recommended Plan

- Reservoir West Inflow-Outflow Canal (CNL-3) Site Plan for Recommended Plan
- Earthwork Typical Sections for Recommended Plan
- PS-1 Pump Station and S-84+ Spillway Site Plan for Recommended Plan
- PS-1 Pump Station Section for Recommended Plan
- S-84+ Spillway Section for Recommended Plan
- PS-2 Pump Station and Adjacent Structures Site Plan for Recommended Plan
- Sections for Reservoir Dam Structures for Recommended Plan

C-2 – Documentation for Florida Gas Transmission Company Permanent Easement

C-3 – Documentation for Highlands County 2018 LiDAR DEM Dataset

D-1 – Mechanical Plates (PLACEHOLDER - NOT USED)

E-1 – Conceptual Electrical Utility Plan for Recommended Plan

F-1 – Register of Project-Specific Engineering Tasks to be Completed During the PED Phase

LIST OF TABLES

Table A.1-1.	Summary of Recommended Plan Project Features.....	A.1-8
Table A.4-1.	Summary of CERP Design Criteria Memoranda.....	A.4-9
Table A.5-1.	Wind and Precipitation Design Conditions.....	A.5-3
Table A.5-2.	10-year and 100-year Design Storm Routing Results.....	A.5-4
Table A.5-3.	Summary of Calculated Wind Setup–East Cell.....	A.5-8
Table A.5-4.	Summary of Calculated Wind Setup–West Cell.....	A.5-8
Table A.5-5.	LOCAR Wave Prediction Results.....	A.5-9
Table A.5-6.	Design Conditions Adopted for the Overtopping Analysis–East Cell.....	A.5-9
Table A.5-7.	Design Conditions Adopted for the Overtopping Analysis–West Cell.....	A.5-10
Table A.5-8.	Calculated mean overtopping discharge.....	A.5-10
Table A.5-9.	Summary of Overtopping Probability and Maximum Overtopping Volume for a Single Wave (Assuming 3-hour Storm Duration).....	A.5-11
Table A.7-1.	Background Borings near Project Area.....	A.7-2
Table A.7-2.	Geotechnical Investigation at Project Area.....	A.7-4
Table A.7-3.	Generalized Subsurface Soil Profile.....	A.7-4
Table A.8-1.	Seepage and Stability Analysis Parameters.....	A.8-8
Table A.8-2.	Exit Gradients and Factors of Safety against Soil Heave/Piping.....	A.8-10
Table A.8-3.	Computed Seepage from the Reservoir.....	A.8-11
Table A.8-4.	Results of Stability Analysis.....	A.8-12
Table A.8-5.	Sensitivity Analysis for Variation of Embankment Crest and Pool Elevation.....	A.8-13
Table A.8-6.	Sensitivity Analyses for Canal Surface, Wall Depth, and Materials, Cross-Section A...	A.8-14
Table A.9-1.	Interpreted Hydrogeologic Units from Boring Materials.....	A.9-4
Table A.9-2.	Comparison of 2D and 3D models with similar parameters.....	A.9-9
Table A.9-3.	3D Groundwater Model Layers and Hydrogeological Units.....	A.9-10
Table A.9-4.	Calculated Seasonal Average Rainfall and Reference Evapotranspiration based on DBHYDRO data at S-83_R.....	A.9-11
Table A.9-5.	Recharge/ET Zones and Crop Coefficients (Kc).....	A.9-11
Table A.9-6.	Simulation of Project Features.....	A.9-17

Table A.9-7.	Perimeter Canal Reaches and Average Geometries.....	A.9-18
Table A.9-8.	Perimeter Canal Reaches 1 through 7 Control Elevations for the Wet & Dry Season.....	A.9-1
Table A.9-9.	Wet Season Simulated Outflow from Reservoir and from Perimeter Canal.....	A.9-4
Table A.9-10.	Dry Season Simulated Outflow from Reservoir and from Perimeter Canal.....	A.9-4
Table A.9-11.	Wet Season Excess Flow Extracted by the Farm Canals (Drain Boundaries).....	A.9-6
Table A.9-12.	Dry Season Excess Flow Extracted by the Farm Canals (Drain Boundaries).....	A.9-7
Table A.9-13.	Wet Season Simulated Seepage Outflow from the Reservoir and Removed by Perimeter Canal with Varying Aquifer Conductivities.....	A.9-8
Table A.9-14.	Wet Season Simulated Seepage Outflow from the Reservoir and Removed by the Perimeter Canal with Varying Perimeter Canal Conductance.....	A.9-10
Table A.11-1.	Reservoir Stage Storage.....	A.11-1
Table A.11-2.	SFWMMD ROW Permits for Utilities within the C-41A ROW Adjacent to the Project's Limits of Construction.....	A.11-3
Table A.12-1.	Pump Station Canal and Reservoir Conditions.....	A.12-17
Table A.12-2.	PS-1 Pump Station Static Head.....	A.12-17
Table A.12-3.	PS-2 Pump Station Static Head.....	A.12-17
Table A.12-4.	SPS-1 Pump Station Static Head.....	A.12-18
Table A.12-5.	Fitting Friction Factors (K).....	A.12-18
Table A.12-6.	PS-1 Friction Losses at Maximum Capacity.....	A.12-18
Table A.12-7.	PS-2 Friction Losses at Maximum Capacity.....	A.12-19
Table A.12-8.	SPS-1 Friction Losses at Maximum Capacity.....	A.12-19
Table A.12-9.	Pump Design Capacity at Rated Conditions (Running).....	A.12-19
Table A.12-10.	Pump Design Capacity at Rated Conditions (Starting).....	A.12-19
Table A.12-11.	Pump Material Specifications.....	A.12-25
Table A.12-12.	Pipe Wall Thickness.....	A.12-29
Table A.15-1.	Exceptions to the Building Service Lifespan.....	A.15-2
Table A.16-1.	Project Site Design Criteria.....	A.16-1
Table A.16-2.	Indoor Design Criteria for PS-1 Building and PS-2 Building.....	A.16-2

LIST OF FIGURES

Figure A.1-1.	Vicinity Map for Recommended Plan.	A.1-1
Figure A.1-2.	Recommended Plan major Project features map.	A.1-2
Figure A.1-3.	Existing ground surface topography at the LOCAR site.	A.1-3
Figure A.1-4.	Overall site plan of Recommended Plan.	A.1-13
Figure A.5-1.	Typical cross-section for the LOCAR embankment.	A.5-7
Figure A.7-1.	Existing boring locations (background borings) and J-Tech’s 2023 investigation.	A.7-3
Figure A.7-2.	Piezometer Groundwater Readings and Rainfall Data.	A.7-5
Figure A.8-1.	Typical Sections A, B, C and D Location Map.	A.8-4
Figure A.8-2.	Typical Section A – Perimeter Dam and Perimeter Canal.	A.8-5
Figure A.8-3.	Typical Section A – Perimeter Dam and Perimeter Canal.	A.8-13
Figure A.9-1.	3D groundwater model area.	A.9-2
Figure A.9-2.	Project area and adjacent lands.	A.9-3
Figure A.9-3.	Unit A bottom elevation.	A.9-5
Figure A.9-4.	Unit B bottom elevation.	A.9-5
Figure A.9-5.	Unit C bottom elevation.	A.9-6
Figure A.9-6.	Unit B horizontal hydraulic conductivities.	A.9-6
Figure A.9-7.	Unit C horizontal hydraulic conductivities.	A.9-7
Figure A.9-8.	Unit D horizontal hydraulic conductivities.	A.9-7
Figure A.9-9.	3D groundwater model grid with zoomed-in views near Project features.	A.9-8
Figure A.9-10.	ET zones.	A.9-12
Figure A.9-11.	A.9-13	
Figure A.9-11.	Boundary conditions type schematic.	A.9-13
Figure A.9-12.	Major canal and reservoir stage boundary conditions for the wet & dry seasons.	A.9-15
Figure A.9-13.	Drain boundaries (model cells intersecting farm canals).	A.9-16
Figure A.9-14.	Perimeter canal reaches and weir locations.	A.9-18
Figure A.9-15.	Future Without Project Simulated Groundwater Levels in wet and dry season conditions.	A.9-20
Figure A.9-16.	Future Without Project Simulated Depth Below Ground (positive below ground, negative above ground) in wet and dry season conditions.	A.9-21
Figure A.9-17.	Head difference (Future With Project minus Future Without Project) in wet and dry season conditions for the optimized perimeter canal control elevations.	A.9-23
Figure A.9-18.	Model identifiers for the drain reaches corresponding to adjacent farm canals in Table A.9-11 and Table A.9-12.	A.9-27
Figure A.9-19.	Sensitivity of Farm Field Canal Flow to Farm Canal Properties.	A.9-30
Figure A.9-20.	Difference in Flow Extracted by Farm Canal Boundary (Drain minus River)	A.9-30
Figure A.12-1.	PS-1 Pump Station and S-84+ Spillway Site Plan.	A.12-3
Figure A.12-2.	PS-1 Pump Station Section.	A.12-5
Figure A.12-3.	S-84+ spillway section.	A.12-7
Figure A.12-4.	PS-2 Pump Station and SPS-1 Pump Station Site Plan.	A.12-9
Figure A.12-5.	PS-2 Pump Station section.	A.12-11

Figure A.12-6.	SPS-1 Pump Station section.....	A.12-13
Figure A.13-1.	Preliminary Pump Station PS-1 one-line diagram.	A.13-3
Figure A.13-2.	Preliminary Pump Stations PS-2 and SPS-1 one-line diagram.....	A.13-6
Figure A.19-1.	Sunny Day Flooding Extent from a Breach at Location 4.	A.19-3
Figure A.19-2.	Maximum Depths from a 100-year, 72-hour Rain Event.....	A.19-4
Figure A.19-3.	Difference in Maximum Depths from a 100-year, 72-hour Breach and Non-Breach Conditions at Location 4.....	A.19-5
Figure A.19-4.	Maximum Depths from a PMP Storm.	A.19-6
Figure A.19-5.	Difference in Maximum Depths from a PMP Breach and Non-Breach Conditions at Location 4.....	A.19-7

A. ENGINEERING DESIGN APPENDIX

The Engineering Appendix of the Lake Okeechobee Storage Reservoir Section 203 Study report provides a comprehensive record of the technical information and engineering analyses prepared by the South Florida Water Management District (SFWMD) to support the conceptual design of the Recommended Plan. The Engineering Appendix is organized by technical discipline and includes but is not limited to the following: an overview of the Recommended Plan features, status of engineering design activities and analyses, general construction procedures, and planning level design information for the civil-site, hydrologic, hydraulic, geotechnical, hydrogeologic, structural, architectural, mechanical, electrical, and instrumentation-and-control aspects of the Recommended Plan. For the summary of costs, cost considerations, and assumptions, refer to **Appendix B, *Cost Engineering***.

A.1 Recommended Plan

A map of the major water bodies and water management infrastructure within the vicinity of the Recommended Plan reservoir is provided in **Figure A.1-1**. The major features of the Recommended Plan are shown in yellow in **Figure A.1-2**; and are summarized in the subsections below. These features will be operated in conjunction with the local existing Central and South Florida (C&SF) Project features, labeled in **Figure A.1-1**, for the purpose of filling and emptying the storage reservoir.

A comprehensive summary table and a detailed map of the Recommended Plan project features are provided in **Table A.1-1** and **Figure A.1-4** at the end of this section. The proposed pump stations and water control structures for the Project are shown as blue symbols on the site plan. Existing local pump stations and water control structures that affect drainage patterns within the Project site, which will be modified and/or preserved as part of the Project construction, are shown as yellow symbols on the site plan. With the exception of the yellow dots representing the existing project culverts adjacent to the Project site along C-41A, the symbols for the proposed/existing water management structures shown on the site plan include an arrowhead to indicate the intended flow direction of the structure. The structures designed for bi-directional flow are shown with two arrowheads in opposite directions. The site plan shown in **Figure A.1-4**, along with site plans and sections for specific structures, a section location plan, and typical sections for earthwork for the Recommended Plan are included in **Annex C-1**.

During the planning, engineering, and design phase of the Project, the location and design of each Recommended Plan feature will be refined and optimized. This optimization may include adjustments to the size and layout of the reservoir, as well as the relocation, addition, removal, and/or combination of some water control structures and conveyance features.

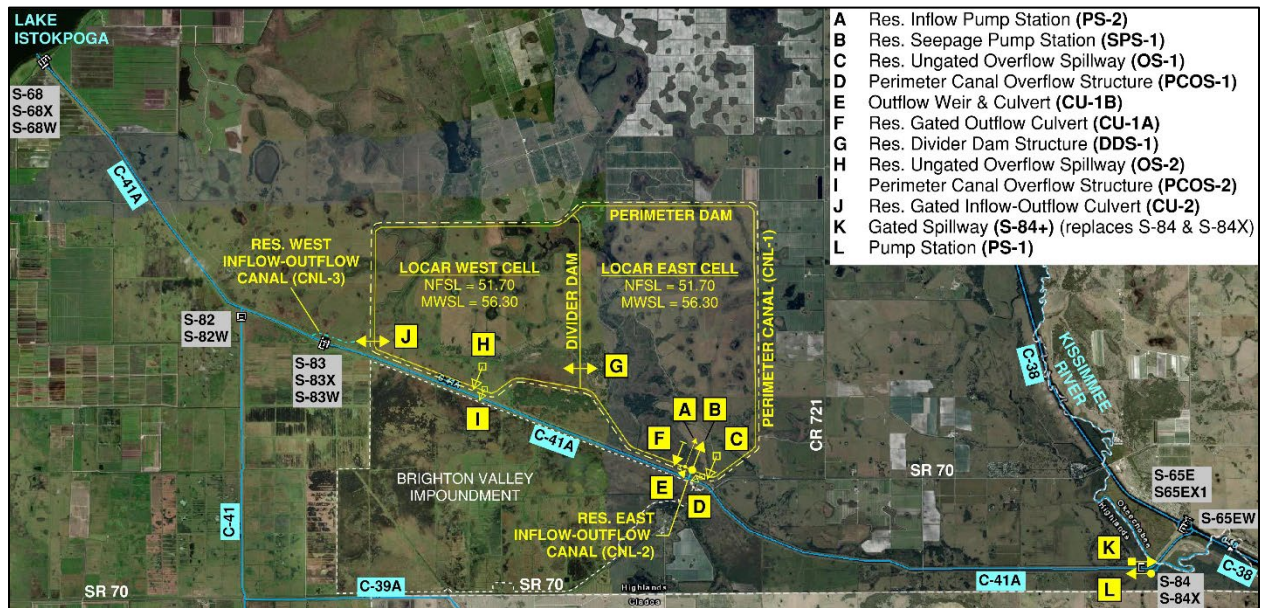

Figure A.1-1. Vicinity Map for Recommended Plan.**Figure A.1-2. Recommended Plan major Project features map.**

The location of the two reservoir gated outflow culverts, CU-1A and CU-2, allows for water to be released from the reservoir into the C-41A upstream and/or downstream of S-83/S-83X, to convey water to the Indian Prairie Sub-basin, via C-41A, C-41, C-39A, C-40 and/or C-38, as well as to Lake Okeechobee. CU-1A and CU-2 are each designed to provide a maximum outflow rate of 1,500 cubic feet per second (cfs).

During times when water is to be conveyed into the reservoir for storage, depending on the current and forecasted water management needs within the Study Area, the reservoir would be filled up to a level not to exceed its normal full storage level (NFSL) of 51.7 feet North Atlantic Vertical Datum of 1988 (NAVD88), through one or a combination of the methods outlined below.

LOCAR Filling Method 1:

Method 1 includes the full or partial diversion of flow in C-41A, downstream of S-83/S-83X, into the reservoir at a maximum rate of 1,500 cfs by operating pump station PS-2. During reservoir filling operations, S-68, S-68X, S-82, S-83, S-83X and S84+ would be operated as needed to maintain the stage within each reach of C-41A within its normal operating range. For full diversion of C-41A flow, downstream of S-83/S-83X, into the reservoir, the S-84+ spillway gates would remain closed during reservoir filling operations. For partial diversion of C-41A flow, downstream of S-83/S-83X into the reservoir, one or more of the S-84+ spillway gates would remain open during reservoir filling operations.

LOCAR Filling Method 2:

Method 2 includes the full or partial diversion of flow in C-41A, upstream of S-83/S-83X, into the reservoir by gravity at a maximum rate of 1,500 cfs, through opening gated culvert CU-2. During reservoir filling operations, S-68, S-68X, S-82, S-83, S-83X and S84+ would be operated as needed to maintain the stage within each reach of C-41A within its normal operating range. For full diversion of C-41A flow, upstream of S-83/S-83X into the reservoir, the S-82, S-83 and S-83X spillway gates would remain closed during reservoir filling operations. For

partial diversion of C-41A flow, upstream of S-83/S-83X into the reservoir, one or more of the S-82, S-83 and/or S-83X spillway gates would remain open during reservoir filling operations.

Unlike the other two methods, this method only allows for partial filling of the reservoir up to an elevation below the headwater stage at S-83/S-83X, which normally ranges from 30.6 to 31.0 feet (ft) NAVD88. **Figure A.1-3** shows the variation of the ground surface elevation across the reservoir site. Water conveyed to the reservoir through this method would be stored mostly within the southern portions of each storage cell where the ground surface is the lowest. Stage-storage calculations for the Recommended Plan indicate that there is about 6,600 acre-feet (ac-ft) of above-ground storage capacity in the reservoir at elevation 31.0 ft NAVD88 (3,800 ac-ft in east cell and 2,800 ac-ft in west cell), which is about 3 percent of the reservoir's total storage capacity of 200,000 ac-ft at its NFSL of 57.1 ft NAVD88.

LOCAR Filling Method 3:

Method 3 includes the back-pumping of water from Lake Okeechobee through C-38 and C-41A into the reservoir at a maximum rate of 1,500 cfs, by operating pump stations PS-1 and PS-2 concurrently. The first pump station, PS-1, to be located at the existing S-84 site, would move water in C-41A from the downstream (tailwater) side of the existing S-84 site into C-41A on the upstream (headwater) side of the existing S-84 site. The second pump station, PS-2, to be located between the reservoir's east cell and C-41A, would pump water from C-41A via the reservoir east inflow-outflow canal (CNL-2), directly into the reservoir's east cell. During reservoir filling operations, the S-84+ spillway gates would remain closed, and S-68, S-68X, S-82, S-83 and S-83X would be operated as needed to maintain the stage within each reach of C-41A within its normal operating range.

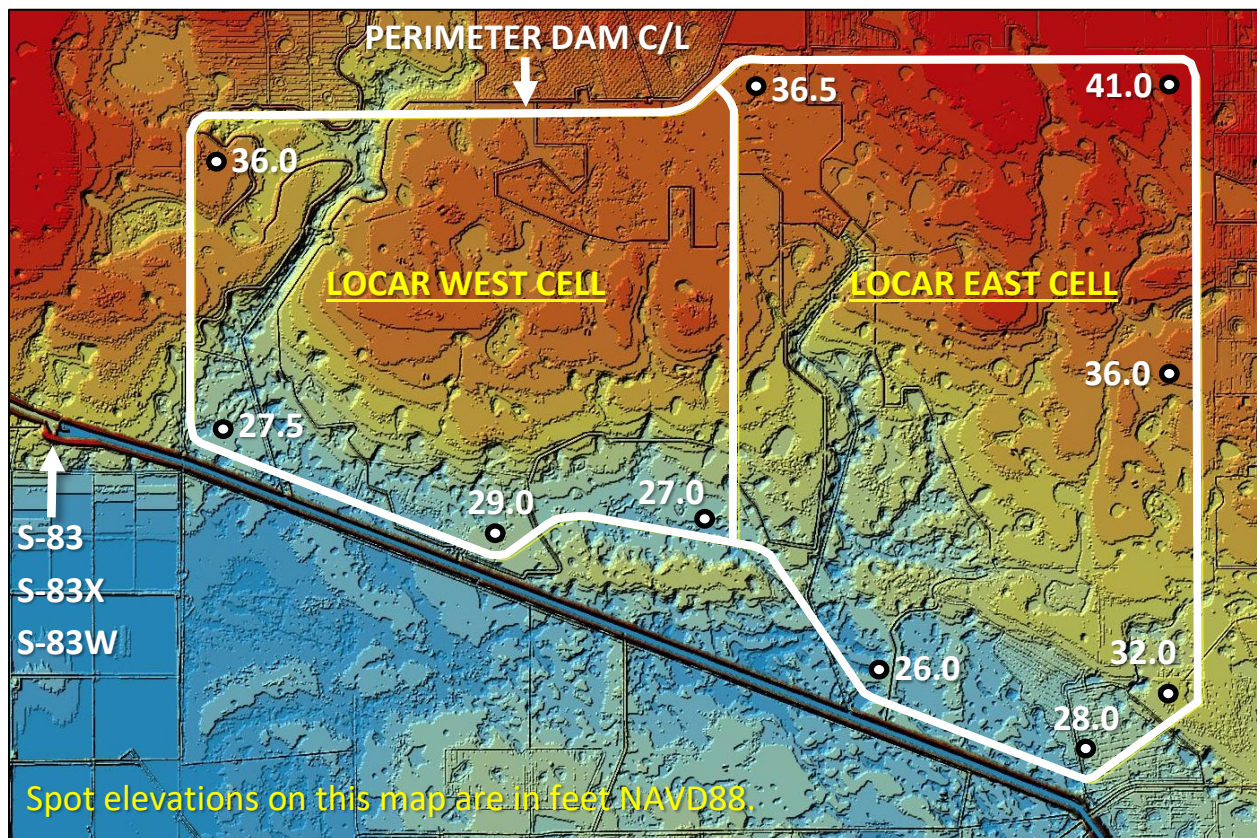

Figure A.1-3. Existing ground surface topography at the LOCAR site.

Each reservoir storage cell includes one ungated overflow spillway, designed to convey excess water in the storage cell (water within the storage cell above the NFSL) to the reservoir perimeter canal (CNL-1), to then be discharged through the perimeter canal overflow structures into C-41A. Ungated overflow spillway OS-1, to be located along the south perimeter dam of the east cell, is designed to provide a maximum outflow rate of 750 cfs. Ungated overflow spillway OS-2, to be located along the south perimeter dam of the west cell, is designed to provide a maximum outflow rate of 750 cfs.

A.1.1 Proposed Storage Reservoir

The Recommended Plan includes the construction of a 200,000 ac-ft, aboveground storage reservoir along the north side of C-41A with an inflow pump station (PS-2), gated gravity outflow structures (CU-1A, CU-1B and CU-2) and ungated overflow structures (OS-1 and OS-2). CU-2 can also function as a gated gravity inflow structure for the reservoir.

The reservoir site, which includes the reservoir and its external features, including its perimeter canal, perimeter maintenance road, east inflow-outflow canal, and west inflow-outflow canal, would encompass an area of approximately 12,554 ac (19.62 square miles [mi²]) outside of the C-41A right-of-way, of which the reservoir would occupy an area (within the centerline of its perimeter dam) of approximately 11,320 ac (17.69 mi²). The reservoir site area of approximately 12,554 ac, is the area of the proposed property boundary for the permanent features of the reservoir site, outside of the C-41A right-of-way; which includes approximately 12,482 acres of land to be acquired within the Basinger Tract, currently owned by Lykes Brothers, Inc., and 72 acres of land, currently owned by RU-MAR, Inc., to be acquired along the north side of the C-41A right-of-way, west of the Basinger Tract. The reservoir site area (approximately 12,554 acres) does not include the 474-acre cutout for the environmentally sensitive area (highlighted in yellow and labeled as ODA 7A on **Figure A.1-4**), nor does it include the 176-acre temporary construction office and staging area for the Project (crosshatched in red on **Figure A.1-4**). The reservoir's east and west storage cells will have an area (within the centerline of their perimeter and divider dams) of approximately 6,541 ac (10.22 mi²) and 4,779 ac (7.47 mi²), respectively. At its NFSL of 51.70 ft NAVD88, the reservoir will have an average storage depth of approximately 18 ft within each of its two storage cells since the average ground surface elevation within the storage cells is about 33.9 ft NAVD88.

The reservoir's major features, which are shown in **Figure A.1-2**, include:

- A perimeter dam and interior divider dam will form the east and west storage cells.
- A perimeter canal will collect and convey stormwater and reservoir seepage flows (CNL-1).
- A reservoir east inflow-outflow canal (CNL-2) will convey flows between the reservoir and C-41A, downstream of S-83.
- A reservoir west inflow-outflow canal (CNL-3) will convey flows between the reservoir and C-41A, upstream of S-83.
- There will be a gated water control structure within the divider dam (DDS-1) for stage equalization between cells when the DDS-1 gates are kept open during normal operations, or for isolation of one cell from another when the DDS-1 gates are closed. The ability to isolate one cell from another, will allow for one cell to be dewatered, such as for maintenance/inspection operations, without requiring that the other cell be dewatered. However, when the DDS-1 gates are closed, and a storage cell is taken out of service, the

reservoir's filling and emptying operations will be limited to the operational capability of the storage cell and its structures that remain in service, until the DDS-1 gates are opened allowing for the reservoir to resume normal operations.

- The reservoir inflow pump station (PS-2), with a maximum design pumping capacity of 1,500 cfs, for pumping water from C-41A, via CNL-2, into the reservoir. PS-2 will include four electric motor driven 375 cfs pumps.
- The reservoir seepage return pump station (SPS-1), with a maximum design pumping capacity of 100 cfs, will be included for pumping reservoir seepage water collected in the perimeter canal (CNL-1) back to the reservoir's storage cells. SPS-1 will include two electric motor driven 50 cfs pumps, and one electric motor driven auxiliary 50 cfs pump.
- There will be an east cell gated-outflow-culvert (CU-1A) with a downstream perimeter canal gated-outflow-culvert (CU-1B) for controlled releases at a maximum rate of 1,500 cfs to C-41A, downstream of S-83, via CNL-2
- In the west cell, there will be a gated inflow-outflow culvert (CU-2) for controlled releases at a maximum rate of 1,500 cfs to C-41A, upstream of S-83, via CNL-3. When the S-83 headwater stage is higher than the reservoir west storage cell stage, CU-2 may be operated to allow for water from C-41A, upstream of S-83, to be conveyed into the reservoir west storage cell, via CNL-3.
- The east cell will include an ungated overflow spillway (OS-1) to convey stormwater overflows out of the reservoir and ultimately into C-41A, via discharge to CNL-1, followed by discharge through PCOS-1 into CNL-2. OS-1 is designed to provide a maximum outflow rate of 750 cfs.
- The west cell will have an ungated overflow spillway (OS-2) to convey stormwater overflows out of the reservoir and ultimately into C-41A, via discharge to CNL-1, followed by discharge through PCOS-2. OS-2 is designed to provide a maximum outflow rate of 750 cfs.

The planning level 3D seepage modeling for the project described in **Section A.9** shows that, under the wet and dry season simulations when the reservoir is at its NFSL of 51.7 ft NAVD88, that the Perimeter Canal (CNL-1) will collect seepage from the reservoir at a rate of 14.7 cfs and 12.8 cfs, respectively. For the purposes of this planning study, the proposed maximum flow capacity for SPS-1 was conservatively set at 100 cfs. It is expected that during the PED phase, as recommended in **Section A.9.4**, a calibrated 3D seepage model will be completed for the project, and that the maximum flow capacity for SPS-1 will be adjusted as needed based on the updated modelled seepage flows from the reservoir.

As part of the construction of the reservoir, the southernmost AGI within the Basinger Tract, R12, will be removed/demolished along with its two inflow pump stations and outfall structure. AGI R12 has an area of approximately 900 acres (ac) and is part of the permitted stormwater management system (SFWMD surface water management permit number 28-00146-S) that serves the citrus groves within the Basinger Tract, on the north side of the Project site. To ensure that this existing stormwater management system continues to function as permitted, it is proposed that a new AGI inflow pump station (AGI-PS-2) be constructed which will discharge to AGI R11; and a new AGI (AGI-1) be constructed, including an inflow pump station (AGI-PS-1) and outfall structure (AGI-OS-1), as shown on **Figure A.1-4**, to replace AGI R12 and its structures. During the PED phase of the Project, the design of these proposed modifications to the

Basinger Tract stormwater management system will be finalized based on additional review and coordination with the Basinger Tract property owner.

A.1.2 Proposed Improvements at S-84 Site

The Recommended Plan includes the replacement of gated spillways S-84 and S-84X with gated spillway S-84+, along with the construction of pump station PS-1, adjacent to S-84+. The proposed features at the S-84 site, which are shown in **Figure A.1-2**, include:

- Pump station (PS-1) will include four, electric-motor 375-cfs pumps and will have a maximum design pumping capacity of 1,500 cfs for pumping water in C-41A from the downstream (tailwater) side of the existing S-84 site into the C-41A on the upstream (headwater) side of the existing S-84 site.
- A three-bay, gated spillway (S-84+), with a maximum design flow capacity of 9,000 cfs (3,000 cfs for each bay), will replace S-84 and S-84X, to maintain optimum upstream stages in the C-41A Canal, while designed to pass 100 percent of the SPF calculated peak discharge rate to C-41A (9,000 cfs) without exceeding upstream flood design stages and restricting downstream flood stages and channel velocities to non-damaging levels. See Section A.5.3.3 for more information concerning the design flow capacity of S-84+. S-84+ includes a vertical lift roller gate and ogee weir for each bay similar to the existing vertical lift roller gates and ogee weirs in operation for S-84 and S-84X.

The Florida Fish and Wildlife Conservation Commission, Manatee Carcass Recovery Locations in Florida GIS dataset (available at <https://geodata.myfwc.com>) shows multiple manatee carcass recovery locations within C-38, downstream of S-84/S-84X and S-65E/S-65EX1; therefore, PS-1 and S-84+ will be designed with appropriate permanent manatee protection measures. Also, during the demolition of S-84/S-84X and the construction of PS-1 and S-84+, appropriate temporary manatee protection measures will be provided within the C-41A canal right-of-way, in accordance with the environmental permitting requirements for this work and SFWMD standards, including but not necessarily limit to the following SFWMD standard specification sections:

- Section 01530 Temporary Barriers and Controls
- Section 01531 Manatee Protection
- Section 02435 Turbidity Control and Monitoring
- Section 02436 Environmental Protection

A.1.3 Potential Relocation of S-83 for Consideration/Evaluation During the PED Phase

The Recommended Plan may include the relocation of S-83 to a new location within C-41A, about 1.2 miles downstream of S-83's current location.

S-83 was put into service in 1969 and has outlived its original service life of 50 years. SFWMD's most recent structure inspection report for S-83, dated September 20, 2021, reveals that among other deficiencies, the structure has concrete deterioration below the water surface and within the splash zone. The report characterizes the condition of S-83 with an overall structure rating of C-4, which means that the structure has deficiencies that if not corrected in a timely manner could impact the operation of the structure. **Table A.1-0** provides a description of the SFWMD's overall structure rating scale. Given the

age of the S-83 and the severity of its deficiencies, SFWMD has this structure designated for full replacement under an upcoming project (separate from the LOCAR project) in its Capital Projects List.

Table A.1-0. SFWMD Overall Structure Rating Scale.

Overall Rating	Description	Application
C-1	All old deficiencies noted from the previous inspection have been corrected.	Applied when no further action is recommended for the structure.
C-2	Most old deficiencies noted from the previous inspection have been corrected.	Applied when the overall recommendation is to monitor minor deficiencies. Deficiencies will generally be re-evaluated at the next 5-year inspection of the structure.
C-3	Deficiencies have been identified and/or several old deficiencies noted in the last inspection have not been corrected.	Applied when the overall recommendation is to correct deficiencies.
C-4	Serious deficiencies exist that if not immediately corrected may lead to or cause deterioration of the structure.	Applied when the overall recommendation is to correct major deficiencies that if not corrected in a timely manner will impact the operation of the structure.
C-5	Major deficiencies exist such that the structural integrity of the structure will not likely withstand a major flood event.	Applied when the overall recommendation is to correct major deficiencies as soon as possible to restore structural integrity.
C-5 Critical	Emergency deficiencies exist that must be addressed immediately. Deficiencies include those that impede operation of the structure or jeopardize public safety.	Applied when immediate repairs are recommended in order to restore operational capability or address public safety issues. Generally, the District would respond by dispatching its Field Station personnel to triage the deficiency (e.g., block access to the structure, reduced structure operating capacity) until repairs can be performed. Responding District design engineers would be altered to fast-track repairs if triage does not ameliorate the deficiencies.

Relocating S-83 as part of the Recommended Plan, instead of simply replacing it with a new spillway structure at its current location as part of another project, would eliminate some construction and land acquisition costs of the Recommended Plan, including the cost to construct a reservoir inflow-outflow canal with a culvert connection to C-41A, and purchasing about 72 acres of pasture land within the property currently owned by RU-MAR, Inc.. However, the relocation of S-83 would include the additional cost of demolishing project culvert PC20N and structures S-83, S-83X, and S-83W. Finally, it would include the additional cost to construct a new three-gated S-83 spillway in C-41A, about 1.2 miles downstream of S-83's current location.

The potential relocation of S-83 may include the following operational benefits:

- Existing S-83X has a maximum permissible head difference (i.e., maximum permissible headwater-tailwater stage difference) of 11 ft. Under normal operations of C-41A, the head difference across S-83/S-83X can range from 6.6 to 7.9 ft. A new S-83 could be designed to have a greater maximum permissible head difference, to allow for more operational flexibility within C-41A, which could benefit the Indian Prairie Sub-basin, especially during extreme events.
- Existing S-83 and S-83X have a combined design flow capacity of 4,830 cfs. The new S-83 could be designed to have a greater design flow capacity, with less-restrictive maximum allowable gate

opening (MAGO) curves, to allow for more operational flexibility within C-41A, which could benefit the Indian Prairie Sub-basin, especially during extreme events.

The relocation of S-83 will be further evaluated during the PED phase of the project.

A.1.4 Potential Elimination of SPS-1 for Consideration/Evaluation During the PED Phase

The concept of modifying the Recommended Plan, by eliminating SPS-1 and allowing seepage water from the reservoir that collects in the perimeter canal to normally overflow by gravity via one or more fixed weir structures into the C-41A canal was discussed by the project team during the FS. Under this scenario, seepage losses from the reservoir would be replenished by pumping water from C-41A into the Reservoir via PS-2 (which under this scenario PS-2 may include one or more seepage pumps), rather than pumping water from the perimeter canal into the reservoir via SPS-1. It was decided that for the purposes of the FS, that SPS-1 would remain as part of the Recommended Plan. This alternative seepage management approach will be further evaluated during the PED phase of the project. It is recommended that further evaluation of this seepage management approach be based on the results of a calibrated 3D seepage model for the project, as recommended in **Section A.9.4**.

Table A.1-1. Summary of Recommended Plan Project Features.

Feature ID	Feature Owner, Operator & Maintainer	Feature Description and Purpose	Design Capacity	Location	Electrical Service Required ?	Notes
AGI-1	Private Landowner	Above ground impoundment (AGI) to replace existing AGI R12	Storage capacity to be coordinated with and approved by landowner in accordance with the modification to SFWMD Permit No. 28-00146-S required for the construction and operation of AGI-1	N side of West Cell	No	During the preconstruction engineering and design (PED) phase, the design of AGI-1 will be coordinated with and approved by the landowner of the property where AGI-1 will be located.
AGI-OS-1	Private Landowner	AGI-1 Outfall Structure to attenuate stormwater discharge from AGI-1 to CNL-1 Reach 1B	Flow capacity to be coordinated with and approved by landowner in accordance with the modification to SFWMD Permit No. 28-00146-S required for the construction and operation of AGI-OS-1	S side of AGI-1	No	AGI-OS-1 will be a fixed weir outfall control structure with a bleeder, similar to the outfall control structure for existing AGI R12. Invert elevation of the bleeder will be the control elevation of AGI-1, which will not be lower than the estimated seasonal high-water table (SHWT) elevation of the existing wetland within the AGI-1 site, nor will it be lower than the highest seasonal control elevation for CNL-1 Reach 1B. During the PED phase, the design of AGI-OS-1 will be coordinated with and approved by the landowner of the property where AGI-OS-1 will be located.
AGI-PS-1	Private Landowner	AGI-1 Inflow Pump Station	Pumping Capacity to be coordinated with and approved by landowner in accordance with the modification to SFWMD Permit No. 28-00146-S required for the construction and operation of AGI-PS-1	SE side of AGI-1	No	AGI-PS-1 will be the inflow pump station for AGI-1. AGI-PS-1 will replace existing AGI R12 west inflow pump station, since the Project includes the removal of AGI R12, its two inflow pump stations, and outfall structure. AGI-PS-1 will have one or more diesel engine driven pumps. During the PED phase, the design of AGI-PS-1, including its total pumping capacity and mix of pumps, will be coordinated with and approved by the landowner of the property where AGI-PS-1 will be located. Reuse of any components of existing AGI R12 pump stations for the construction of AGI-PS-1 will be evaluated with the landowner during the PED phase.
AGI-PS-2	Private Landowner	AGI R11 Inflow Pump Station	Pumping Capacity to be coordinated with and approved by landowner in accordance with the modification to SFWMD Permit No. 28-00146-S required for the construction and operation of AGI-PS-2	SE side of Existing AGI R11	No	AGI-PS-2 will be the inflow pump station for existing AGI R11. AGI-PS-2 will replace existing AGI R12 east inflow pump station, since the Project includes the removal of AGI R12, its two inflow pump stations, and outfall structure. AGI-PS-2 will have one or more diesel engine driven pumps. During the PED phase, the design of AGI-PS-2, including its total pumping capacity and mix of pumps, will be coordinated with and approved by the landowner of the property where AGI-PS-2 will be located. Reuse of any components of existing AGI R12 pump stations for the construction of AGI-PS-2 will be evaluated with the landowner during the PED phase.
Existing AGI R11 Outfall	Private Landowner	Existing AGI R11 Outfall Structure to attenuate stormwater discharge from existing AGI R11 to CNL-1 Reach 2A	Flow capacity to be coordinated with and approved by landowner in accordance with the modification to SFWMD Permit No. 28-00146-S required for any modifications to the AGI R11 Outfall	S side of AGI R11	No	The existing AGI R11 outfall control structure will be modified as needed to accommodate the additional inflow to AGI R11 from AGI-PS-2. Invert elevation of its bleeder will be the control elevation of AGI R11, which will not be lower than the estimated SHWT elevation of the existing wetland within the AGI R11 site, nor will it be lower than the highest seasonal control elevation for CNL-1 Reach 2A. During the PED phase, the design of any modifications to the existing AGI R11 outfall control structure will be coordinated with and approved by the landowner of the property where this outfall is located.
BR-1	SFWMD	Bridge over the Reservoir East Inflow-Outflow Canal (CNL-2)	See text in the Notes cell	SE side of East Cell	No	Bridge configuration must maintain a minimum of 2 ft of vertical clearance between the bridge low member elevation and the design high water level of the reservoir east inflow-outflow canal (CNL-2). Bridge will have single travel lane; and be designed for LRFD HL-93 loading or SFWMD 44-ton, 55-ton, 60-ton, and newer truck crane loading with simultaneous 640 plf AASHTO distributed lane load, whichever loading is greater.
CNL-1	SFWMD	Reservoir Perimeter Canal to collect and convey reservoir seepage outflows and stormwater runoff from the reservoir site and surrounding properties that historically drain to the reservoir site	100-Year, 3-Day Design Storm Peak Discharge Rate + Seepage Peak Flowrate to CNL-1, as well as flow capacity needed to meet GM #3, Section 3.11 Savings Clause requirements ^{3/}	Reservoir perimeter	No	The adjustable perimeter canal weirs (PCW-1 through PCW-10) divide CNL-1 into ten reaches. The adjustable perimeter canal weirs allow for the stage within each reach of CNL-1 to be adjusted as needed within the allowable limits in Table C-4 of Annex C to: 1) minimize seepage impacts within and outside the reservoir site (per Sections C.15 and C.16 of Annex C), and 2) perform pre-storm/storm operations (per Sections C.8.1, C.8.2 and C.16 of Annex C).
CNL-2	SFWMD	Reservoir East Inflow-Outflow Canal for conveyance from C-41A to PS-2 intake; and conveyance of outflows from CU-1B and PCOS-1 to C-41A	1,500 cfs	SE side of East Cell	No	

Feature ID	Feature Owner, Operator & Maintainer	Feature Description and Purpose	Design Capacity	Location	Electrical Service Required ?	Notes
CNL-3	SFWMD	Reservoir West Inflow-Outflow Canal for reservoir water supply releases to C-41A, upstream of S-83, and inflow to the reservoir West Cell	1,500 cfs	SW side of West Cell	No	Releases from reservoir West Cell will outflow from CU-2 to CNL-3, which in turn will outflow to C-41A via CU-3. Water conveyance from C-41A, upstream of S-83, to reservoir West Cell, will flow from C-41A to CNL-3 via CU-3, which in turn will flow through CU-2 to the reservoir West Cell.
CU-1A	SFWMD	Reservoir Outflow Gated Culvert for reservoir water supply releases to C-41A, downstream of S-83	1,500 cfs	SE side of East Cell	Yes	Outflow from CU-1A to CNL-1 Reach 7 will be conveyed by CU-1B to CNL-2, which in turn will outflow to C-41A.
CU-1B	SFWMD	Reservoir Outflow Weir and Culvert for reservoir water supply releases to C-41A, downstream of S-83	1,500 cfs	SE side of East Cell	Yes	Outflow from CU-1A to CNL-1 Reach 7 will be conveyed by CU-1B to CNL-2, which in turn will outflow to C-41A.
CU-2	SFWMD	Reservoir Inflow-Outflow Gated Culvert for reservoir water supply releases to C-41A, upstream of S-83, and inflow to the reservoir West Cell	1,500 cfs	SW side of West Cell	Yes	Releases from reservoir West Cell, will outflow from CU-2 to CNL-3, which in turn will outflow to C-41A via CU-3. Water conveyance from C-41A, upstream of S-83, to reservoir West Cell, will flow from C-41A to CNL-3 via CU-3, which in turn will flow through CU-2 to the reservoir West Cell.
CU-3	SFWMD	Reservoir Inflow-Outflow Ungated Culvert for reservoir water supply releases to C-41A, upstream of S-83, and inflow to the reservoir West Cell	1,500 cfs	C-41A, upstream of S-83	No	Releases from reservoir West Cell, will outflow from CU-2 to CNL-3, which in turn will outflow to C-41A via CU-3. Water conveyance from C-41A, upstream of S-83, to reservoir West Cell, will flow from C-41A to CNL-3 via CU-3, which in turn will flow through CU-2 to the reservoir West Cell.
DDS-1	SFWMD	Reservoir Divider Dam Gated Control Structure	1,500 cfs	S side of Divider Dam	Yes	DDS-1 gates will normally remain open to allow for the stage in the East Cell and West Cell to equalize. DDS-1 gates will be closed to allow for dewatering of the East Cell or West Cell for maintenance operations.
LOCAR	SFWMD	Lake Okeechobee Component A Reservoir	200,000 ac-ft	N side of C-41A	Yes	Summary of LOCAR features provided in this table. Layout of LOCAR features shown in Figure A.1-4 .
ODCD-1	SFWMD	Offsite Drainage Collection Ditch No. 1 for collecting runoff from Offsite Drainage Area No. 7A and conveying it to C-41A via ODCD-OS-1 and the outflow structures along CNL-1 Reach 7	100-Year, 3-Day Design Storm Peak Discharge Rate + Seepage Peak Flowrate to CNL-1, as well as flow capacity needed to meet GM #3, Section 3.11 Savings Clause requirements ^{3/}	S side of Reservoir	No	ODCD-1 extends from the west end of PCCU-2 to the east end of PCCU-4.
ODCD-2	Private Landowner	Offsite Drainage Collection Ditch No. 2 for collecting runoff from Offsite Drainage Area No. 7B and conveying it to CNL-1 Reach 7 via OOS-7	10-Year, 3-Day Design Storm Peak Discharge Rate, as well as flow capacity needed to meet GM #3, Section 3.11 Savings Clause requirements ^{3/}	SW side of West Cell	No	During the PED phase, the design of ODCD-2 will be coordinated with and approved by the landowner of the property where ODCD-2 will be located.
ODCD-3	Private Landowner	Offsite Drainage Collection Ditch No. 3 for collecting runoff from Offsite Drainage Area No. 8 and conveying it to CNL-1 Reach 1B via OOS-8	10-Year, 3-Day Design Storm Peak Discharge Rate, as well as flow capacity needed to meet GM #3, Section 3.11 Savings Clause requirements ^{3/}	NW side of West Cell	No	During the PED phase, the design of ODCD-3 will be coordinated with and approved by the landowner of the property where ODCD-2 will be located.
ODCD-OS-1	SFWMD	Offsite Drainage Collection Ditch No. 1 Outfall Structure that discharges to PC15N	100-Year, 3-Day Design Storm Peak Discharge Rate + Seepage Peak Flowrate to CNL-1, as well as flow capacity needed to meet GM #3, Section 3.11 Savings Clause requirements ^{3/}	S side of East Cell	No	ODCD-OS-1 will be a fixed weir overflow structure for ODCD-1 and CNL-1 Reach 7 that will outflow to existing FBR structure PC15N via a ditch, which in turn will outflow to C-41A. Preliminary crest elevation of the fixed weir is 25.5 ft NAVD88, which may be revised during the PED phase.
OOS-1	Private Landowner	Offsite Outfall Structure for Offsite Drainage Area No. 1 (adjacent wetland) that will discharge to CNL-1 Reach 2B.	10-Year, 3-Day Design Storm Peak Discharge Rate, as well as flow capacity needed to meet GM #3, Section 3.11 Savings Clause requirements ^{3/}	N side of East Cell	No	OOS-1 will be a fixed weir outfall control structure with a bleeder. Invert elevation of bleeder will not be lower than the estimated SHWT elevation of the existing wetland that will drain to OOS-1, nor will it be lower than the highest seasonal control elevation for CNL-1 Reach 2B. During the PED phase, the design of OOS-1 will be coordinated with and approved by the landowner of the property where OOS-1 will be located.

Feature ID	Feature Owner, Operator & Maintainer	Feature Description and Purpose	Design Capacity	Location	Electrical Service Required ?	Notes
OOS-2	Private Landowner	Offsite Outfall Structure for Offsite Drainage Area No. 2 (adjacent wetland) that discharges to CNL-1 Reach 2B.	10-Year, 3-Day Design Storm Peak Discharge Rate, as well as flow capacity needed to meet GM #3, Section 3.11 Savings Clause requirements ^{3/}	N side of East Cell	No	OOS-2 will be a fixed weir outfall control structure with a bleeder. Invert elevation of bleeder will not be lower than the estimated SHWT elevation of the existing wetland that will drain to OOS-2, nor will it be lower than the highest seasonal control elevation for CNL-1 Reach 2B. During the PED phase, the design of OOS-2 will be coordinated with and approved by the landowner of the property where OOS-2 will be located.
OOS-3	Private Landowner	Offsite Outfall Structure for Offsite Drainage Area No. 3 (adjacent wetland) that discharges to CNL-1 Reach 2B.	10-Year, 3-Day Design Storm Peak Discharge Rate, as well as flow capacity needed to meet GM #3, Section 3.11 Savings Clause requirements ^{3/}	N side of East Cell	No	OOS-3 will be a fixed weir outfall control structure with a bleeder. Invert elevation of bleeder will not be lower than the estimated SHWT elevation of the existing wetland that will drain to OOS-3, nor will it be lower than the highest seasonal control elevation for CNL-1 Reach 2B. During the PED phase, the design of OOS-3 will be coordinated with and approved by the landowner of the property where OOS-3 will be located.
OOS-4	Private Landowner	Offsite Outfall Structure for Offsite Drainage Area No. 4 (adjacent wetland) that discharges to CNL-1 Reach 4.	10-Year, 3-Day Design Storm Peak Discharge Rate, as well as flow capacity needed to meet GM #3, Section 3.11 Savings Clause requirements ^{3/}	E side of East Cell	No	OOS-4 will be a fixed weir outfall control structure with a bleeder. Invert elevation of bleeder will not be lower than the estimated SHWT elevation of the existing wetland that will drain to OOS-4, nor will it be lower than the highest seasonal control elevation for CNL-1 Reach 4. During the PED phase, the design of OOS-4 will be coordinated with and approved by the landowner of the property where OOS-4 will be located.
OOS-5	Private Landowner	Offsite Outfall Structure for Offsite Drainage Area No. 5 (adjacent agricultural land) that discharges to CNL-1 Reach 6.	10-Year, 3-Day Design Storm Peak Discharge Rate, as well as flow capacity needed to meet GM #3, Section 3.11 Savings Clause requirements ^{3/}	E side of East Cell	No	OOS-5 will be a fixed weir outfall control structure with a bleeder. Invert elevation of bleeder will not be lower than the surface water control elevation of the existing agricultural land that will drain to OOS-5, nor will it be lower than the highest seasonal control elevation for CNL-1 Reach 6. During the PED phase, the design of OOS-5 will be coordinated with and approved by the landowner of the property where OOS-5 will be located.
OOS-6	Private Landowner	Offsite Outfall Structure for Offsite Drainage Area No. 6 (adjacent agricultural land) that discharges to CNL-1 Reach 6.	10-Year, 3-Day Design Storm Peak Discharge Rate, as well as flow capacity needed to meet GM #3, Section 3.11 Savings Clause requirements ^{3/}	E side of East Cell	No	OOS-6 will be a fixed weir outfall control structure with a bleeder. Invert elevation of bleeder will not be lower than the surface water control elevation of the existing agricultural land that will drain to OOS-6, nor will it be lower than the highest seasonal control elevation for CNL-1 Reach 6. During the PED phase, the design of OOS-6 will be coordinated with and approved by the landowner of the property where OOS-6 will be located.
OOS-7	Private Landowner	Offsite Outfall Structure for Offsite Drainage Area No. 7B (adjacent agricultural land) that discharges to CNL-1 Reach 7.	10-Year, 3-Day Design Storm Peak Discharge Rate, as well as flow capacity needed to meet GM #3, Section 3.11 Savings Clause requirements ^{3/}	W side of West Cell	No	OOS-7 will be a fixed weir outfall control structure with a bleeder. Invert elevation of bleeder will not be lower than the surface water control elevation of the existing agricultural land that will drain to OOS-7, nor will it be lower than the highest seasonal control elevation for CNL-1 Reach 7. During the PED phase, the design of OOS-7 will be coordinated with and approved by the landowner of the property where OOS-7 will be located.
OOS-8	Private Landowner	Offsite Outfall Structure for Offsite Drainage Area No. 8 (adjacent agricultural land) that discharges to CNL-1 Reach 1B.	10-Year, 3-Day Design Storm Peak Discharge Rate, as well as flow capacity needed to meet GM #3, Section 3.11 Savings Clause requirements ^{3/}	NW side of West Cell	No	OOS-8 will be a fixed weir outfall control structure with a bleeder. Invert elevation of bleeder will not be lower than the surface water control elevation of the existing agricultural land that will drain to OOS-8, nor will it be lower than the highest seasonal control elevation for CNL-1 Reach 1B. During the PED phase, the design of OOS-8 will be coordinated with and approved by the landowner of the property where OOS-8 is will located.
OS-1	SFWMD	Reservoir Ungated Overflow Spillway for East Cell	750 cfs	S side of East Cell	No	Outflow from OS-1 to CNL-1 Reach 7 will be conveyed to C-41A mostly by PCOS-1, which will outflow to CNL-2, which in turn will outflow to C-41A.
OS-2	SFWMD	Reservoir Ungated Overflow Spillway for West Cell	750 cfs	S side of West Cell	No	Outflow from OS-2 to CNL-1 Reach 7 will be conveyed to C-41A mostly by PCOS-2, which will outflow to C-41A.
Existing PC15N	SFWMD	Existing Project Culvert PC15N	30% SPF Peak Discharge Rate (per Corps C-41A Design Memoranda)	S side of East Cell	No	Existing channel on the upstream side of PC15N will be improved as needed (e.g. increase flow capacity and armor with revetment) to safely convey outflows from ODCD-OS-1 to existing Project Culvert PC15N.
Existing PC18N	SFWMD	Existing Project Culvert PC18N	30% SPF Peak Discharge Rate (per Corps C-41A Design Memoranda)	S side of West Cell	No	Existing channel on the upstream side of PC18N will be improved as needed (e.g. increase flow capacity and armor with revetment) to safely convey outflows from PCOS-3 to existing Project Culvert PC18N.

Feature ID	Feature Owner, Operator & Maintainer	Feature Description and Purpose	Design Capacity	Location	Electrical Service Required ?	Notes
Existing PC20N	SFWMD	Existing Project Culvert PC20N	30% SPF Peak Discharge Rate (per Corps C-41A Design Memoranda)	S side of West Cell	No	Existing channel on the upstream side of PC20N will be improved as needed (e.g. increase flow capacity and armor with revetment) to safely convey outflows from PCOS-4 to existing Project Culvert PC20N.
PCCU-1	SFWMD	Reservoir Perimeter Canal Ungated Culvert Crossing	100-Year, 3-Day Design Storm Peak Discharge Rate + Seepage Peak Flowrate to CNL-1, as well as flow capacity needed to meet GM #3, Section 3.11 Savings Clause requirements ^{3/}	N side of Divider Dam	No	PCCU-1 supports the unpaved roadway crossing of CNL-1 Reach 2, to be located near the Divider Dam crest road north access ramp.
PCCU-2	SFWMD	Reservoir Perimeter Canal Ungated Culvert that connects to ODCD-1	100-Year, 3-Day Design Storm Peak Discharge Rate + Seepage Peak Flowrate to CNL-1, as well as flow capacity needed to meet GM #3, Section 3.11 Savings Clause requirements ^{3/}	S side of East Cell	No	PCCU-2 will be located under the reservoir perimeter maintenance road and will connect CNL-1 Reach 7 to the east end of the ODCD-1.
PCCU-3	SFWMD	Reservoir Perimeter Canal Ungated Culvert Crossing	100-Year, 3-Day Design Storm Peak Discharge Rate + Seepage Peak Flowrate to CNL-1, as well as flow capacity needed to meet GM #3, Section 3.11 Savings Clause requirements ^{3/}	S side of Divider Dam	No	PCCU-3 supports the unpaved roadway crossing of CNL-1 Reach 7, to be located near the Divider Dam crest road south access ramp.
PCCU-4	SFWMD	Reservoir Perimeter Canal Ungated Culvert that connects to ODCD-1	100-Year, 3-Day Design Storm Peak Discharge Rate + Seepage Peak Flowrate to CNL-1, as well as flow capacity needed to meet GM #3, Section 3.11 Savings Clause requirements ^{3/}	S side of West Cell	No	PCCU-4 will be located under the reservoir perimeter maintenance road and will connect CNL-1 Reach 7 to the west end of the ODCD-1.
PCOS-1	SFWMD	Reservoir Perimeter Canal Overflow Structure	PMP/PMF Peak Discharge Rate + Seepage Peak Flowrate to CNL-1, as well as flow capacity needed to meet GM #3, Section 3.11 Savings Clause requirements ^{3/}	S side of East Cell	No	PCOS-1 will be a fixed weir overflow structure for CNL-1 Reach 7 that will outflow to CNL-2, which in turn will outflow to C-41A. Preliminary crest elevation of the fixed weir is 25.5 ft NAVD88, which may be revised during the PED phase. PMP/PMF Peak Discharge Rate includes: 750 cfs outflow from reservoir storage cell(s) to PCOS-1 via OS-1 + simultaneous inflow of PMF runoff, from areas outside of the reservoir storage cells, to PCOS-1 via CNL-1.
PCOS-2	SFWMD	Reservoir Perimeter Canal Overflow Structure	PMP/PMF Peak Discharge Rate + Seepage Peak Flowrate to CNL-1, as well as flow capacity needed to meet GM #3, Section 3.11 Savings Clause requirements ^{3/}	S side of West Cell	No	PCOS-2 will be a fixed weir overflow structure for CNL-1 Reach 7 that will outflow directly to C-41A. PCOS-2 will replace existing Project Culvert PC17N. Preliminary crest elevation of the fixed weir is 25.5 ft NAVD88, which may be revised during the PED phase. PMP/PMF Peak Discharge Rate includes: 750 cfs outflow from reservoir storage cell(s) to PCOS-2 via OS-2 + simultaneous inflow of PMF runoff, from areas outside of the reservoir storage cells, to PCOS-2 via CNL-1.
PCOS-3	SFWMD	Reservoir Perimeter Canal Overflow Structure	100-Year, 3-Day Design Storm Peak Discharge Rate + Seepage Peak Flowrate to CNL-1, as well as flow capacity needed to meet GM #3, Section 3.11 Savings Clause requirements ^{3/}	S side of West Cell	No	PCOS-3 will be a fixed weir overflow structure for CNL-1 Reach 7 that will outflow to existing Project Culvert PC18N via a channel, which in turn will outflow to C-41A. Preliminary crest elevation of the fixed weir is 25.5 ft NAVD88, which may be revised during the PED phase.
PCOS-4	SFWMD	Reservoir Perimeter Canal Overflow Structure	100-Year, 3-Day Design Storm Peak Discharge Rate + Seepage Peak Flowrate to CNL-1, as well as flow capacity needed to meet GM #3, Section 3.11 Savings Clause requirements ^{3/}	S side of West Cell	No	PCOS-4 will be a fixed weir overflow structure for CNL-1 Reach 7 that will outflow to existing Project Culvert PC20N via a channel, which in turn will outflow to C-41A. Preliminary crest elevation of the fixed weir is 25.5 ft NAVD88, which may be revised during the PED phase.

Feature ID	Feature Owner, Operator & Maintainer	Feature Description and Purpose	Design Capacity	Location	Electrical Service Required ?	Notes
PCW-1	SFWMD	Reservoir Perimeter Canal Weir No. 1 to control stage in CNL-1 Reach 1A	100-Year, 3-Day Design Storm Peak Discharge Rate + Seepage Peak Flowrate to CNL-1, as well as flow capacity needed to meet GM #3, Section 3.11 Savings Clause requirements ^{3/}	W side of West Cell	No	Manually adjustable weir located at downstream end of CNL-1 Reach 1A. Allows stage within Reach 1A to be adjusted as needed within the allowable limits in Table C-4 of Annex C to: 1) minimize seepage impacts within and outside the reservoir site (per Sections C.15 and C.16 of Annex C), and 2) perform pre-storm/storm operations (per Sections C.8.1, C.8.2 and C.16 of Annex C).
PCW-2	SFWMD	Reservoir Perimeter Canal Weir No. 2 to control stage in CNL-1 Reach 1B	100-Year, 3-Day Design Storm Peak Discharge Rate + Seepage Peak Flowrate to CNL-1, as well as flow capacity needed to meet GM #3, Section 3.11 Savings Clause requirements ^{3/}	W side of West Cell	No	Manually adjustable weir located at downstream end of CNL-1 Reach 1B. Allows stage within Reach 1B to be adjusted as needed within the allowable limits in Table C-4 of Annex C to: 1) minimize seepage impacts within and outside the reservoir site (per Sections C.15 and C.16 of Annex C), and 2) perform pre-storm/storm operations (per Sections C.8.1, C.8.2 and C.16 of Annex C).
PCW-3	SFWMD	Reservoir Perimeter Canal Weir No. 3 to control stage in CNL-1 Reach 2A	100-Year, 3-Day Design Storm Peak Discharge Rate + Seepage Peak Flowrate to CNL-1, as well as flow capacity needed to meet GM #3, Section 3.11 Savings Clause requirements ^{3/}	N side of West Cell	No	Manually adjustable weir located at downstream end of CNL-1 Reach 2A. Allows stage within Reach 2A to be adjusted as needed within the allowable limits in Table C-4 of Annex C to: 1) minimize seepage impacts within and outside the reservoir site (per Sections C.15 and C.16 of Annex C), and 2) perform pre-storm/storm operations (per Sections C.8.1, C.8.2 and C.16 of Annex C).
PCW-4	SFWMD	Reservoir Perimeter Canal Weir No. 4 to control stage in CNL-1 Reach 2B	100-Year, 3-Day Design Storm Peak Discharge Rate + Seepage Peak Flowrate to CNL-1, as well as flow capacity needed to meet GM #3, Section 3.11 Savings Clause requirements ^{3/}	N side of East Cell	No	Manually adjustable weir located at downstream end of CNL-1 Reach 2B. Allows stage within Reach 2B to be adjusted as needed within the allowable limits in Table C-4 of Annex C to: 1) minimize seepage impacts within and outside the reservoir site (per Sections C.15 and C.16 of Annex C), and 2) perform pre-storm/storm operations (per Sections C.8.1, C.8.2 and C.16 of Annex C).
PCW-5	SFWMD	Reservoir Perimeter Canal Weir No. 5 to prevent CNL-1 Reach 3A from discharging to CNL-1 Reach 2B under design flow conditions	100-Year, 3-Day Design Storm Peak Discharge Rate + Seepage Peak Flowrate to CNL-1, as well as flow capacity needed to meet GM #3, Section 3.11 Savings Clause requirements ^{3/}	N side of East Cell	No	Manually adjustable weir located at upstream end of CNL-1 Reach 3A. Allows stage within Reach 3A to be adjusted as needed within the allowable limits in Table C-4 of Annex C to: 1) minimize seepage impacts within and outside the reservoir site (per Sections C.15 and C.16 of Annex C), and 2) perform pre-storm/storm operations (per Sections C.8.1, C.8.2 and C.16 of Annex C). PCW-5 weir crest to be set sufficiently higher than PCW-6 weir crest to ensure that PCW-6 is the outfall weir for Reach 3A under design flow conditions.
PCW-6	SFWMD	Reservoir Perimeter Canal Weir No. 6 to control stage in CNL-1 Reach 3A	100-Year, 3-Day Design Storm Peak Discharge Rate + Seepage Peak Flowrate to CNL-1, as well as flow capacity needed to meet GM #3, Section 3.11 Savings Clause requirements ^{3/}	NE side of East Cell	No	Manually adjustable weir located at downstream end of CNL-1 Reach 3A. Allows stage within Reach 3A to be adjusted as needed within the allowable limits in Table C-4 of Annex C to: 1) minimize seepage impacts within and outside the reservoir site (per Sections C.15 and C.16 of Annex C), and 2) perform pre-storm/storm operations (per Sections C.8.1, C.8.2 and C.16 of Annex C).
PCW-7	SFWMD	Reservoir Perimeter Canal Weir No. 7 to control stage in CNL-1 Reach 3B	100-Year, 3-Day Design Storm Peak Discharge Rate + Seepage Peak Flowrate to CNL-1, as well as flow capacity needed to meet GM #3, Section 3.11 Savings Clause requirements ^{3/}	E side of East Cell	No	Manually adjustable weir located at downstream end of CNL-1 Reach 3B. Allows stage within Reach 3B to be adjusted as needed within the allowable limits in Table C-4 of Annex C to: 1) minimize seepage impacts within and outside the reservoir site (per Sections C.15 and C.16 of Annex C), and 2) perform pre-storm/storm operations (per Sections C.8.1, C.8.2 and C.16 of Annex C).
PCW-8	SFWMD	Reservoir Perimeter Canal Weir No. 8 to control stage in CNL-1 Reach 4	100-Year, 3-Day Design Storm Peak Discharge Rate + Seepage Peak Flowrate to CNL-1, as well as flow capacity needed to meet GM #3, Section 3.11 Savings Clause requirements ^{3/}	E side of East Cell	No	Manually adjustable weir located at downstream end of CNL-1 Reach 4. Allows stage within Reach 4 to be adjusted as needed within the allowable limits in Table C-4 of Annex C to: 1) minimize seepage impacts within and outside the reservoir site (per Sections C.15 and C.16 of Annex C), and 2) perform pre-storm/storm operations (per Sections C.8.1, C.8.2 and C.16 of Annex C).

Feature ID	Feature Owner, Operator & Maintainer	Feature Description and Purpose	Design Capacity	Location	Electrical Service Required ?	Notes
PCW-9	SFWMD	Reservoir Perimeter Canal Weir No. 9 to control stage in CNL-1 Reach 5	100-Year, 3-Day Design Storm Peak Discharge Rate + Seepage Peak Flowrate to CNL-1, as well as flow capacity needed to meet GM #3, Section 3.11 Savings Clause requirements ^{3/}	E side of East Cell	No	Manually adjustable weir located at downstream end of CNL-1 Reach 5. Allows stage within Reach 5 to be adjusted as needed within the allowable limits in Table C-4 of Annex C to: 1) minimize seepage impacts within and outside the reservoir site (per Sections C.15 and C.16 of Annex C), and 2) perform pre-storm/storm operations (per Sections C.8.1, C.8.2 and C.16 of Annex C).
PCW-10	SFWMD	Reservoir Perimeter Canal Weir No. 10 to control stage in CNL-1 Reach 6	100-Year, 3-Day Design Storm Peak Discharge Rate + Seepage Peak Flowrate to CNL-1, as well as flow capacity needed to meet GM #3, Section 3.11 Savings Clause requirements ^{3/}	SE side of East Cell	No	Manually adjustable weir located at downstream end of CNL-1 Reach 6. Allows stage within Reach 6 to be adjusted as needed within the allowable limits in Table C-4 of Annex C to: 1) minimize seepage impacts within and outside the reservoir site (per Sections C.15 and C.16 of Annex C), and 2) perform pre-storm/storm operations (per Sections C.8.1, C.8.2 and C.16 of Annex C).
PS-1	SFWMD	Pump Station to be located at Existing S-84 Site	1,500 cfs	S-84 site within C-41A	Yes	PS-1 will include 4 electric motor driven pumping units, each with a design flow capacity of 375 cfs.
PS-2	SFWMD	Reservoir Inflow Pump Station	1,500 cfs	S side of East Cell	Yes	PS-2 will include 4 electric motor driven pumping units, each with a design flow capacity of 375 cfs.
S-84+	SFWMD	Spillway to replace existing S-84 and S-84X Spillway	9,000 cfs	S-84 site within C-41A	Yes	To accommodate the peak design outflow rate from LOCAR during Probable Maximum Precipitation (PMP) Scenarios 1 and 2, and improve operational flexibility of C-41A, S-84+ will have three 22' wide x 14' tall roller gates, that will provide a total design discharge capacity of 9,000 cfs.
SPS-1	SFWMD	Reservoir Seepage Pump Station for returning seepage outflow from the reservoir intercepted by CNL-1, and controlling the stage in CNL-1 Reach 7	100 cfs	S side of East Cell	Yes	SPS-1 will include 2 electric motor-driven pumping units, each with a design flow capacity of 50 cfs. SPS-1 will include an auxiliary, electric motor-driven pumping unit with a design flow capacity of 50 cfs. SPS-1 will include a back-up generator to provide electrical power to operate the seepage pumps, in the event of an electrical service outage.

1/ AASHTO—American Association of State Highway Officials; ac-ft—acre-foot; cfs—cubic feet per second; E—east; ft—foot; LRFD HL-93—Load and Resistance Factor Design Highway Load 93; N—north; NE—northeast; NW—northwest; plf—pound per linear foot; S—south; SE—southeast; SPF—Standard Project Flood; SW—southwest; W—west

2/ During the PED phase of the Project, the location and design of each Recommended Plan feature will be refined and optimized, which may include adjustments to the layout of the reservoir, as well as the relocation, addition, removal, and/or combination of some water control structures and conveyance features. Also, the naming convention of the proposed features in this table is preliminary. Each project feature will receive an official SFWMD structure name during the PED phase of the Project, which will be reflected in the updated DPOM completed during the PED phase.

3/ To ensure that the Recommended Plan will not interrupt the existing drainage pattern of the offsite drainage basins/properties that historically drain to the reservoir site (ODAs 1 through 14B identified on **Figure A.1-4**), nor increase peak flood stages within these basins/properties, the Project includes a perimeter canal (CNL-1) around the reservoir designed to simultaneously convey peak seepage flows from reservoir (intercepted by the perimeter canal as described in **Section A.9** of the LOCAR FS Report) and peak stormwater discharges from the reservoir site and adjacent offsite basins (that historically drain to the reservoir site) to C-41A. The 1D HEC-RAS-HMS H&H models presented in **Annex A-2.6** of the LOCAR FS Report were used to determine the effectiveness of the perimeter canal to meet this design intent.

In accordance with Section 3.11 of GM #3, from the CERP Programmatic Regulations, Six Program-Wide Guidance Memoranda (Corps and SFWMD 2007), during the PED phase of the Project, these 1D HEC-RAS-HMS H&H models presented in **Annex A-2.6**, will be converted to and/or replaced with 2D HEC-RAS-HMS H&H models (or other 2D H&H models approved by the Corps and District to use for the Project); and these 2D H&H models will be used to run continuous simulations for a climatic period of record, in order to address the Flood Protection Savings Clause requirements of GM #3. In addition, these 2D models will be used to run simulations that account for the effects of anticipated climate change (e.g. increases in precipitation depths of standard design storms as discussed in **Section A.5.2.2** and **Annex H** of the LOCAR FS Report). During the PED phase, a technical memorandum that summarizes this 2D H&H modeling, along with the 2D modeling files, will be submitted to the Corps, Jacksonville District for review and approval prior to finalizing the engineering design of the Project during the PED phase. Revisions to the 2D model and technical memorandum as well as revisions to the engineering design of the Project will be completed during the PED phase to address as needed any review comments from the Jacksonville District, concerning this 2D H&H modeling.

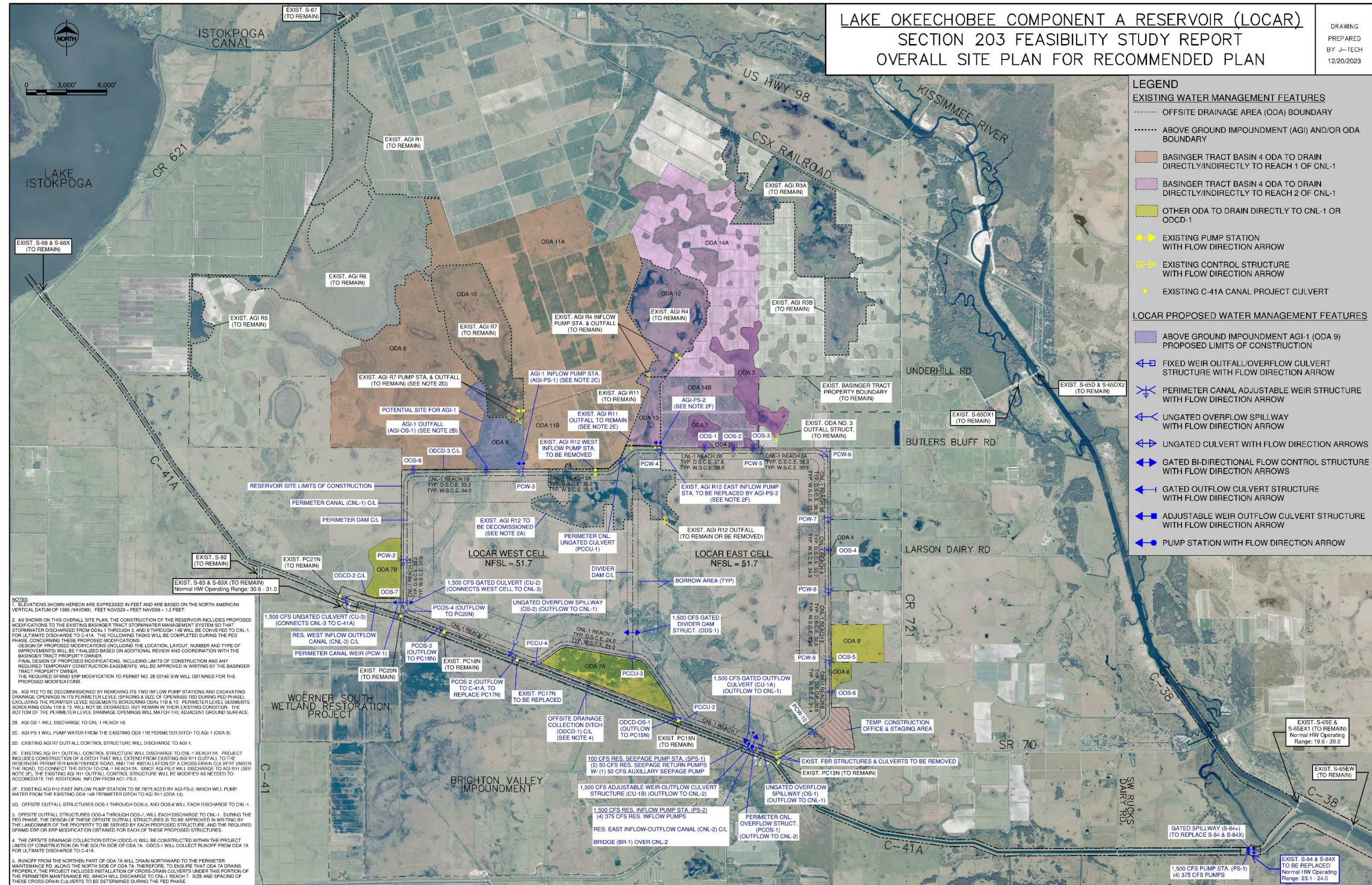

Figure A.1-4. Overall site plan of Recommended Plan.

A.2 Status of Engineering Design Activities and Analyses

A.2.1 Level of Design Efforts

Engineer Regulation (ER) 1110-2-1150, *Engineering and Design for Civil Works Projects*, provides guidance for feasibility level design to accompany decision documents. ER 1110-2-1302, *Engineering and Design for Civil Works Cost Engineering*, and CECW-EC Memorandum for Record (MFR) – Guidance on Cost Engineering Products Update for Civil Works Projects in Accordance with ER 1110-2-1302, dated June 5, 2023, provide guidance for preparing cost estimates for feasibility studies, based on the level of design maturity achieved and risk identified at the conclusion of a feasibility study. The CECW-EC MFR, dated June 5, 2023, states:

“At a minimum, the District Chief of Engineering Division, utilizing the project’s Risk Register, must address three basic areas in determining the level of design:

- a. Geotechnical data quality, likely unknowns, and risks associated with using the available data, including the risks where there is little to no data. Scope changes from unknown foundation conditions have been known to cause significant increases.
- b. Hydrology and Hydraulics (H&H) model type (e.g., 1d, 2d, 3d), if a model has been run, quality of data, and risks associated with these models.
- c. Survey data quality and risks associated with this data.”

During the preparation of the Feasibility Study (FS), the planning level engineering design for the Recommended Plan was completed in accordance with ER 1110-2-1150. Based on the scope of the engineering analyses completed and the level of design maturity achieved for the Recommended Plan’s major features (or Project components), documented in **Appendix A**, including but not limited to the level of design maturity of: the geotechnical data and subsurface investigations (**Sections A.7, A.8, A.9**), hydrology and hydraulics modeling (**Sections A.5, A.6, A.12**), and survey data (**Section A.4.2**), it was estimated that the aggregate level of engineering design maturity of the Recommended Plan completed for the FS is twenty percent.

In addition, during the FS, Project risks were identified. The risks are presented in a Project Risk Register, included in **Appendix B**. Risks to be addressed by the engineering design of the Recommended Plan from the Risk Register include:

- TD1: Internal water conveyance
- TD2: Seepage
- TD3: Flood control operations
- TD4: Pump station designs
- TD5: Global geotechnical assumptions
- TD6: On-site disposal of excess material
- TD7: System not performing as intended

- TD8: Wave wall designs (Currently not a risk because the perimeter dam no longer includes a wave wall. Could become a risk, if during the PED phase, the perimeter dam is redesigned to include a wave wall.)
- TD9: Survey
- TD10: Reorientation of divider dam
- TD11: S-83 relocation
- TD12: DCM changes/updates
- TD13: Internal drainage system (potential for clogging caused by iron ochre)
- TD14: Added project features
- TD15: Modifications to stormwater management system including modifications to Basinger Tract existing stormwater management system
- TD16: Potential switch from electric to diesel power pump stations
- TD17: Integrating tower and spillway
- TD18: Use of 1D hydrologic and hydraulic modeling
- TD19: Depth of seepage cut-off wall
- TD20: Riprap material type (limestone vs. granite)

These risks and the other risks for the Project identified in the Risk Register in Appendix B, along with the risks and recommendations identified in the Lake Okeechobee Component A Reservoir Screening Level Risk Assessment report, by the Corps, Jacksonville District, dated February 12, 2024, will be further evaluated and addressed during the PED phase of the Project.

Regarding TD13, during the PED phase of the Project, design refinements, mitigation measures and maintenance options to address the risk of the reservoir perimeter and divider dam seepage collection/drainage systems becoming clogged with iron ochre will be reviewed, evaluated, and may be incorporated into the design of the seepage collection/drainage systems. Such refinements may include, but not be limited to:

- Specifying course stone for the seepage collection pipelines with three stages/layers of filter stone and sand
- Specifying seepage collection pipelines with larger perforations/slots
- Designing the seepage collection pipelines, drainage pipelines, and toe drains to be normally submerged in water/groundwater to deprive the ochre bacteria of oxygen

As part of the construction of the reservoir perimeter and divider dams, it is envisioned that each seepage collection drain solid outlet pipe will be connected to its associated seepage collection drain perforated/slotted pipeline with a wye connector/fitting, so that each outlet pipe can function as a cleanout when maintenance cleaning of the seepage collection system is required. Refer to the Lake Okeechobee Component A Reservoir Screening Level Risk Assessment, by the Corps, Jacksonville District, dated February 12, 2024, for more information about the risk of iron ochre formation.

A.2.2 Recommendation for Design Completion

Features of the Recommended Plan have been designed based on available data, historic information, and preliminary engineering analyses and calculations. The design of these features (or Project components) will be optimized during the PED phase for cost efficiency and performance, incorporating updated data and information as it becomes available. Specific recommendations concerning the optimization of Project components and additional analyses to be completed during the PED phase are included throughout the **Appendix A** sections and annexes. During the PED phase, an economic analysis will be conducted on the components of each proposed pump station to ensure compliance with Engineering Manual (EM) 1110-2-3102.

A.3 General Construction Procedures Discussion

A.3.1 General Construction Recommendations

It is envisioned that the Recommended Plan will be constructed using conventional means and methods. The features are designed to capitalize on the use of on-site material, reduce multiple handling scenarios, utilize existing infrastructure where appropriate, and maintain flood control operations and level of service provided by existing features.

A.3.2 Construction Contracts and Schedule

It is anticipated that the Recommended Plan will be constructed under the following seven major construction contracts. During the PED phase, the specific breakdown and scheduling of the construction contracts for the Recommended Plan will be finalized, with consideration given to the risk for schedule and cost impacts resulting from the interdependencies of the contracts and potential interference or conflicts in construction operations (including but not limited to staging and site access, dewatering, and stormwater management during construction) caused by multiple construction contractors working simultaneously within the same area.

Contract 1: S-84 Site and Structures

- Demolish S-84 and S-84X; and construct S-84+ and PS-1.

Contract 2: Reservoir Inflow Pump Station Site and Structures

- Construct Pump Stations PS-2 and SPS-1.
- Construct Reservoir East Inflow-Outflow Canal CNL-2.
- Construct Bridge BR-1 over reservoir inflow-outflow canal.
- Construct Outflow Weir and Culvert CU-1B and Perimeter Canal Overflow Structure PCOS-1.

Contract 3: Reservoir Dam Foundation

- Construct reservoir perimeter and divider dam soil bentonite seepage cutoff wall below existing ground.
- Construct soil foundation/base for perimeter and divider dam.
- Soil bentonite seepage cutoff wall and soil foundation/base will be constructed with a gap (i.e., “work-around area”) at each location where an existing major drainage ditch crosses the alignment of the perimeter and divider dam, so that these existing ditches can continue to drain to C-41A (via Project culverts PC13N, PC15N, PC17N, PC18N, and PC20N), during the construction of Contract 3; and until the necessary project components and temporary drainage features are constructed under contracts 4, 5 and/or 6 to ensure proper drainage of the reservoir site and the adjacent offsite areas that discharge stormwater directly/indirectly to the reservoir site (i.e. Offsite Drainage Areas [ODAs] 1 through 14B). Once Perimeter Canal CNL-1 is constructed under Contract 4, and the other necessary drainage features are in place so that offsite drainage flow through the existing ditches within the reservoir site is no longer required, each gap in the seepage cutoff wall will be filled with a soil bentonite seepage cutoff wall section consistent with the typical section of the perimeter dam.

Contract 4: Reservoir Earthwork

- Construct reservoir earthwork features (i.e., perimeter and divider dams, toe ditch, toe road, Perimeter Canal CNL-1, perimeter maintenance road, and Offsite Drainage Collection Ditch).
- Construct Reservoir West Inflow-Outflow Canal CNL-3.
- Construct citrus farm AGI-1 earthwork features (i.e., levee and borrow ditch).

Contract 5: Reservoir Dam Structures

- Construct Reservoir Perimeter Dam structures (OS-1, OS-2, CU-1A, and CU-2).
- Construct Divider Dam structure DDS-1.

Contract 6: Reservoir Perimeter Canal Structures and Other Water Management Structures

- Construct Reservoir Perimeter Canal CNL-1 structures (PCOS-2 through PCOS-4, PCCU-1 through PCCU-4, and PCW-1 through PCW-7).
- Construct Offsite Drainage Collection Canal Ditch Structure ODCD-OS-1.
- Construct CNL-3 ungated culvert CU-3
- Construct offsite outfall structures (OOS-1 through OOS-8).
- Construct citrus farm AGI structures (AGI-OS-1, AGI-PS-1 and AGI-PS-2).
- Demolish two citrus farm pump stations associated with existing AGI R12.

Contract 7: Reservoir Recreational Amenities

- Construct recreational amenities at the reservoir site.

A preliminary construction cost and schedule for each of these construction contracts is included in **Appendix B**.

A.3.3 Construction Sequencing and Staging

A.3.3.1 General

The Recommended Plan will involve several contractors working simultaneously to complete the work within the desired schedule. The specific sequencing of the components for each construction contract will be developed by the construction contractor using constraints that will be specified in the construction documents. The major constraints during construction of the Recommended Plan are described in the following paragraphs.

A.3.3.2 Access

The Project site is located in an agricultural area and access to the reservoir and S-83 sites will be from SR 70, the C-41A north levee road, as well as existing unpaved farm roads located within the boundary of the reservoir site. Access to the S-84 site will be from SR 70, Southwest Rucks Dairy Road, and the C-41A north levee road. SR 70 is a major traffic route and hurricane evacuation route. It is anticipated that this will be the primary access road to be used by the construction contractors during construction. It will be the responsibility of the contractors to coordinate with the Florida Department of Transportation (FDOT) regarding the maintenance of traffic along SR 70 during construction. After the Project is constructed, SR 70 and the C-41A north levee road will provide the main access to the Project features.

A.3.3.3 Reservoir, Roadway, and Canal Embankments

With exception of the clean sand, filter sand, and riprap that will be imported for the construction of the Project, most of the materials to be used in the construction of the embankments for the reservoir and its associated canals (CNL-1, CNL-2, and CNL-3) and roads will be excavated from the canals and borrow areas that are part of the Project.

A.3.3.4 Reservoir Pump Stations

The reservoir inflow pump station (PS-2) and the reservoir seepage pump station (SPS-1) will be located at the southeast side of the reservoir. It is expected that these pump stations will be constructed under a separate contract from reservoir embankment. Coordination between the two contracts will be necessary for the portion of the embankment where the pump stations will be constructed.

A.3.3.5 Structures that Connect Directly to C-41A

The ungated outflow culvert CU-3, the perimeter canal overflow structure PCOS-1, gated spillway S-84+, and pump station PS-1 will be connected directly to C-41A and will, therefore, each require dewatering and cofferdam construction to allow the structures to be constructed without taking C-41A out of service. Temporary access around new structure areas during their construction will be required to ensure that the construction of these structures does not interfere with any SFWMD operations and maintenance (O&M) activities along C-41A.

The following is a recommended sequence of construction for PS-1 and S-84+, so that C-41A can remain in service during the construction of these structures.

Recommended Sequence of Construction for PS-1 and S-84+

1. Install gravity bypass flow structure for S-84X, on the north side of S-84X.
2. Install cofferdams and dewatering system within C-41A on the upstream and downstream sides of S-84X.
3. Dewater within the cofferdams.
4. Demolish and remove S-84X.
5. Construct S-84+ at former location of S-84X.
6. Complete inspections, testing, and commission of S-84+.
7. Remove remaining portions of cofferdam and dewatering system.
8. Install cofferdams and dewatering system within C-41A on the upstream and downstream sides of S-84.
9. Dewater within the cofferdams.
10. Demolish and remove S-84.
11. Construct PS-1 at former location of S-84.
12. Complete inspections, testing, and commission of PS-1.
13. Remove remaining portions of cofferdam and dewatering system.

The Florida Fish and Wildlife Conservation Commission, Manatee Carcass Recovery Locations in Florida GIS dataset (available at <https://geodata.myfwc.com>) shows multiple manatee carcass recovery

locations within C-38, downstream of S-84/S-84X and S-65E/S-65EX1; therefore, PS-1 and S-84+ will be designed with appropriate permanent manatee protection measures. Also, during the demolition of S-84/S-84X and the construction of PS-1 and S-84+, appropriate temporary manatee protection measures will be provided within the C-41A canal right-of-way, in accordance with the environmental permitting requirements for this work and SFWMD standards, including but not necessarily limited to the following SFWMD standard specification sections:

- Section 01530 Temporary Barriers and Controls
- Section 01531 Manatee Protection
- Section 02435 Turbidity Control and Monitoring
- Section 02436 Environmental Protection

A.3.3.6 Agricultural Operations and Stormwater Management During Construction

Within the reservoir site, there are several major existing agricultural drainage ditches that convey stormwater through the reservoir site to existing project culverts (i.e. PC13N, PC15N, PC17N, PC18N, and PC20N) along the north side of C-41A, which discharge to C-41A. These ditches not only provide for drainage within the pastureland where the reservoir will be constructed, but they also convey stormwater discharges from the AGIs that serve the citrus fields north of the reservoir site (i.e. ODAs 8 through 14B) as well as convey stormwater from other offsite properties that discharge to the reservoir site (i.e. ODAs 1 through 7B).

It is anticipated that these ditches will need to remain in service during certain periods of time during the construction of the reservoir. As such, the proposed embankments that will cross these ditches will be constructed near the end of the construction period and coordinated with the construction of the reservoir perimeter canal and its overflow structures, to minimize construction delays due to flooded conditions caused by inadequate drainage along the perimeter of the reservoir site, as well as minimize drainage impacts to the upstream offsite AGIs and properties that historically drain to the ditches within the reservoir site (i.e. ODAs 1 through 14B). In addition, recognizing that most of the reservoir site is within Zone A of the FEMA 100-year floodplain (as shown on the Overall Site Plan with FEMA FIRM Floodplains in **Annex C-1**), it is likely that during each wet season the LOCAR contractors will at times experience flooded conditions within and around the reservoir site, caused by intense and/or prolonged rainfall, which may delay construction operations. Therefore, to reduce the likelihood during LOCAR construction of drainage impacts to offsite properties that historically drain to the reservoir site; and to reduce the likelihood of construction delays caused by flooded conditions within and around the reservoir site, it is critical that the LOCAR construction contractors for contracts 3, 4, 5, and 6 be required to submit a comprehensive Stormwater Management During Construction Plan to SFWMD for review and approval shortly after their notice to proceed with construction is issued by SFWMD. Also, these stormwater management plans must be approved by SFWMD before the LOCAR contractors begin any construction activities that may impact the drainage of the offsite AGIs or properties that historically drain to the reservoir site.

A Stormwater Pollution Prevention Plan (SWPPP), whether it is integrated into the Stormwater Management During Construction Plan or is a stand-alone document, will be required as a part of the contract documents for each of the major LOCAR construction contracts, described in **Section A.3.2**. The objective of the SWPPP will be to prevent erosion where construction activities are occurring, prevent

pollutants from mixing with stormwater, and prevent pollutants from being discharged by containing them on-site before they can affect the receiving waters. The contractors will be required to prepare and submit a comprehensive SWPPP that will be tailored to their sequence of construction. The contractors will be provided conceptual plans, guidelines, and criteria so that detailed drainage plans for all phases and sequences of construction can be prepared.

As part of the construction of the reservoir, the southernmost AGI within the Basinger Tract, R12, will be removed/demolished along with its two inflow pump stations and outfall structure. AGI R12 has an area of approximately 900 acres (ac) and is part of the permitted stormwater management system (SFWMD surface water management permit number 28-00146-S) that serves the citrus groves within the Basinger Tract, on the north side of the Project site. To ensure that this existing stormwater management system continues to function as permitted, it is proposed that a new AGI inflow pump station (AGI-PS-2) be constructed which will discharge to AGI R11; and a new AGI (AGI-1) be constructed, including an inflow pump station (AGI-PS-1) and outfall structure (AGI-OS-1), as shown on **Figure A.1-4**, to replace AGI R12 and its structures. During the PED phase of the Project, the design of these proposed modifications to the Basinger Tract stormwater management system will be finalized based on additional review and coordination with the Basinger Tract property owner.

A.3.3.7 Staging

There is ample space for multiple staging areas to be constructed within the portion of the Basinger Tract located along the north side of SR 70 and east of the reservoir site. This area is highlighted in blue and designated as the temporary construction office and staging area on **Figure A.1-1**. The number of staging areas will depend on the number of construction contracts for the Project. Locations and size of these staging areas will be established during the PED and construction phases. Contractors may establish minor staging areas along the perimeter of the reservoir, S-83, and S-84 sites to accommodate construction.

A.3.4 Demolition and Disposal

During the PED phase of the Project, a Phase I Environmental Site Assessment (and as needed a Phase II Environmental Site Assessment) will be completed for the LOCAR Project site. The demolition and disposal requirements for each LOCAR construction contract (including, but not limited to, the construction contracts in **Section A.3.2**) will be based on the findings of these Environmental Site Assessments.

The agricultural buildings and pump stations within the reservoir site will be removed by the contractor(s) for the embankment construction; and the materials will be disposed of by the contractor(s). The SFWMD may determine that certain mechanical equipment should not be demolished, but instead be preserved and transported to a location selected by SFWMD, as stated in the LOCAR construction contract documents. The reuse of any components of the existing AGI R12 pump stations for the construction of AGI-PS-1 and/or AGI-PS-2 will be coordinated during the PED phase with the landowner of the property where AGI-PS-1 and AGI-PS-2 are to be constructed.

Existing culverts, flashboard riser structures, and gravity water control structures located within the East Cell and West Cell of the reservoir site, outside of the limits of construction of the reservoir perimeter and divider dams, will not have a negative impact on the operation of the completed reservoir and therefore may remain.

A.3.5 Other Projects Affecting Construction

Currently, there are no projects known that are planned to be constructed in the immediate vicinity of the Project features that would impact their construction or operation.

A.4 General Design Requirements and Criteria

A.4.1 Project Limits and Site Datum

The reservoir site limits for the Recommended Plan, are generally bounded by the Basinger Tract property boundary to the east, C-41A to the south, the remainder of the Basinger Tract to the north, and the Basinger Tract property boundary to the west.

The horizontal datum used in **Appendix A** of this report is the North American Datum of 1983 (NAD83). Unless noted otherwise, the vertical datum used in **Appendix A** of this report is NAVD88. Some other reports and design documents referenced in this report or related to this project use the National Geodetic Vertical Datum of 1929 (NGVD29) as a vertical datum. The relationship between these datums is $NGVD29 = NAVD88 + 1.2 \text{ ft}$, for the geographic location of the proposed Project features at the reservoir site and at/near S-83 and S-84.

A.4.2 Survey and Geographic Information System (GIS) Data

The C-41A right-of-way (ROW) and spoil easement lines, and ROW lines of other canals shown on the **Annex C-1** site plans and sections, are based on ROW and easement boundaries obtained from georeferenced AutoCAD files associated with topographic survey drawings of C-41A obtained from SFWMD's Survey and Mapping Section for this study.

The Basinger Tract property boundaries and other property boundaries shown on the **Annex C-1** site plans are based on shapefiles of normalized parcels of the Project site from SFWMD's GIS database, obtained from SFWMD's Survey and Mapping Section for this study.

Reservoir earthwork quantities and stage-storage calculations, as well as hydrologic modeling for reservoir wind, wave, over wash, and dam breach analyses, and reservoir 3D seepage modeling are based on the "FL Peninsular FDEM Highlands 2018", 1 meter resolution, bare earth, LiDAR digital elevation map (DEM) dataset (downloaded from the USGS LiDAR Explorer Map website at: <https://apps.nationalmap.gov/lidar-explorer/#/>), which has a calculated root mean square error non-vegetated vertical accuracy of +/- 0.12 feet, according to the documentation for this LiDAR DEM dataset included in **Annex C-3**.

Additional LiDAR DEM datasets used for the LOCAR regional simulation modeling and dam breach modeling are described in **Annexes A-2.4 and A-2.7**, respectively.

A.4.3 Service Life

According to Corps publications EM 1110-2-3104 and EM 1110-2-3105, and SFWMD publication *Pump Station Engineering Guidelines* (January 2021 edition), the design life for each proposed pump station (i.e., PS-1, PS-2, and SPS-1) will be a minimum of 50 years. In addition, the design life for all other proposed structures that are part of the Recommended Plan will be a minimum of 50 years. With routine inspection and timely maintenance, a minimum service life of 50 years for the Project can be achieved by following the guidance in these documents and SFWMD's standard practices for inspection and maintenance of its water control structures.

The mechanical equipment will require rehabilitation or replacement over the design life. The electric motors and pumps will operate intermittently but will require regular maintenance. Generator engines

may require at least one major overhaul during the design life. The architectural and structural design of the pump stations and other structures will include elements that will require minimum maintenance and repair over the design life. During the PED phase, additional evaluations will be made concerning the potential need to increase the minimum-required design life beyond 50 years for components of each project feature. Consideration will be given for requiring a minimum design life of more than 50 years for components that remain submerged under normal project operations or otherwise not readily accessible for inspection and maintenance.

The design elements for the structural; civil; mechanical; electrical; instrumentation and control; architectural; plumbing; and heating, ventilation, and air conditioning (HVAC) are described in more detail in **Sections A.10** through **A.16**.

A.4.4 Units

The units and system of measurement will be in the English system of measurement.

A.4.5 Codes and Standards

Design and specification of all work shall be in accordance with latest laws and regulations of the federal government, with applicable local codes and ordinances, and with codes and industry standards referenced herein. **Sections A.4.4.1** through **A.4.4.12** below provide a listing of organizations with standards that are applicable to each major aspect of the Project design and construction. The design and construction of the Project will be based on the applicable standards of these organizations, including, but not limited to, the specific standards listed in **Sections A.4.4.1** through **A.4.4.12**. Recommended and recognized standards not listed in **Sections A.4.4.1** through **A.4.4.12** shall be used where required and approved to serve as guidelines for the design, fabrication, and construction when not in conflict with the standards referenced herein.

A.4.5.1 General

Standards listed under **Section A.4.4.1** include design criteria applicable to the design disciplines listed in **Sections A.4.4.2** through **A.4.4.11**.

- SFWMD and Corps CERP Guidance Memoranda
- SFWMD and Corps CERP *Standard Design Manual*, dated June 6, 2003
- SFWMD, Corps, and Florida Department of Environmental Protection (FDEP) CERP Design Criteria Memoranda (DCM). See **Section A.4.4.12** for additional information about CERP DCM.
 - Note, since PS-1 and PS-2 will each have a maximum pumping capacity of 1,500 cfs, these pump stations are classified as major pump stations under DCM-5; therefore, the design of these pump stations will need to be in accordance with the requirements of DCM-5 and the SFWMD Pump Station Engineering Guidelines (current version is the January 2021 edition), which includes the following disclaimer: *“Note that DCM-5 also provides guidelines for pump station design. This DCM has not been recently updated. If there are differences between the guidelines presented in that document (DCM-5) and the guidelines presented in this document, the guidelines presented in this document shall prevail unless otherwise directed by the SFWMD.”*
- SFWMD Design Standards and Guidelines

- USACE Engineering Manuals and Regulations

A.4.5.2 Site Work Design Criteria

- American Association of State Highway and Transportation Officials (AASHTO)
- American National Standards Institute, Inc. (ANSI)
- American Society for Testing and Materials (ASTM)
- Americans with Disabilities Act Accessibility Guidelines for Buildings and Facilities (ADAAG)
- Asphalt Institute (AI)
- Corps
- Federal Highway Administration (FHWA)
- FDOT
- Manual on Uniform Traffic Control Devices (MUTCD)
- SFWMD
 - *Pump Station Engineering Guidelines*, January 2021 edition
- Uniform Federal Accessibility Standards (UFAS)

A.4.5.3 Geotechnical Design Criteria

- ASTM
- Corps
 - EM 1110-2-1901, *Seepage Analysis and Control for Dams*, dated September 9, 1986
 - EM 1110-2-1902, *Engineering and Design: Slope Stability*, dated October 31, 2003
 - EM 1110-2-1913, *Design and Construction of Levees*, dated April 30, 2000
 - EM 1110-2-2300, *Earth and Rock-fill Dams, General Design, and Construction Considerations*, dated July 30, 2004
- Florida Building Code, 8th (2023) edition
- FDOT
- SFWMD
 - SFWMD Pump Station Engineering Guidelines, January 2021 edition
- SFWMD and Corps joint standards
 - *Hazard Potential Classification*, DCM-1, dated September 12, 2005
 - *Minimum Dimensions of Embankments (Levees and Dams), Ramps, Pull Outs, and Access Roads*, DCM-4, dated May 9, 2008
 - *Clarification of 2.2.3 Minimum Crest Width Requirements*, DCM-4 Clarification, dated February 27, 2009

A.4.5.4 Architectural Design Criteria

- Florida Accessibility Code, latest edition

- Florida Building Code, 8th (2023) edition
- Occupational Safety and Health Administration (OSHA), 29 Code of Federal Regulations (CFR)
- SFWMD *Pump Station Engineering Guidelines*, January 2021 edition

A.4.5.5 Structural Design Criteria

- AASHTO *LRFD Bridge Design Specifications*, 9th edition
- Aluminum Association, *Aluminum Design Manual*, 2020 edition
- American Concrete Institute (ACI)
 - ACI 318-19(22), *Building Code Requirements for Structural Concrete*
 - ACI 350-20/350R-20, *Code Requirements for Environmental Engineering Concrete Structures and Commentary*
 - ACI 350.4R-04, *Design Considerations for Environmental Engineering Concrete Structures*
- American Institute of Steel Construction, Inc. (AISC), *Steel Construction Manual*, 16th edition
- American Society of Civil Engineers Structural Engineering Institute, ASCE/SEI 7-22, *Minimum Design Loads and Associated Criteria for Buildings and Other Structures*
- American Welding Society (AWS)
 - AWS, *Structural Welding Code – Steel*, 24th edition
 - AWS, *Structural Welding Code – Stainless Steel*, 3rd edition
 - AWS, *Structural Welding Code – Aluminum*, 6th edition
- *Concrete Reinforcing Steel Institute Handbook*
- Corps
 - EM 1110-1-2009, *Architectural Concrete*, dated October 31, 1997
 - EM 1110-2-2000, *Standard Practice for Concrete for Civil Works Structures*, dated March 31, 2001
 - EM 1110-2-2102, *Waterstops and Other Preformed Joint Materials for Civil Works Structures*, dated September 30, 1995
 - EM 1110-2-2104, *Strength Design for Reinforced Concrete Hydraulic Structures*, dated November 30, 2016
 - EM 1110-2-2107, *Design of Hydraulic Steel Structures*, dated August 1, 2022
 - EM 1110-2-2502, *Floodwalls and Other Hydraulic Retaining Walls*, dated August 1, 2022
 - EM 1110-2-3104, *Structural and Architectural Design of Pumping Stations*, dated June 30, 1989
- Florida Building Code, 8th (2023) edition
- Precast/Prestressed Concrete Institute *PCI Design Handbook, Precast and Prestressed Concrete*
- SFWMD *Pump Station Engineering Guidelines*, January 2021 edition

A.4.5.6 Special Mechanical Equipment Design Criteria

- AASHTO
- American Bearing Manufacturers Association (ABMA)
- American Gear Manufacturers Association (AGMA)
- American Petroleum Institute (API)
 - API Standard 620, *Design and Construction of Large Low Pressure Storage Tanks*
 - API Standard 650, *Welded Steel Tanks for Oil Storage*
- ASME/ANSI
 - ASME/ANSI B1.20.1, *General Purpose Pipe Threads*
 - ASME/ANSI B16.1, *Cast Iron Pipe Flanges and Flanged Fittings, Class 25, 125, 250, and 800*
 - ASME/ANSI B16.5, *Steel Pipe Flanges and Flanged Fittings*
 - ASME/ANSI B16.11, *Forged Fittings, Socket-welding and Threaded*
 - ASME/ANSI B16.21, *Nonmetallic Flat Gaskets for Pipe Flanges*
 - ASME/ANSI B16.25, *Butt-welding Ends*
 - ASME/ANSI B31.10, *Pressure Piping*
- ASTM
 - ASTM A36, *Structural Steel*
 - ASTM A53, *Pipe, Steel, Black and Hot-dipped, Zinc-coated Welded and Seamless*
 - ASTM A105, *Forgings, Carbon Steel for Piping Components*
 - ASTM A139, *Electric Fusion Welded Steel Pipe*
 - ASTM A139B, *Specification for Electric-fusion (Arc)-welded Steel Pipe*
 - ASTM A181, *Forgings, Carbon Steel for General Purpose Piping*
 - ASTM A283, *Carbon Steel Plate, Shapes, or Bars*
 - ASTM A307, *Specification for Carbon Steel Bolts and Studs, 60,000 psi Tensile*
 - ASTM A312, *Specification for Seamless and Welded Austenitic Stainless Steel Pipe*
 - ASTM A563, *Specifications for Carbon and Alloy Steel Nuts*
 - ASTM A568, *Steel, Sheet, Carbon, and High Strength, Low Alloy Hot Rolled and Cold Rolled*
 - ASTM A570, *Hot Rolled Carbon Steel Sheet*
 - ASTM F593, *Stainless Steel Bolts, Hex Nuts, Screws, and Studs, 2000*
- American Water Works Association (AWWA)
 - AWWA C200, *Steel Water Pipe 6 Inches and Larger*
 - AWWA C207, *Steel Pipe Flanges for Waterworks Service, Sizes 4 Inch through 144 Inch*
 - AWWA C208, *Dimensions for Fabricated Steel Water Pipe Fittings*
 - AWWA M11, *Steel Water Pipe-A Guide for Design and Installation*

- AWWA C600, *Installation of Ductile-iron Water Mains and Their Appurtenances*
- ANSI/ASME B36.10, *Welded and Seamless Wrought Steel Pipe*
- Corps
 - EM 1110-2-3104, *Structural and Architectural Design of Pumping Stations*, dated June 30, 1989
 - EM 1110-2-3105, *Mechanical and Electrical Design of Pumping Stations*, dated April 30, 2020
- U.S. Environmental Protection Agency (EPA) Regulation 40 CFR Part 280.41
- Heat Exchange Institute (HEI)
- Hydraulic Institute Standards (HI)
 - ANSI/HI 9.6.1-2017, *American National Standard for Rotodynamic Pumps—Guideline for NPSH Margin*
 - ANSI/HI 9.8-2018, *American National Standard for Rotodynamic Pumps for Pump Intake Design*
 - ANSI/HI 14.3-2019, *American National Standard for Rotodynamic Pumps for Design and Application*
- Manufacturers Standardization Society of Valve and Fitting Industry (MSS)
 - ANSI/MSS SP-58-2018, *Pipe Hangers and Supports, Materials, Design, Manufacture, Selection, Application, and Installation*
- National Fire Protection Association (NFPA)
 - NFPA 30, *Flammable and Combustible Liquids Code*
 - NFPA 30A, *Code for Motor Fuel Dispensing Facilities and Repair Garages*
 - NFPA 37, *Standard for the Installation and Use of Stationary Combustion Engines and Gas Turbines*
 - NFPA 307, *Standard for the Construction and Fire Protection of Marine Terminals, Piers, and Wharves*
 - NFPA 329, *Recommended Practice for Handling Releases of Flammable and Combustible Liquids and Gases*
- Pipe Fabrication Institute (PFI)
 - PFI-ES5, *Cleaning of Fabricated Pipe*
- Steel Structures Painting Council (SSPC)
 - SSPC SP1, *Solvent Cleaning*
 - SSPC SP3, *Power Tool Cleaning*
 - SSPC SP5, *White Metal Blast Cleaning*
 - SSPC-SP6, *Commercial Blast Cleaning*
 - SSPC SP7, *Brush Off Blast Cleaning*
- SFWMD *Pump Station Engineering Guidelines*, January 2021 edition

- Underwriters Laboratories (UL)
 - UL-142, *Steel Aboveground Tanks for Flammable and Combustible Liquids*

A.4.5.7 HVAC, Plumbing, and Fire Suppression

- American Society of Heating, Refrigeration, and Air Conditioning Engineers (ASHRAE) *Handbooks and Standards*
- American Society of Plumbing Engineers (ASPE) *Handbooks*
- Florida Building Code, 8th (2023) edition—*Mechanical*
- Florida Building Code, 8th (2023) edition—*Plumbing*
- Florida Fire Protection Code, latest edition
- SFWMD *Pump Station Engineering Guidelines*, January 2021 edition
- NFPA *Recommended Practices and Manuals*
- OSHA *Standards Manual*
- Sheet Metal and Air Conditioning Contractor National Association (SMACNA) *Handbooks*

A.4.5.8 Fire Protection and Detection Design Criteria

- International Code Council, 2018 *International Building Code*
- International Code Council, 2021 *International Fire Code*
- NFPA
- OSHA
- SFWMD *Pump Station Engineering Guidelines*, January 2021 edition
- UL

A.4.5.9 Electrical Design Criteria

- ANSI
 - ANSI C2-2023, *National Electrical Safety Code*
 - ANSI C84.1-2020, *Electric Power Systems and Equipment-Voltage Ratings (60 Hertz)*
 - ANSI A117.1, *Buildings and Facilities-Providing Accessibility and Usability for Physically Handicapped People*
 - ANSI/Institute of Electrical and Electronics Engineers (IEEE) Standard. 242, *Recommended Practice for Protection and Coordination of Industrial and Commercial Power Systems (The Buff book)*
- Corps *Technical Standards*, TI-800-01
- IEEE C62.41, *Surge Voltage in Low Voltage AC Power Circuits*
- Illuminating Engineering Society (IES) *Lighting Handbook, Reference Volume and Application Volume*
- NFPA

- NFPA 70, *National Electrical Code*
- NFPA 72, *National Fire Alarm Code*
- NFPA 101, *Code for Safety to Life from Fire in Buildings and Structures*
- NFPA 78, *Lightning Protection Code*
- SFWMD *Pump Station Engineering Guidelines*, January 2021 edition
- UFAS
- UL 268, *Smoke Detectors for Fire Protective Signaling Systems*

A.4.5.10 Instrumentation and Controls Design Criteria

- ANSI
 - ANSI C37.90-2005, *Relays and Relay Systems Associated with Electric Power Apparatus*
 - ANSI C37.90.1-2012, *Surge Withstand Capability (SWC) Test for Protective Relays and Relay Systems*
 - EM ANSI/EIA/TIA-232-F (2002), *Interface Between Data Terminal Equipment and Data Circuit-Terminating Equipment Employing Serial Binary Data Interchange*
- IEEE
 - IEEE C62.41 (1991), *Recommended Practice for Surge Voltages in Low-voltage AC Power Circuits*
 - IEEE Standard 100 (2000), *IEEE Standard Dictionary of Electrical and Electronics Terms*
 - IEEE Standard 802 (1990; R 1995), *Information Processing Systems, Local Area Networks: Part 4: Token Passing Bus Access Method and Physical Layer Specifications*
- International Electrotechnical Commission (IEC) 61131-3 (2003), *Programmable Controllers—Part 3: Programming Languages*
- National Electrical Manufacturer’s Association (NEMA)
 - ANSI/NEMA 250-2020, *Enclosures for Electrical Equipment (1,000 Volts Maximum)*
 - NEMA ICS 1-2022, *Industrial Control and Systems General Requirements*
 - NEMA ICS 2-2000, *Industrial Control and Systems Controllers, Contactors, and Overload Relays Rated 600 Volts*
 - NEMA ICS 4-2015, *Application Guideline for Terminal Blocks*
 - NEMA ICS 6-1993 (R2016), *Industrial Control and Systems: Enclosures*
- NFPA 70, *National Electrical Code*
- SFWMD *Pump Station Engineering Guidelines*, January 2021 edition
- UL
 - UL 1059 (July 28, 2022), *Standard for Safety Terminal Blocks*
 - UL 508 (July 8, 2021), *Standard for Safety Industrial Control Equipment*

A.4.5.11 Telemetry System Design Criteria

- Electronics Industries Alliance (EIA)
 - EIA ANSI/TIA/EIA-222-F (1996), *Structural Standards for Steel Antenna Towers and Antenna Supporting Structures*
 - EIA ANSI/EIA/TIA-232-F (2002), *Interface between Data Terminal Equipment and Data Circuit Terminating Equipment Employing Serial Binary Data Interchange*
 - EIA ANSI/EIA-310-D (1992), *Racks, Panels, and Associated Equipment*
- Federal Communications Commission (FCC), 47 CFR 15, *Radio Frequency Devices*
- SFWMD
 - *Design Standards and Guidelines*
 - *Pump Station Engineering Guidelines*, January 2021 edition

A.4.5.12 CERP Design Criteria Memoranda

Latest version of each CERP DCM, including any revisions or clarifications issued, is listed below in **Table A.4-1**.

Table A.4-1. Summary of CERP Design Criteria Memoranda.

DCM No.	DCM Title or Clarification Description	Effective Date
DCM-1	Hazard Potential Classification	September 12, 2005
DCM-2	Wind and Precipitation Design Criteria for Freeboard	February 6, 2006
DCM-3, Revision 1.0	Spillway Capacity and Reservoir Drawdown Criteria	February 3, 2006
DCM-4, Revision 1.0	Minimum Dimensions of Dams and Embankments	May 9, 2008
DCM-4, Clarification 1.0	Clarification of 2.2.3 Minimum Crest Width Requirements	February 27, 2009
DCM-4, Clarification 2.0	Clarification of Section 2.2.2 Constructability and 2.4 Interior Dikes/Breakwaters	April 25, 2011
*DCM-5	Pump Station Engineering Guidelines	January 2021
DCM-6	Geotechnical Seismic Evaluation of CERP Dam Foundations	May 16, 2005
DCM-7, Revision 1.0	Procedure for Development of Engineering Const. Costs	June 15, 2015
DCM-8	Vulnerability Protection Requirements	N/A (Never Issued)
DCM-9	Dam Safety Instrumentation and Monitoring	June 15, 2007
DCM-10	Construction Quality Assurance Procedures	N/A (Never Issued)
DCM-11	Dam Safety Program	June 18, 2007
DCM-12	Value Engineering	N/A (Never Issued)

DCM—Design Criteria Memorandum

*See SFWMD *Pump Station Engineering Guidelines – Fifth Edition*, dated January 2021, which is referenced in DCM-5.

A.5 Hydrology

A.5.1 Hazard Classification and Emergency Evacuation Requirements

The reservoir, as designed according to the Recommended Plan, is classified as a high hazard potential impoundment (i.e., major impoundment), as specified in the Federal Emergency Management Agency's Selecting and Accommodating Inflow Design Floods for Dams (FEMA 2013) and Design Criteria Memorandum: DCM-1, Hazard Potential Classification (DCM-1) (Arnold et al. 2005) guidelines. Preliminary dam breach modeling of this reservoir design, performed for LOCAR in accordance with DCM-1, indicate that County Road (CR) 721, State Route (SR) 70, and the farmland surrounding the Project site will likely be significantly impacted in the event of a breach of the reservoir's perimeter dam, which will lead to life threatening conditions for nearby farm personnel and motorists along CR 721 and SR 70, as well as impede emergency evacuation routes along CR 721, SR 70, and other roads within Highlands County and Glades County. See **Section A.19** for a discussion regarding dam safety considerations and the Emergency Action Plan (EAP) to be developed for the reservoir.

A.5.2 Design Storms and Floods

A.5.2.1 Design Case 1: 100-year Wind with Probable Maximum Precipitation

Design Case 1, as documented in the routing analysis included in **Annex A-2.1**, assumes an event that includes a series of three major storm events, including a storm with the Probable Maximum Precipitation (PMP) and a 100-year Average Recurrence Interval (ARI) wind acting on the reservoir during the peak water level in the reservoirs. The maximum still water elevation for the reservoir (also referred to as the maximum water storage level [MWSL]) was determined based on a routing analysis, referred to as DCM-2 PMP Scenario 1 in **Annex A-2.1**, that included the following conditions:

- Maximum discharge from the reservoir into the C-41A Canal during the simulation is 1,500 cfs.
- Routing starts when the reservoir is at the Normal Full Storage Level (NFSL) of 51.7 feet NAVD88.
- Initially, 30 percent of the 72-hour PMP (16.18 inches) falls during the first storm event of the simulation (simulation time 0 to 72 hours). During this period, the reservoir's two gated outflow structures (CU-2 and CU-1A) are closed; and the only outflow from the reservoir occurs through its two ungated overflow spillways (OS-1 and OS-2), at a rate less than 1,500 cfs.
- Next, a 3-day dry interval occurs (simulation time 72 to 144 hours). During this period, the reservoir's two gated outflow structures open and discharge together with the two ungated overflow spillways at a combined constant rate of 1,500 cfs.
- Next, 100 percent of the 72-hour PMP (53.94 inches) falls during the second storm event of the simulation (simulation time 144 to 216 hours). During this period, the reservoir's two gated outflow structures are closed, and the only outflow from the reservoir occurs through its two ungated overflow spillways, at a rate less than 1,500 cfs.
- Next, a 10-day dry interval occurs (simulation time 216 to 456 hours). During this period, the reservoir's two gated outflow structures open and discharge together with the two ungated overflow spillways at a combined constant rate of 1,500 cfs.

- Finally, 30 percent of the 72-hour PMP (16.18 inches) falls during the third storm event of the simulation (simulation time 456 to 528 hours). During this period, the reservoir's two gated outflow structures are closed and the only outflow from the reservoir occurs through its two ungated overflow spillways at a rate less than 1,500 cfs.

A combined rainfall hyetograph and reservoir discharge hydrograph of this routing analysis (DCM-2 PMP Scenario 1) is provided in Figure 3 of **Annex A-2.1**.

The procedure described in Design Criteria Memorandum: DCM-2, Wind and Precipitation Design Criteria for Freeboard (DCM-2) (Haapala et al. 2006) was followed to provide an estimate of the 100-year ARI wind speed magnitude for the LOCAR. As specified in DCM-2, the 50-year three second wind gust for the LOCAR site is 112 miles per hour (mph), which converts to approximately 120 mph for a 100-year three second wind gust. This matches the latest ASCE/SEI 7-22 (American Society of Civil Engineers 2022) 100-year wind gust estimates for the region.

The 100-year gust wind speed was converted to a 100-year 1-hour overwater wind speed of approximately 95.3 mph. After adjustments for duration and overwater conditions, the sustained wind speed magnitude was estimated to be 94.9 mph for the East Cell, and 95.3 mph for the West Cell.

A.5.2.2 Design Case 2: Category Five Hurricane with 100-year Storm

Design Case 2 represents a 100-year precipitation event in combination with a Category 5 wind speed as defined by the Saffir-Simpson Hurricane Scale.

A 100-year precipitation event of 10.9 inches has been adopted for this design case which is based the NOAA Atlas 14 rainfall estimate for the site location. This is slightly lower than the 100-year precipitation event rainfall of 12 inches from Figure DCM 2-3 of DCM-2 (Haapala et al. 2006). The NOAA Atlas 14 rainfall depth was selected because it is based on more recent historical rainfall data than the DCM-2 rainfall depth. It is anticipated that NOAA Atlas 15 rainfall depths for the continental United States, will be published sometime in 2026. If NOAA Atlas 15 rainfall depths are available for use early enough during the PED phase of the Project, they should be compared with the NOAA Atlas 14 rainfall depths; and a determination should be made on which rainfall depths to use for the finalization of the Project design during the PED phase.

As recommended in DCM-2, a one-minute overwater wind speed of 156 mph was used to represent a Category 5 hurricane. After adjustments for duration to achieve fully developed wave conditions over the reservoir cell fetch lengths, the sustained wind speed magnitude was estimated to be 125.1 mph for the East Cell and 125.2 mph for the West Cell.

A.5.2.3 Design Case 3: Probable Maximum Wind (200 mph)

Design Case 3 represents the Probable Maximum Wind (PMW) speed in combination with the reservoir level at the normal full storage depth (i.e., approximately 17.6 ft for the LOCAR). As recommended in DCM-2, this particular design case was used for sensitivity testing only and not as a selected design condition (Haapala et al. 2006):

[The probable maximum wind...] is to be used for "sensitivity identification" and not as a design condition. Wave models are unlikely capable of yielding results within a degree of confidence for design for these

extreme wind speeds, especially over relatively shallow water bodies. Even for 125-mph wind, model capabilities are most likely being “stretched” for project conditions.

As defined in DCM-2, a one-minute averaged overwater wind speed of 200 mph was used to represent the PMW. The one-minute average wind speed was converted to an hourly averaged wind speed of 161 mph. After adjustments for duration, the sustained wind speed magnitude was estimated to be 161.3 mph for the East Cell and 161.5 mph for the West Cell.

A.5.2.4 Design Case 4: Storm-specific Wind and Precipitation

Design Case 4 represents a storm specific case of precipitation and wind conditions recorded during Hurricane Easy which occurred in Florida in 1950.

Precipitation depths for both the 24-hour and 72-hour rainfall durations are considered in this analysis, corresponding to 38.7 inches and 45.2 inches respectively (Haapala et al. 2006).

A maximum wind speed of 125 mph (3 second gust) was recorded during Hurricane Easy (Haapala et al. 2006). After adjustments to meet DCM-2 requirements (i.e. overwater conditions, wind duration for wave development etc.) the sustained wind speed magnitude was estimated to be 99.1 mph for the East Cell and 99.4 mph for the West Cell.

A.5.2.5 Summary

Table A.5-1 summarizes the wind and precipitation design conditions that were used to determine the appropriate embankment height for the reservoir.

Table A.5-1. Wind and Precipitation Design Conditions.

Design Case	Description	Wind East Cell (mph)	Wind West Cell (mph)	Precipitation (inches)	East Cell Average Water Depth ^{1/} (ft)	West Cell Average Water Depth ^{1/} (ft)
1	100 yr ARI wind + PMP ^{2/}	94.9	95.3	86.32	22.3	22.6
2	Cat 5 Hurricane + 100yr ARI Precipitation	125.1	125.2	10.9	18.6	18.9
3	Probable Max Wind Speed (Sensitivity Testing Only)	161.3	161.5	0	17.7	18.0
4.1	Storm Specific Wind & 24hr Precipitation (Hurricane Easy)	99.1	99.4	38.7	20.9	21.2
4.2	Storm Specific Wind & 72hr Precipitation (Hurricane Easy)	99.1	99.4	45.2	21.5	21.8

1/ Average water depth = [NFSL (51.7 ft NAVD88) – Average Ground Elevation (34 ft NAVD88 East Cell; 33.7 ft NAVD88 West Cell)] + Precipitation; with the exception of Design Case 1 where the Average water depth = PMF water level for Design (56.3 ft NAVD88) – Average Ground Elevation (34 ft NAVD88 East Cell; 33.7 ft NAVD88 West Cell)]

2/ The probable maximum precipitation equals 53.94 inches. The precipitation for Design Case 1 is based on the occurrence of three consecutive storms, with the first and third, each bringing 30% of the PMP and the second bringing the full PMP.

A.5.3 Reservoir Inflows and Outflows

The proposed LOCAR Alternative 1 has a normal full storage level of 51.7 feet-NAVD, which corresponds to an average normal full storage depth of 17.8 feet, since the average bottom elevation of the reservoir is 33.9 feet-NAVD.

A.5.3.1 Inflow Design Storm

The inflow design storm (IDF) for the proposed reservoir is the probable maximum flood (PMF) as designated by DCM-2. Because the Reservoir functions as an off-line reservoir and has no contributing watershed except for its surface area, the PMF is the PMP precipitation depth of 53.94 inches (approximately 4.5 feet) distributed appropriately in time. **Annex A-2.1** contains a technical memorandum that describes the development of the PMP precipitation depth for the reservoir site. To determine the total inflow, the PMP precipitation depth is multiplied by the area of the reservoir cells at the normal full storage level. The area of the reservoir's east and west storage cells (within the centerline of their perimeter and divider dams) is approximately 10.22 mi² (6,541 ac) and 7.47 mi² (4,779 ac), respectively. The total inflow to the LOCAR from the 72-hour PMP precipitation was calculated as approximately 50,430 acre-ft.

A.5.3.2 Routing of Flood Flows

Because the proposed reservoir has a perimeter dam embankment and has no contributing watershed except for the surface area of the reservoir, there are no direct overland runoff gravity inflows to the reservoir during storm events; and the only gravity inflow during storms will be from precipitation falling directly over the reservoir area. During storm events, the reservoir will be capable of releasing water to the C-41A canal via two gated outflow culverts (one per cell) and two overflow spillways (one per cell). See **Section A.6** for discussion regarding the reservoir uncontrolled spillway structures and gated outflow culverts. **Annex A-2.1** contains a technical memorandum that documents the PMF routing that was conducted in accordance with DCM-2, in order to determine the size and flow capacity of the overflow spillway for each cell, as well as determine the reservoir's maximum water storage level (MWSL) simulated by PMF routing of Scenarios 1 and 2, to use for the Design Case 1 wind and wave analysis described in **Section A.5.2.1**. The PMF routing showed that PMF Scenario 1 resulted in the MWSL for the reservoir of 56.3 feet-NAVD, with a combined peak discharge rate of 1,496 cfs from the two overflow spillways, each with a crest width of 29.1 feet, which is within the allowable peak discharge rate of 1,500 cfs, determined for the reservoir as discussed in **Section A.5.3.3**.

In addition, the PMF routing model was used to check the peak discharge rate from the reservoir for the 10-year, 72-hour and 100-year, 72-hour design storms, for the scenario when the reservoir is filled to its NFSL at the start of the storm and the only stormwater discharged from the reservoir during the simulation is through its two overflow spillways (OS-1 and OS-2). **Table A.5-2** shows that the combined peak discharge rate from the reservoir through its two overflow spillways for each design storm, is lower than the allowable peak discharge rate to C-41A of 35.4 cubic feet per second per square mile (CSM) for the 10-year design storm, as stated in Appendix A of Volume II of the SFWMD Environmental Resource Permit Applicant's Handbook.

Table A.5-2. 10-year and 100-year Design Storm Routing Results.

Reservoir Overflow Spillway ^{1/}	Simulated Peak Discharge ^{2/}			
	100-Yr, 72-Hr Design Storm ^{3/} (Total Rainfall = 10.9 inches)		10-Yr, 72-Hr Design Storm ^{3/} (Total Rainfall = 7.0 inches)	
	cfs	CSM ⁴	cfs	CSM ⁴
East Cell Overflow Spillway (OS-1)	63.8	6.3	33.0	3.2
West Cell Overflow Spillway (OS-2)	63.8	8.7	33.0	4.5

Total	127.6	7.3	66.0	3.8
-------	-------	-----	------	-----

1/ Crest width for each overflow spillway in the routing simulations is 29.1 feet.

2/ No gated culvert discharge occurred during the routing simulations. For the routing simulations, the starting stage in each cell was set at the reservoir NFSL of 51.7 ft-NAVD.

3/ Total rainfall for each design storm obtained from NOAA Atlas 14. See statements about NOAA Atlas 15 in Section A.5.2.2.

4/ Contributing area in routing simulations is 10.16 square miles for the east cell and 7.37 square miles for the west cell.

A.5.3.3 Reservoir Releases and Discharges

Environmental Releases

Environmental releases from the reservoir will primarily be based on expected environmental deliveries for the reservoir to Lake Okeechobee, as well as deliveries to C-41A, C-41, C-39A, and C-40 needed to maintain optimum stages within these canals, as described in **Annex C**. Discharge structures include gates sized according to the flows established based on releases from the reservoir per the SFWMD Regional Simulation Model runs for LOCAR, in conjunction with communication with Water Managers. **Section A.6** provides details of flows considered for sizing all water control structures. Gate discharges will follow orifice flow principles and gate openings will be a function of meeting the required releases from the reservoir. See **Section A.6** for discussion regarding the reservoir gate structures.

Stormwater Discharges Resulting from Rainfall on the Reservoir Storage Cells

Part 4 of Design Criteria Memorandum: DCM-3, Spillway Capacity and Reservoir Drawdown Criteria (DCM-3) (Arnold et al. 2006), states the following concerning discharges from CERP reservoirs:

“The location and size of the spillways on the dam must consider the flood carrying capacity of the downstream conveyance system. Downstream flooding impacts from reservoir spillway discharges must be considered.”

“The receiving canals/river channel capacity must be considered and if feasible should be co-located with larger receiving channels when siting of the spillway(s). In some cases, consideration should be given to increasing capacity of receiving channels in conjunction with construction of new spillways.”

Considering these requirements from DCM-3, the allowable peak discharge rate from the reservoir via its gated outflow culverts and ungated overflow spillways to C-41A was determined to be 1,500 cfs for the PMP event (54 inches of rainfall over the reservoir in 72 hours) and storm events with lesser precipitation than the PMP event, with the provision that gated spillways S-84 and S-84X, which have a combined design flow capacity of 6,670 cfs (5,670 cfs S-84 capacity [30 percent SPF peak discharge rate to C-41A] + 1,000 cfs S-84X capacity), would be replaced with gated spillway S-84+, which will have a design flow capacity of 9,000 cfs (100 percent SPF peak discharge rate to C-41A).

Since C-41A would convey stormwater discharges from the reservoir and continue to convey stormwater discharges from the C-41AN and C-41AS watersheds; plus convey the portion of the 3,000 cfs firm capacity released from S-68 that flows through S-83 (calculated to be 2,091 cfs, given the design flow capacities of S-82 and S-83), it was calculated that of the 9,000 cfs of proposed capacity for S-84+, that the reservoir could contribute up to 1,500 cfs, based on its contributing area of 11,340 ac (area within its perimeter dam that drains to its gated outflow culverts and ungated overflow spillways) and the total contributing area of 51,822 ac of watersheds C-41AN and C-41AS that drain to S-84/S-84X. This equates to a discharge rate from the reservoir of 84.4 cfs per square mile (CSM) to S-84+. The reservoir’s allowable peak discharge

rate to S-84+ via C-41A is expressed by the following formula. The formula is based on starting with the proposed design capacity of S-84+ and subtracting the estimated S-68 firm capacity flow through S-83; and then allocating a portion of the remaining S-84+ design capacity to the reservoir based on the reservoir's percentage of contributing area that it occupies within the total contributing area of the watersheds that drain to S-84+ via C-41A.

LOCAR Allowable Peak Discharge Rate = (Proposed S-84+ Design Capacity – Estimated S-68 Firm Capacity Flow through S-83) x (LOCAR contributing area for S-84+ / Total contributing for S-84+)

LOCAR Allowable Peak Discharge Rate = (9,000 cfs – 2,091 cfs) x (11,340 ac / 51,822 ac) = 1,516 cfs or 85.3 CSM
Use 1,500 cfs or 84.4 CSM for the LOCAR allowable peak discharge rate.

A.5.4 Wave and Overtopping Analysis—Traditional Method

Wave overtopping is an important parameter in determining appropriate freeboard levels for reservoirs. The volume of water that may flow over the crest of the structure during storm events is dependent on hydrodynamic parameters (i.e., wave height and period, angle of wave attack, and water depth), as well as the characteristics of the embankment (e.g., crest height, roughness, and slope). Therefore, as part of the FS for LOCAR, a wave and overtopping analysis was undertaken to:

1. Estimate the maximum wave conditions generated across LOCAR during extreme design wind events through wave transformation modeling (STWAVE); and
2. Assess the embankment crest elevation based on the predicted volume of overtopping for the design wave conditions using empirical methods (EurOtop).

The above analysis methods are traditionally adopted for assessing wave conditions and overtopping volumes for Comprehensive Everglades Restoration Plan (CERP) reservoirs. Alternative analysis methods (i.e., Computational Fluid Dynamics) have also been investigated for the reservoir (refer to **Section A.5.5**).

The following section describes the outcomes of the wave and overtopping analysis based on the traditional method. Full details of the wave and overtopping assessment are provided in **Annex A-2.2**.

A.5.4.1 Embankment Characteristics

Figure A.5-1 illustrates the cross-sectional design of the reservoir perimeter dam embankment that was used for the overtopping analysis. A slope of 1:3 (vertical to horizontal) is proposed for inner and outer side slopes of the embankment, with a 16-inch-thick layer of soil cement revetment to be applied along the inner side slope and crest, and a 6-inch-thick layer of topsoil to be sodded on the outer side slope.

The NFSL of the reservoir is at an elevation of 51.7 ft NAVD88. A borrow area up to 4-ft-deep and typically 1,500 to 1,600-ft-wide is located inside the perimeter of both the East and West Cells.

A.5.4.2 Wind Setup

Wind setup is caused by shear stress exerted on the water surface, which in turn causes a slope in the water surface that results in wind setup at the leeward side of the reservoir. This setup level influences the water depth at the reservoir embankment and, therefore, the wave run-up/overtopping discharge. Hence, the calculation of wind setup is required for determination of freeboard (Haapala et al. 2006).

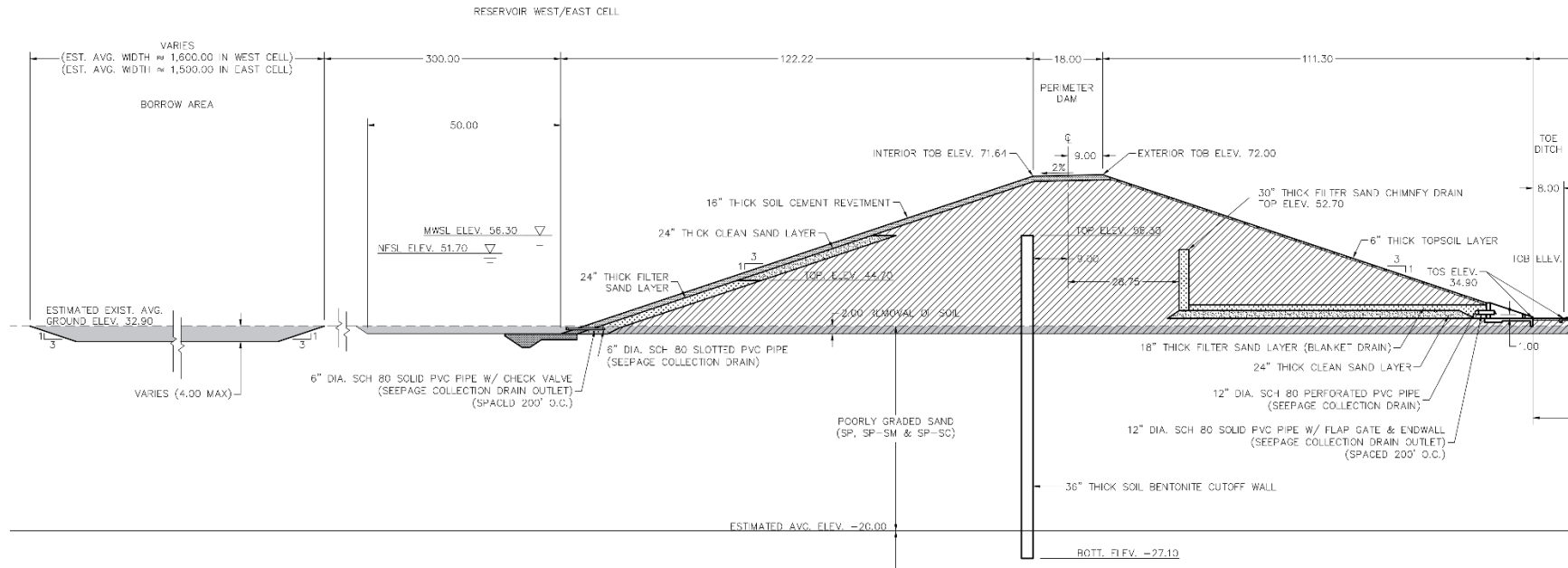

Figure A.5-1. Typical cross-section for the LOCAR embankment.

For reservoirs with depths equal to or greater than 16 ft, DCM-2 recommends that wind setup is calculated using the Zeider Zee equation, which calculates wind setup based on wind speed, fetch length, and depth. **Table A.5-3** and **Table A.5-4** summarize the estimated wind setup for each of the DCM-2 design cases for the East and West Cells respectively, as well as the resulting maximum water depth and elevation at the leeward side of the reservoir.

Table A.5-3. Summary of Calculated Wind Setup–East Cell.

Design Case	Wind (mph)	Effective Water Depth ^{1/} (ft)	Maximum wind setup (ft) ^{2/}	Maximum water depth ^{3/} (ft)	Maximum Water Elevation ^{4/} (ft NAVD88)	Freeboard to TOB water side ^{5/} (ft)
1	94.9	22.3	1.3	23.6	57.6	14.0
2	125.1	18.6	2.6	21.2	55.2	16.4
3 (Sensitivity Testing)	161.3	17.7	4.5	22.2	56.2	15.4
4.1	99.1	20.9	1.5	22.4	56.4	15.2
4.2	99.1	21.5	1.4	22.9	56.9	14.7

1/ Water level elevation = Normal Full Storage Level (51.7 feet [ft]) + Precipitation; with the exception of the Probable Maximum Flood (PMF) water level (56.3 ft North Atlantic Vertical Datum of 1988 [NAVD88]), which is based on results from the Probable Maximum Precipitation (PMP) Routing Assessment

2/ Maximum wind setup calculated based on maximum fetch length of 4.4 miles as described in **Annex A-2.2**.

3/ Maximum water depth = Effective water depth + Wind setup

4/ Maximum water elevation based on assumed average ground level of 34 ft NAVD88 for the East Cell

5/ Freeboard to Top of Bank (TOB) water side = TOB water side elevation (71.64 ft NAVD88) – Maximum water elevation

Table A.5-4. Summary of Calculated Wind Setup–West Cell.

Design Case	Wind (mph)	Effective Water Depth ^{1/} (ft)	Maximum wind setup (ft) ^{2/}	Maximum water depth ^{3/} (ft)	Maximum Water Elevation ^{4/} (ft NAVD88)	Freeboard to TOB water side ^{5/} (ft)
1	95.3	22.6	1.1	23.7	57.4	14.3
2	125.2	18.9	2.2	21.1	54.8	16.8
3 (Sensitivity Testing)	161.5	18.0	3.8	21.8	55.5	16.1
4.1	99.4	21.2	1.2	22.4	56.1	15.5
4.2	99.4	21.8	1.2	23.0	56.7	14.9

1/ Water level elevation = Normal Full Storage Level (51.7 feet [ft]) + Precipitation; with the exception of the Probable Maximum Flood (PMF) water level (56.3 ft North Atlantic Vertical Datum of 1988 [NAVD88]), which is based on results from the Probable Maximum Precipitation (PMP) Routing Assessment

2/ Maximum wind setup calculated based on maximum fetch length of 3.67 miles as described in **Annex A-2.2**.

3/ Maximum water depth = Effective water depth + Wind setup

4/ Maximum water elevation based on assumed average ground level of 33.7 ft NAVD88 for the West Cell

5/ Freeboard to Top of Bank (TOB) water side = TOB water side elevation (71.64 ft NAVD88) – Maximum water elevation

A.5.4.3 Wave Modeling

Wave transformation A.5-8 modelling was undertaken using STWAVE to estimate wave growth within LOCAR for the wind and precipitation design cases described in **Section A.5.2**.

Spatially constant wind speeds with overwater and duration adjustments were applied within the model based on the slightly higher wind speeds estimated for the West Cell. Multiple wind directions were tested

in the model (at 22.5-degree [°] increments), as well as a wind direction aligned with the longest fetch length (i.e., wind coming from approximately 333.5° True North). The maximum water elevation applied as input into the model included wind setup, and was based on the slightly higher estimates for the East Cell (refer to **Table A.5-3**). This is a conservative approach, as wind setup is applied to the whole reservoir; however, in reality, setdown would decrease water depths at the upstream end and hence could reduce wave growth slightly.

The maximum design wave conditions generated at the perimeter of the eastern and western cells are summarized below in **Table A.5-5**. Maximum wave heights for the design conditions range from 8.1 ft to 10.3 ft in the East Cell, with peak wave periods from 5.0 seconds (s) to 5.6 s (generated from wind coming from approximately 333.5° True North). Maximum wave conditions in the West Cell range from 7.6 ft to 9.7 ft, with peak wave periods from 4.5 s to 5.6 s (generated from a northwesterly wind).

Full details of the wave assessment, including the wave directionality assessment and model validation, are provided in **Annex A-2.2**.

Table A.5-5. LOCAR Wave Prediction Results.

Design Case	Wind (mph)	East Cell		West Cell	
		Significant Wave Height, Hmo (ft)	Peak Wave Period, Tp (s)	Significant Wave Height, Hmo (ft)	Peak Wave Period, Tp (s)
1	95.3	8.1	5.0	7.6	4.5
2	125.2	10.3	5.6	9.7	5.6
3 (Sensitivity Testing)	161.5	12.4	6.2	11.4	6.2
4.1	99.4	8.3	5.0	7.8	5.0
4.2	99.4	8.4	5.0	7.8	5.0

A.5.4.4 Overtopping Analysis

An overtopping analysis was undertaken to determine the minimum embankment level required to limit overtopping to acceptable volumes during the design cases specified in **Section A.5.2**. The design wave and water level conditions adopted for the overtopping analysis are summarized below in **Table A.5-6** and **Table A.5-7** for the East and West Cell, respectively.

Table A.5-6. Design Conditions Adopted for the Overtopping Analysis–East Cell.

Design Case	Maximum water depth ^{1/} (ft)	Maximum Water Level Elevation ^{2/} (ft NAVD88)	Significant Wave Height, Hmo (ft)	Peak Wave Period, Tp (s)
1	23.6	57.6	8.1	5.0
2	21.2	55.2	10.3	5.6
3 (Sensitivity Testing)	22.2	56.2	12.4	6.2
4.1	22.4	56.4	8.3	5.0
4.2	22.9	56.9	8.4	5.0

1/ Maximum water depth = Average water depth + Wind setup

2/ Maximum water level elevation = Normal Full Storage Level (51.7 feet [ft]) + Precipitation + Wind setup; with the exception of Design Case 1 where Maximum water level = Probable Maximum Flood (PMF) water level from the Probable Maximum Precipitation (PMP) Routing Assessment (56.3 ft North Atlantic Vertical Datum of 1988) + Wind setup

Table A.5-7. Design Conditions Adopted for the Overtopping Analysis–West Cell.

Design Case	Maximum water depth ^{1/} (ft)	Maximum Water Level Elevation ^{2/} (ft NAVD88)	Significant Wave Height, Hmo (ft)	Peak Wave Period, Tp (s)
1	23.7	57.4	7.6	4.5
2	21.1	54.8	9.7	5.6
3 (Sensitivity Testing)	21.8	55.5	11.4	6.2
4.1	22.4	56.1	7.8	5.0
4.2	23.0	56.7	7.8	5.0

1/ Maximum water depth = Average water depth + Wind setup

2/ Maximum water level elevation = Normal Full Storage Level (51.7 feet {ft}) + Precipitation + Wind setup; with the exception of Design Case 1 where Maximum water level = Probable Maximum Flood (PMF) water level from the Probable Maximum Precipitation (PMP) Routing Assessment (56.3 ft North Atlantic Vertical Datum of 1988) + Wind setup

The overtopping assessment was undertaken based on the analysis techniques described in the EurOtop Manual (2018). The equations used for the analysis were based on those specified for a “deterministic design or safety assessment” approach, which include a partial safety factor of one standard deviation (EurOtop, 2018).

For the purposes of this FS, acceptable overtopping limits were defined in terms of the mean overtopping discharge. A mean overtopping discharge limit of 0.05 cfs per lineal foot of embankment was adopted for the assessment, as described in the technical memorandum included in **Annex A-2.5**. In addition to the mean overtopping discharge rate, the maximum overtopping volume of a single wave was also estimated.

Mean Overtopping Discharge

Overtopping discharges were calculated for varying embankment levels. The results indicate that an exterior top-of-bank elevation of 72 ft NAVD88 is required to meet the overtopping limit of 0.05 cfs/ft based on the East Cell (which is the critical design case).

Results from this assessment are summarized in **Table A.5-8**. As per recommendations is DCM-2, Design Case 3 is used for sensitivity testing only and not as a selected design condition.

Table A.5-8. Calculated mean overtopping discharge.

Exterior Top of Bank Elevation (ft NAVD88)	Design Case	Freeboard (Rc) to Exterior Top of Bank ¹ (ft)		Mean Overtopping Discharge (cfs/ft)	
		East Cell	West Cell	East Cell	West Cell
71.5	1	13.90	14.10	0.021	0.004
	2	16.25	16.72	0.059	0.037
	3 (Sensitivity Testing)	15.26	16.00	0.360	0.212
	4.1	15.10	15.35	0.012	0.008
	4.2	14.59	14.81	0.018	0.011
72	1	14.40	14.60	0.016	0.003
	2	16.75	17.22	0.048	0.030
	3 (Sensitivity Testing)	15.76	16.50	0.309	0.180
	4.1	15.60	15.85	0.009	0.006
	4.2	15.09	15.31	0.014	0.008

72.5	1	14.90	15.10	0.012	0.002
	2	17.25	17.72	0.039	0.024
	3 (Sensitivity Testing)	16.26	17.00	0.264	0.152
	4.1	16.10	16.35	0.007	0.004
	4.2	15.59	15.81	0.011	0.006

1/ Freeboard to exterior top of bank = Exterior top of bank elevation – Maximum water level elevation

Maximum Overtopping Volume

The maximum overtopping volume of a single wave was calculated based on an exterior top-of-bank level of 72 ft NAVD88. **Table A.5-9** summarizes the results for this analysis based on the East Cell (most conservative scenario), including the percentage of overtopping waves, which is a function of the 2 percent wave run-up height (EurOtop 2018). A maximum overtopping volume of 19.2 ft³/ft for a single wave is estimated for the proposed embankment level. This is below the limit recommended by the EurOtop Manual (i.e. 22 – 32 ft³/ft) for grass-covered dikes with maintained and closed grass cover, and hence is deemed acceptable. A conservative storm duration of 3 hours was adopted for this assessment (refer to **Annex A-2.2** for additional details).

Table A.5-9. Summary of Overtopping Probability and Maximum Overtopping Volume for a Single Wave (Assuming 3-hour Storm Duration).

Design Case	Freeboard to Exterior Top of Bank (ft)	2% Wave Run-up (ft)	Probability of Overtopping	Maximum Overtopping Volume for a Single Wave (ft ³ /ft)
1	14.40	17.1	6.2%	8.2
2	16.75	21.6	9.4%	19.2
3 (Sensitivity Testing)	15.76	26.2	24.2%	60.2
4.1	15.60	17.3	4.1%	6.4
4.2	15.09	17.5	5.4%	7.8

A.5.4.5 Findings and Recommendations

A wave and overtopping analysis was undertaken to support the preliminary design of LOCAR Alternative 1. STWAVE modeling was undertaken to estimate wave conditions generated within LOCAR for the wind and precipitation design cases specified by DCM-2. Design wave heights predicted for the East Cell of the reservoir ranged from 8.1 ft to 10.3 ft, with peak periods ranging from 5.0 s to 5.6 s. Design wave heights for the West Cell ranged from 7.6 ft to 9.7 ft, with peak periods ranging from 4.5 s to 5.6 s.

An overtopping analysis was undertaken to determine a suitable embankment crest configuration to limit overtopping of LOCAR to acceptable volumes during wave and wind-setup levels generated from the DCM-2 design cases. A range of analysis techniques, as described in the EurOtop Manual (2018), were used to estimate overtopping characteristics for the proposed 1:3 embankment slope. The results from the analysis indicate that an 18 ft embankment crest width with an exterior top-of-bank level of 72 ft NAVD88 will achieve acceptable overtopping rates below 0.05 cfs/ft.

During the PED phase, alternative design refinements to manage wave overtopping at the reservoir could be evaluated and may include, but not be limited to the following:

- Inclusion of an intermediate berm;

- Increasing the roughness of the slope and/or crest by (e.g., quarry stones, concrete blocks) to reduce wave run-up; and/or
- Armoring or vegetating the outer (i.e., landward side) slope of the embankment to provide increased protection against overtopping.

In addition, after the layout of the reservoir is finalized during the PED phase, it is recommended that the spatial variability in the wave overtopping along the embankment is further investigated and the design refined accordingly. Such a design refinement may include but not limited to having a variable crest elevation along the reservoir perimeter and divider dams.

During the 5-day Risk Assessment Workshop for the LOCAR FS, hosted by the Corps from August 28th to September 1, 2023, the Corps risk cadre recommended that consideration be given to lowering the proposed crest elevation of the reservoir divider dam, as a cost savings measure. It is recommended that this proposed cost savings measure be investigated during the PED phase of the project. If during the PED phase, it is determined that the divider dam crest should be lowered, it is recommended that in order to reduce the potential that the divider dam structure DDS-1 may not be accessible during an extreme storm event, and to protect its control building from wave damage, that the crest elevation along the portion of the divider dam crest that extends from the southern perimeter dam to DDS-1, not be lowered to the same degree as the divider dam crest along the segment that extends from the north side of DDS-1 to the north perimeter dam.

As shown in the cross-sections included in **Annex C-1**, structures CU-1A, CU-2, OS-1, OS-2, PS-2, SPS-1, and DDS-1 include components that penetrate the reservoir perimeter/divider dam; as a result, under certain conditions, components of these structures would be exposed to wave and flood forces from waves and floods generated within the reservoir. During the PED phase, load cases involving potential wave and flood loads (including overtopping loads) on these structures will be analyzed to finalize the design of these structures. Structural design of structures subject to flood loads will be determined consistent with ASCE/SEI 7-22, Section 5.4. For structures in which analytical methods from ASCE/SEI 7-22, Section 5.4.4 are used for estimating breaking wave loads, a dynamic pressure coefficient of 3.5 will be used (see **Section A.10.3.8**).

A.5.5 Wave and Overtopping Analysis – Alternate Approach

An alternative approach for estimating wave overtopping and addressing freeboard requirements for the design storm scenarios described in **Section A.5.2** is documented in **Annex A-2.3**. The alternate approach involves:

- Modeling the transition of overland winds defined for Design Cases 1 and 4 (a and b) to overwater wind speeds using Computational Fluid Dynamics (CFD). It is noted that DCM-2 specifies the magnitude of overwater winds to use Design Cases 2 and 3 and, therefore, adjustments of wind speeds to account for this transition were not required.
- Modeling wave growth within the reservoir using a numerical model with a cap on the drag coefficient, “Cd,” used by the model to determine the momentum transfer between the wind and water.
- Modeling wind setup using a two-dimensional (2D) numerical model to model the hydrodynamic response of the reservoir to the design winds.

- Modeling wave overtopping using a CFD model.

The alternative approach was performed to address uncertainties associated with the more traditional method, including the transition from overland to overwater winds over the elevated reservoir's water surface; the effect of decreased shear stress between the wind and water surface during extreme wind speeds on the wave growth in the reservoir; and overtopping during extreme wave conditions for the embankment crest geometry, which originally included a wave wall. The CFD model developed for evaluating wave overtopping was also planned to be used for generating loads for preliminary design of the wave wall. This analysis was performed for the East Cell of the reservoir only with winds coming from 330° True North, the approximate direction of the longest wind fetch in the reservoir.

In the end, Design Case 2, which directly specifies overwater wind speeds and did not utilize the wind model to model the transition from land to the reservoir's water surface, drove the design of the embankment. Additionally, the wave wall was removed from the embankment design due primarily to its potential for wildlife entrapment and the CFD model for both overtopping and wave loading was not used in the final analysis. The TM documenting the alternative approach has been kept in this final FS report for record purposes in **Annex A-2.3** and as a reference in the event it is decided to include a wave wall in the project design during the PED phase of the project.

A.5.6 Reservoir Seiche Analysis

Development of significant seiche waves as a response to seismic activity that could overtop a dam would likely need to be accompanied by either a large landslide, or coseismic movement of the reservoir basin due to vertical fault displacement within the reservoir or tilting of the reservoir basin (BOR, 2015). Neither of these should be expected at the LOCAR reservoir site.

BOR (2015) indicates that, although uncommon, seiches on the order of 1 foot high or greater can be induced in reservoirs due to earthquake vibrations alone. These could result from earthquakes centered far from the reservoir.

FERC (2018) notes that in 1891, an earthquake near Port Angeles, Washington, caused an eight-foot seiche in Lake Washington, however it is unclear if the cause of this was due directly to ground motion, or other causes such as a landslide. Other literature documents heights of seiches resulting from seismic activity.

Vorhis (1967) documents measured seiches in water bodies across the United States and across the world in response to the March 27, 1964 Alaska earthquake. The maximum double amplitude deviation in water surface measured in water bodies within Alaska following the earthquake was 1.53 feet. The maximum seiche recorded in a lake or reservoir in the entire United States resulting from the 1964 Alaska earthquake had a double amplitude of 1.83 feet, recorded in a small (7 million gallon) reservoir in Michigan. These are consistent with order of magnitude of seiches noted in BODR (2015).

The potential for a seiche to be excited in a reservoir by ground motions depends on the natural period of oscillation of the water in the reservoir compared with the period of the ground motions resulting from the earthquake.

The fundamental natural free oscillating period of a closed rectangular basin can be written as:

$$T_n = \frac{2l_B}{\sqrt{gh}}$$

Where:

T_n = fundamental free oscillating period

l_b = the length of the basin

g = the acceleration of gravity

h = the water depth

Using approximate dimensions, based on a length of 23,000 feet, a width of 14,000 feet, and an average water depth of 18 feet at NFSL, the fundamental longitudinal and transverse periods of oscillation for the LOCAR East Cell are about 32- and 19-minutes, respectively. Based on the dimensions of the West Cell, which also has an average water depth of approximately 18 feet at NFSL, the fundamental periods of oscillation for it would also fall within this range. Although ground movement from a seismic event could cause movement of water in the reservoir, it is unlikely that sufficient ground movement would occur with a period near the 19- to 32-minute natural period to produce a significant seiche.

If a seiche occurred, the amplitude of the seiche would likely be on the order of 1 foot or less. Given that the freeboard above the NFSL is over 14 feet, it is concluded that any seiche produced by seismic activity would not overtop the reservoir.

A.5.7 References

- Arnold, T., J. Haapala, S. Partney, Y. Shen., B. Trauger, and R. Tucker. 2005. Design Criteria Memorandum: DCM-1, Hazard Potential Classification. 12 September 2005.
- Arnold, T., J. Haapala, P. Linton, and Y. Shen. 2006. Design Criteria Memorandum: DCM-3, Spillway Capacity and Reservoir Drawdown Criteria. 3 February 2006.
- American Society of Civil Engineers Structural Engineering Institute, ASCE/SEI 7-22, Minimum Design Loads and Associated Criteria for Buildings and Other Structures.
- BOR, 2015. Design Standards No. 13 – Embankment Dams. Chapter 13: Seismic Analysis and Design. DS-13(13)-8: Phase 4: Final. US Department of the Interior, Bureau of Reclamation. May 2015.
- Corps (U.S. Army Corps of Engineers). 2008. Coastal Engineering Manual. Chapter 2, Meteorology and Wave Climate. EM 1110-2-1100 (Part II) (Change 2). United States Army Corps of Engineers. 1 August 2008.
- EurOtop. 2018. *Manual on Wave Overtopping of Sea Defenses and Related Structures: An Overtopping Manual Largely Based on European Research, but for Worldwide Application*. 2nd Edition. Edited by J.W. Van der Meer, N.W.H. Allsop, T. Bruce, J. De Rouck, A. Kortenhaus, T. Pullen, H. Schüttrumpf, P. Troch, B. and Zanuttigh. Available online at: <https://www.overtopping-manual.com>.
- FEMA (Federal Emergency Management Agency). 2013. Selecting and Accommodating Inflow Design Floods for Dams. FEMA P-94. August.
- FERC, 2018. Engineering Guidelines for the Evaluation of Hydropower Projects. Chapter 13 – Evaluation of Earthquake Ground Motions. Federal Energy Regulatory Commission. May 30, 2018.
- Haapala, J., T. Arnold, S. Partney, R. Tucker, L. Hadley, S. Smith, and Y. Shen. 2006. Design Criteria Memorandum: DCM-2, Wind and Precipitation Design Criteria for Freeboard. 6 February 2006.

USACE, 2008. Coastal Engineering Manual. Chapter 5, Water Levels and Long Waves. EM 1110-2-1100 (Part II), August 1, 2008.

Vorhis, 1967. Hydrologic Effects of the Earthquake of March 27, 1964 Outside of Alaska. Geological Survey Professional Paper 544-C. United States Department of the Interior. 1967.

A.6 Hydraulic Design

A.6.1 Introduction

The major features of the Recommended Plan are shown in **Figure A.1-2**. These features will be operated in conjunction with the local existing C&SF Project features, labeled in **Figure A.1-1**, for the purpose of filling and emptying the storage reservoir. A comprehensive summary table and detailed map of the Recommended Plan project features are provided in **Table A-1.1** and **Figure A.1-4**. The hydrologic and hydraulic (H&H) calculations and modeling that support the hydraulic design of the Project features presented in **Section A.6**, are provided in **Annex A-1.1** Hydraulic Modeling and Calculations and **Annex A-2.6** Reservoir Perimeter Canal System Modeling Technical Memorandum.

To ensure that the Recommended Plan will not interrupt the existing drainage pattern of the offsite drainage basins/properties that historically drain to the reservoir site (ODAs 1 through 14B identified on **Figure A.1-4**), nor increase peak flood stages within these basins/properties, the Project includes a perimeter canal (CNL-1) around the reservoir designed to simultaneously convey peak seepage flows from reservoir (intercepted by the perimeter canal as described in **Section A.9**) and peak stormwater discharges from the reservoir site and adjacent offsite basins (that historically drain to the reservoir site) to C-41A. The 1D HEC-RAS-HMS H&H models presented in **Annex A-2.6** were used to determine the effectiveness of the perimeter canal to meet this design intent.

In accordance with Section 3.11 of Guidance Memorandum (GM) #3, from the CERP Programmatic Regulations, Six Program-Wide Guidance Memoranda (Corps and SFWMD 2007), during the PED phase of the Project, these 1D HEC-RAS-HMS H&H models presented in **Annex A-2.6**, will be converted to and/or replaced with 2D HEC-RAS-HMS H&H models (or other 2D H&H models approved by the Corps and District to use for the Project); and these 2D H&H models will be used to run continuous simulations for a climatic period of record, in order to address the Flood Protection Savings Clause requirements of GM #3. In addition, these 2D models will be used to run simulations that account for the effects of anticipated climate change (e.g. increases in precipitation depths of standard design storms as discussed in **Section A.5.2.2 and Annex H**). During the PED phase, a technical memorandum that summarizes this 2D H&H modeling, along with the 2D modeling files, will be submitted to the Corps, Jacksonville District for review and approval prior to finalizing the engineering design of the Project during the PED phase. Revisions to the 2D model and technical memorandum as well as revisions to the engineering design of the Project will be completed during the PED phase to address as needed any review comments from the Jacksonville District, concerning this 2D H&H modeling.

During the PED phase of the Project, the location and design of each Recommended Plan feature will be refined and optimized, which may include adjustments to the layout of the reservoir, as well as the relocation, addition, removal, and/or combination of some water control structures and conveyance features. It is recommended that during the PED phase, computational fluid dynamics (CFD) modeling be performed for all proposed canals as well as proposed intake/discharge channels for water management structures, to not only finalize the geometric design of these canals/channels, but to also finalize the design (i.e. the extent, thickness and type) of the riprap and/or other channel linings required to provide scour protection for these canals, channels and structures.

A.6.2 General Reservoir Design Guidelines

The design criteria defined for the reservoir and its water control structures was determined in consultation with SFWMD staff and is based on results obtained from SFWMD's Regional Simulation Model (described in SFWMD's model documentation report in **Annex A-2.4**), and SFWMD's design standards (i.e., standard guideline drawings, standard details and design criteria memoranda (DCM)). The SFMWD Regional Simulation Model simulates in a regional setting the inflows to, outflows from, and operations of the reservoir for a 52-year period (1965 – 2016) of climatological inputs (rainfall and evapotranspiration). Releases from the reservoir will meet Lake Okeechobee stage regulation needs, and supplemental irrigation needs for the Indian Prairie Sub-basin, described further in SFWMD's model documentation report in **Annex A-2.4**. The DCM-3 guidelines for spillway capacity and reservoir drawdown criteria states that a spillway is required for high hazard potential impoundments and project works must be designed to either withstand overtopping for the loading condition that would occur during a flood or to the point where a failure would no longer cause an unacceptable additional downstream threat up to the PMF resulting from the PMP event. The total rainfall depth during the PMP event predicted for the reservoir is 54 inches (4.5 ft) as discussed in **Section A.5**.

The reservoir design assumes that the inflow pumps will be off when the reservoir level reaches the normal full storage level (NFSL) at elevation 51.70 ft NAVD88, which is the maximum elevation of storage where drawdown outflow from the reservoir would begin. Average ground elevation along the perimeter dam of the reservoir is around 32.90 ft NAVD88. DCM-3 reservoir drawdown requirements are based on Corps Engineering Regulation (ER) 1110-2-50, Low Level Discharge Facilities for Drawdown of Impoundments. At a minimum, low level discharge facilities will be sized to be capable of reducing the normal full storage to a pool level which will result in an amount of storage in the reservoir that is 10 percent of the NFSL, within a period of four months. The beginning pool level for drawdown will be the NFSL. As discussed in **Section A.5**, the reservoir's two ungated overflow spillways (OS-1 and OS-2), and gated outflow culverts (CU-1A and CU-2A) have been sized to limit the total peak discharge rate from the reservoir during the Scenario 1 and 2 PMF events to 1,500 cfs.

A.6.3 Gravity Conveyance Structures

A.6.3.1 Ungated Overflow Spillways OS-1 and OS-2

The reservoir design includes two uncontrolled overflow spillways, OS-1 in the East Cell, and OS-2 in the West Cell, with fixed crests to relieve high flood conditions. Both spillways are located on the southern boundary of the reservoir and will discharge directly to the C-41A canal downstream of S-83. The following were the established design criteria for the overflow spillways:

1. The crest elevation of the spillways is at the NSFL of 51.7 ft NAVD88.
2. The allowable combined peak discharge from OS-1 and OS-2 for Scenarios 1 and 2 of the simulated PMF is 1,500 cfs.

The widths of OS-1 and OS-2 were determined based on an iterative process to maximize discharge, while remaining under the allowable combined peak discharge (1,500 cfs) to the C-41A canal as described in the PMP-PMF technical memorandum presented in **Annex A-2.1**. The resulting maximum width for both spillways is 29.1 ft. OS-1 and OS-2 are represented in the proposed condition HEC-RAS model of the Perimeter Canal (CNL-1) system described in **Annex-2.6**.

A.6.3.2 Gated Outflow Culvert (CU-1A)

Structure CU-1A is a two-barreled gated box culvert which will allow for controlled flow from the reservoir East Cell into the reservoir Perimeter Canal (CNL-1). The proposed location of the structure is on the south side of the East Cell east of the PS-2 pump station.

The design criteria established for structure CU-1A are the following:

- A minimum flow capacity of 1,500 cfs from the reservoir East Cell to the reservoir Perimeter Canal with 1 ft head differential.

The CU-1A structure is composed of two 14-ft-wide by 10-ft-tall box culverts with gates. Low headwater level in the East Cell is estimated to be elevation 33.5 ft based on the average ground elevation of around 32 ft NAVD88 with an average of about 1 ft of water depth remaining in the cell. Tailwater level for the structure is estimated to range between 24.0 and 27.0 ft NAVD88, which is zero to 3 ft above the control elevation of Reach 7 of the Perimeter Canal. Average ground elevation at the structure location is about 27 ft NAVD88. CU-1A includes an energy dissipation structure at its downstream end, and the portion Perimeter Canal it discharges to will be lined with riprap.

A.6.3.3 Outflow Weir and Culvert (CU-1B)

Structure CU-1B is a two-barreled box culvert and adjustable weir structure which will allow for controlled flow from the reservoir Perimeter Canal into the reservoir Inflow-Outflow Canal. The proposed location of the structure is on the south side of Reach 7 of the Perimeter Canal near the south side of the East Cell, east of the PS-2 pump station.

The design criteria established for structure CU-1B are the following:

- A minimum flow capacity of 1,500 cfs from the reservoir Perimeter Canal to the reservoir Inflow-Outflow Canal with 1 ft head differential.

The CU-1B structure is comprised of two 14-ft-wide by 10-ft-tall box culverts with an adjustable weir structure at their upstream end. The crest of the adjustable weir will normally be set at its highest elevation of 26.0 ft NAVD88; however, when water is released from the reservoir via CU-1A, the crest of the adjustable weir will be lowered to its lowest level of 24.0 ft NAVD88. CU-1B's lowest possible weir crest setting corresponds to the control elevation of Reach 7 of CNL-1, which is 24.0 ft NAVD88. This will help to prevent any sudden lowering of the stage in Reach 7 below its control elevation of 24.0 ft NAVD88, which is a necessary safeguard for the stability of the reservoir perimeter dam adjacent to Reach 7. CU-1B's normal weir crest setting of 26.0 ft NAVD88 (when there is no flow out of CU-1A) is set above the fixed crest elevation of 25.5 ft NAVD88 of the perimeter canal overflow structures in Reach 7 (i.e. PCOS-1 through PCOS-4, and ODCD-OS-1), so that during most storm events, stormwater discharges from Reach 7 will be through the perimeter canal overflow structures and not through CU-1B. This will help to minimize the potential collection of debris in CU-1B, which should help to minimize required maintenance for this adjustable weir structure. Low headwater level for CU-1B in the Perimeter Canal is estimated to be elevation 24.0 ft NAVD88, which is the control elevation of Reach 7 of the Perimeter Canal (CNL-1), where CU-1B is located. Tailwater level for the structure is estimated to range between 23.1 and 24.0 ft NAVD88, which is the normal operating range of the C-41A Canal between S-83 and S-84. Average ground elevation at the structure location is about 27 ft NAVD88. CU-1B does not include an energy dissipation structure at its downstream end; however, the reservoir Inflow-Outflow Canal that it discharges to will be

lined with riprap. CU-1B with its weir crest elevation set to 26.0 ft NAVD88 is represented in the proposed condition HEC-RAS model of the Perimeter Canal (CNL-1) system described in **Annex-2.6**.

A.6.3.4 Gated Outflow Culvert (CU-2)

Structure CU-2 is a two-barreled gated box culvert which will allow for controlled flow from the reservoir West Cell into the reservoir Outflow Canal. The proposed location of the structure is near the southwest corner of the West Cell.

The design criteria established for structure CU-2 are the following:

- A minimum flow capacity of 1,500 cfs from the reservoir West Cell to the reservoir Outflow Canal with 1 ft head differential.

The CU-2 structure is composed of two 14-ft-wide by 10-ft-tall box culverts with gates. Low headwater level in the West Cell is estimated to be elevation 33.5 ft NAVD88 based on the average ground elevation of around 32 ft NAVD88 with an average of about 1 ft of water depth remaining in the cell. Tailwater level for the structure is estimated to range between 30.6 and 31.0 ft NAVD88, which is the normal operating range of the C-41A Canal between S-68 and S-83. Average ground elevation at the structure location is about 29 ft NAVD88. CU-2 does not include an energy dissipation structure at its downstream end; however, the east end of the reservoir Outflow Canal that it discharges to will be lined with riprap.

A.6.3.5 Ungated Outflow Culvert (CU-3)

CU-3 is an open culvert connecting the CNL-3 canal to the C-41A canal west of the S-83 structure.

The design criteria established for structure CU-3 are the following:

1. A minimum flow capacity of 1,500 cfs from CNL-3 to the C-41A canal with a 1.0 ft head differential.

Two box culverts 10-ft-wide by 12-ft-tall, with an invert elevation of 8.8 ft NAVD88 to match the C-41A canal bottom elevation.

A.6.3.6 Divider Dam Structure (DDS-1)

DDS-1 is a gated control structure connecting the East Cell to the West Cell.

The design criteria established for structure CU-1 are the following:

1. A minimum flow capacity of 1,500 cfs from East Cell to the West Cell with a 0.5 feet head differential.

DDS-1 is a two-gate structure, each gate is 22-ft-wide by 10-ft-tall. The structure will have a flat bottom at elevation 26 ft NAVD88.

DDS-1 was included in the proposed condition HEC-RAS model of the Perimeter Canal (CNL-1) system described in **Annex-2.6**.

A.6.3.7 Perimeter Canal Ungated Culverts (PCCU-1 to PCCU-4)

These are culverts in the Perimeter Canal (CNL-1). Each culvert will be sized to pass peak simultaneous seepage and design storm flows in CNL-1. These structures are represented in the proposed condition HEC-RAS model of the Perimeter Canal (CNL-1) system described in **Annex-2.6**.

A.6.3.8 Perimeter Canal Adjustable Weirs (PCW-1 to PCW-10)

PCW-1 through 10 are a series of weirs in CNL-1 to control seepage water levels around the perimeter of the reservoir. Topography around the reservoir slopes to the south and requires these weirs to maintain water levels consistent with the changes in topography and groundwater levels along the CNL-1. The crest elevation for each weir will be adjusted within allowable limits (to be determined during the PED phase), to control the water level within each of the ten reaches of CNL-1, as needed during annual wet and dry seasons. The preliminary typical wet and dry season control elevations for each reach of CNL-1 area discussed in **Section A.9** and shown on the overall site plan in **Annex C-1**. The preliminary typical control elevations between adjacent reaches varies between 0.5 feet and 7.4 feet. During the PED phase of the Project, when the number and limits, as well as the minimum, maximum, and typical control elevations of each reach of the reservoir perimeter canal are finalized, the perimeter canal adjustable weirs will need to be designed to resist sliding and overturning due to the maximum anticipated head differential across each weir, which will also include the design of seepage control features (e.g. sheet piling, seepage collection/drainage system, riprap revetment, etc.) for each weir to ensure the stability of the soil around each weir against erosive surface flow and seepage flow. The perimeter canal weir structures proposed in the Recommended Plan (PCW-1 through 10) are represented in the proposed condition HEC-RAS model of the Perimeter Canal (CNL-1) system described in **Annex A-2.6**.

A.6.3.9 Perimeter Canal Overflow Structures (PCOS-1 to PCOS-4) and ODCD-OS-1

Reach 7 of the Perimeter Canal (CNL-1) includes four gravity overflow weir and culvert structures, PCOS-1 through 4, which will discharge directly to C-41A or indirectly to C-41A via an existing downstream ditch and project culvert along the northeast side of C-41A. Each of these perimeter canal overflow structures will include a single or multi-barrel culvert with a fixed weir at its upstream end. The preliminary crest elevation for each fixed weir is 25.5 ft NAVD88, which may be revised during the PED phase of the Project. PCOS-1 through 4 are represented in the proposed condition HEC-RAS modeling of the Perimeter Canal (CNL-1) system described in **Annex A-2.6**.

Offsite Drainage Collection Ditch No. 1 (ODCD-1) will have an open connection to Reach 7 of CNL-1 via the culverts PCCU-2 and PCCU-4. ODCD-1 includes gravity overflow weir and culvert structures, ODCD-OS-1, which will discharge to C-41A via existing project culvert PC15N. ODCD-OS-1 will include a single or multi-barrel culvert with a fixed weir at its upstream end. The preliminary crest elevation of the fixed weir is 25.5 ft NAVD88, which may be revised during the PED phase of the Project. ODCD-OS-1 is represented in the proposed condition HEC-RAS model of the Perimeter Canal (CNL-1) system described in **Annex A-2.6**.

A.6.4 Pump Stations

A.6.4.1 Pump Station (PS-1)

PS-1 moves water from the C-41A Canal on the east side of S-84+ to the C-41A Canal on the west side of S-84+.

The design criteria established for structure include:

1. A minimum flow capacity of 1,500 cfs, using four-375 cfs pumps.
2. Each pump would be driven by an electric motor.
3. Trash screens would be installed to protect the pumps.

Operating conditions for the pump stations are based on historic stages in the C-38 and C-41A. PS-1 would be combined with the replacement of the S-84 spillway structure, which will be a new spillway named S-84+ in this report. The S-84+ would be reconfigured to have three-22-ft-wide gates.

Additional information about PS-1 is provided in **Section A.12**.

A.6.4.2 Pump Station (PS-2)

PS-2 moves water from the C-41A canal to the East Cell of LOCAR.

The design criteria established for structure include:

1. A minimum flow capacity of 1,500 cfs, using four-375 cfs pumps.
2. Each pump would be driven by an electric motor.
3. Trash screens would be installed to protect the pumps.

The pump station would draw water from C-41A canal via the inflow\outflow canal CNL-2.

Additional information about PS-2 is provided in **Section A.12**.

A.6.4.3 Seepage Pump Station (SPS-1)

SPS-1 moves seepage water from the reservoir that collects in the Reservoir Perimeter Canal (CNL-1) to the East Cell of reservoir.

The design criteria established for structure include:

1. A maximum flow capacity of 100 cfs, using two-50 cfs main pumps, with a third 50 cfs auxiliary pump. This arrangement of the pumps is in accordance with the three-pump configuration described in Section 3.2.3 of the SFWMD Pump Station Engineering Guidelines (January 2021 edition). The planning level 3D seepage modeling for the project described in **Section A.9** shows that, under the wet and dry season simulations when the reservoir is at its NFSL of 51.7 ft NAVD88, that the Perimeter Canal (CNL-1) will collect seepage from the reservoir at a rate of 14.7 cfs and 12.8 cfs, respectively. For the purposes of this planning study, the proposed maximum flow capacity for SPS-1 was conservatively set at 100 cfs. It is expected that during the PED phase, as recommended in **Section A.9.4**, a calibrated 3D seepage model will be completed for the project, and that the maximum flow capacity for SPS-1 will be adjusted as needed based on the updated modelled seepage flows from the reservoir.
2. Each pump would be driven by an electric motor.
3. Trash screens would be installed to protect the pumps.
4. The main pumps will normally operate automatically in response to CNL-1, Reach 7, stage triggers in a duplex configuration. The primary pump will turn on when the stage in CNL-1, Reach 7, rises to 25.0 ft NAVD88. The secondary pump will turn on if the stage in CNL-1, Reach 7, rises to 25.5. All pumps will turn off when the stage in CNL-1, Reach 7, recedes to 24.0 ft NAVD88. All pumps will turn off when the stage in the reservoir East Cell reaches its NFSL of 51.7 ft NAVD88. The assignment of the primary and secondary pump for seepage pumping will automatically alternate between the two main pumps to balance annual runtime of the main pumps. During times when one or both main pumps is/are out of service, the auxiliary pump may be used for seepage pumping.

Additional information about SPS-1 is provided in **Section A.12**.

A.6.4.4 Above Ground Impoundment Pump Stations (AGI-PS-1 and AGI-PS-2)

As part of the construction of the reservoir, the southernmost AGI within the Basinger Tract, R12, will be removed/demolished along with its two inflow pump stations and outfall structure. AGI R12 has an area of approximately 900 acres (ac) and is part of the permitted stormwater management system (SFWMD surface water management permit number 28-00146-S) that serves the citrus groves within the Basinger Tract, on the north side of the Project site. To ensure that this existing stormwater management system continues to function as permitted, it is proposed that a new AGI inflow pump station (AGI-PS-2) be constructed which will discharge to AGI R11; and a new AGI (AGI-1) be constructed, including an inflow pump station (AGI-PS-1) and outfall structure (AGI-OS-1), as shown on **Figure A.1-4**, to replace AGI R12 and its structures. During the PED phase of the Project, the design of pump stations AGI-PS-1 and AGI-PS-2 and these other proposed modifications to the Basinger Tract stormwater management system will be finalized based on additional review and coordination with the Basinger Tract property owner. See **Table A.1-1** for additional information about proposed pump stations AGI-PS-1 and AGI-PS-2.

A.6.5 Canals

A.6.5.1 Canal C-38

C-38 is an existing canal that connects the S-84 structure to Lake Okeechobee. Water from Lake Okeechobee would be back pump through this canal to the PS-1 pump station at the S-84 structure location.

A.6.5.2 Canal C-41A

C-41A is an existing canal that will connect the inflow/outflow canal to S-84 structure. Flow pumped from PS-1 would travel through this canal to the inflow/outflow canal and then be pump in LOCAR via PS-2. Releases from LOCAR will flow into the C-41A via structures described in **Section A.6** and the Inflow-Outflow Canal.

A.6.5.3 Reservoir Perimeter Canal (CNL-1)

CNL-1 is the perimeter canal that surrounds the reservoir and collects seepage and returns it to the reservoir via seepage pumps at SPS-1. Adjacent properties that previously drained through the LOCAR site to the C-41A canal will, continue to do so via their proposed offsite overflow structures (OOS-1 through OOS-8), which will discharge to CNL-1.

The design criteria established for structure CNL-1 are the following:

1. A flow capacity based on seepage estimates in **Section A.9** and calculated stormwater flows.
2. A flow velocity of 1.5 ft per second through canal.

Canal bottom width is 16 ft with a bottom elevation that varies around the reservoir based on the topography. Side slopes would be 3:1 (H:V).

CNL-1 is represented in the proposed condition HEC-RAS model of the Perimeter Canal (CNL-1) system described in **Annex A-2.6**.

A.6.5.4 Reservoir East Inflow-Outflow Canal (CNL-2)

CNL-2 connects the C-41A canal to the PS-2 pump station and outflow structures.

The design criteria established for structure CU-1 are the following:

1. A minimum flow capacity of 1,500 cfs.
2. A maximum flow velocity of 1.5 ft per second on approach to the pump station.

The bottom width of the canal is 80 ft, based on connecting it to the pump station intake bay. Side slopes would be 3:1 (H:V).

A.6.5.5 Reservoir West Inflow-Outflow Canal (CNL-3)

CNL-3 connects the CU-2 structure to the CU-3 structure.

The design criteria established for structure CNL-3 are the following:

1. A minimum flow capacity of 1,500 cfs.
2. A flow velocity of 1.5 ft per second through the canal.

Canal bottom width is 50 ft with side slopes would be 3:1 (H:V).

A.6.6 References

Ansar, M., and Z. Chen. 2009. Generalized flow rating equations at prototype gated spillways. Technical Paper, *ASCE J. Hydraul. Eng.* 135(7):602-608.

Brunner, G.W. 2016. HEC-RAS, River Analysis System Hydraulic Reference Manual. U.S. Army Corps of Engineers Hydrologic Engineering Center.

Corps and SFWMD. 2007. Central and Southern Florida Project, Comprehensive Everglades Restoration Plan, Programmatic Regulations, Six Program-Wide Guidance Memoranda. U.S. Army Corps of Engineers Jacksonville District and South Florida Water Management District. July 2007. Available online at: <https://www.evergladesrestoration.gov/cgm>

SFWMD (South Florida Water Management District). 2015. Atlas of Flow Computations at Hydraulic Structures in the South Florida Water Management District. Technical Publication: HHB Report # 2015-001. The Hydraulic Design Unit, Applied Hydraulics Section, Hydrology and Hydraulics Bureau, Operations Engineering & Construction Division, South Florida Water Management District.

A.7 Geotechnical Considerations for Construction

The following sections summarize local geologic and geotechnical data gathered from near the LOCAR site. It presents background information gathered from previous nearby investigations as well as updated geotechnical data gathered from a 2023 investigation. Additional geotechnical data can be found in the annexes to this appendix. This section also provides geotechnical material and Project recommendations for the future PED phase of the Project.

A.7.1 Geotechnical Data Review

Existing available geotechnical data, site assessments, and associated laboratory materials within and near proximities of the LOCAR were initially reviewed to determine the nature and engineering properties of the natural ground soils and subsurface conditions to evaluate the feasibility of the proposed Project. Among the geotechnical field exploration programs and data reviewed, as part of this feasibility evaluation of the LOCAR site, there was a preliminary summary of soils and shallow subsurface geological characteristics on a partial proposed Project footprint. This referenced report was published by the Corps in 2017. Most of the existing data available consisted of borehole advancement and Standard Penetration Test (SPT) sampling conducted using rotary drilling equipment.

Figure A.7-1.1 shows the approximate location of the available test borings previously performed in proximity to the proposed LOCAR site. The boring logs and laboratory test results from existing geotechnical reports were reviewed to define preliminary engineering properties of the existing soils within the Project Area to be used in the seepage and stability analyses of the conceptual embankment cross sections. The preliminary engineering properties were then refined based on the LOCAR geotechnical investigation described in detail in **Section A.7.2**.

The following list summarizes background references reviewed for this feasibility study.

1. Ardaman & Associates, 2005. Geotechnical Investigation, Lake Okeechobee Watershed Project. Report prepared for the Corps.
2. Campbell, K.M., 1990. Summary of the geology of Glades County, Florida. Florida Geological Survey Open File Report 30, 17 p.
3. Challenge Engineering & Testing, Inc., 2007. Lake Okeechobee Watershed Geotechnical Investigation Report. Report prepared for the Corps, 812 p.
4. Challenge Engineering & Testing, Inc., 2008. Lake Okeechobee Watershed Project, Phase II Geotechnical Investigation Report. Report prepared for the Corps dated July 2008, 242 p.
5. Scott, T.M., 1988. The lithostratigraphy of the Hawthorn Group (Miocene) of Florida. Florida Geological Survey Bulletin No. 59, 148 p.
6. Scott, T.M., 1988. The lithostratigraphy of the Hawthorn Group (Miocene) of Florida. Florida Geological Survey Bulletin No. 59, 148 p.
7. Corps, 2013. Comprehensive Everglades Restoration Plan Aquifer Storage and Recovery Pilot Project, Final Technical Data Report. Report prepared by the Corps, dated December 2013, 340 p. plus Appendices.
8. Corps, 2017. Preliminary summary of soils and shallow subsurface geological characteristics on the footprints of the proposed K-42 and K-05 aboveground storage sites, Highlands and Glades

Counties, FL for the Lake Okeechobee Watershed Restoration Project. Memorandum for record dated 10 October 2017, 2 p.

9. U.S. Geological Survey. 2001. Estimation of Infiltration Rates of Saturated Soils at Selected Sites in the Caloosahatchee River Basin, Southwester Florida, USGS Open-File Report 01-65.
10. GFA 2019. Geotechnical Exploration Report, Culvert Replacement Construction Project, Phase II. Homestead and Okeechobee, FL. Prepared for SFWMD, January 28, 2019.
11. AMEC, 2008. Report of Geotechnical Exploration, Brighton Site, Highlands County, FL. Prepared for Verenium Corporation, Dec. 2008.
12. Ardaman & Associates, 2011. Report of Limited Geotechnical Exploration, Proposed Bassinger Farm Design Site, Highlands County, FL. Prepared for Royal Consulting Services, Inc., June 25, 2011.
13. SFWMD, 2015. Seepage Investigation of the Caulkins Water Farm Pilot Project, Martin County, Florida, Technical Publication WS-37, September 2015.
14. SFWMD, 2019. Hydrogeology of the Caulkins Water Farm Project, Martin County, Florida, Technical Publication WS-49, July 2019.

The reports referenced above provided background geotechnical data that was used to set up the preliminary models for this report and to complement the LOCAR geotechnical investigation. Several previous references and borings were reviewed to determine a preliminary soil profile and assist with determining material properties. **Table A.7-1** lists background borings reviewed from the references listed above. **Table A.7-2** lists investigations from the LOCAR Geotechnical Data Report presented in **Annex B-1**. Approximate boring locations are shown on **Figure A.7-1.1**.

Table A.7-1. Background Borings near Project Area.

Boring ID(s)	# of Borings	Reference
CP04-LOWSP-CB-0005	1	(1) Ardaman & Associates, 2005
CP06-LOWSP-CB-0013 to -0023	11	(3) Challenge Engineering & Testing, 2007
CP08-LOWSP-CB-0036 to -0041	6	(4) Challenge Engineering & Testing, 2008
CP17-CB-0048, -0049, -0051	3	(8) Corps, 2017
TB-08 to -10	3	(10) GFA, 2011
SB-01 to -08, B-01 to -14	22	(11) AMEC, 2008
TH-1 to TH-23	23	(12) Ardaman & Associates, 2011

A.7.2 LOCAR Geotechnical Investigation

A geotechnical investigation by J-Tech was performed between May and August 2023. Onsite investigations consisted of a series of standard penetration test (SPT) soil borings, Piezocone (CPTu) soundings, temporary piezometers, in-situ testing for hydraulic conductivity estimates by double-ring infiltrometers and slug testing, as well as laboratory testing on selected soil samples including grain-size distribution, moisture content, fines content, Atterberg limits, consolidation, and triaxial shear strength. Approximate boring locations from previous references and the initial LOCAR site-specific geotechnical investigation are shown in **Figure A.7-1**. **Table A.7-2** shows a brief summary from the initial geotechnical investigation and Geotechnical Data Report presented in **Annex B-1**.

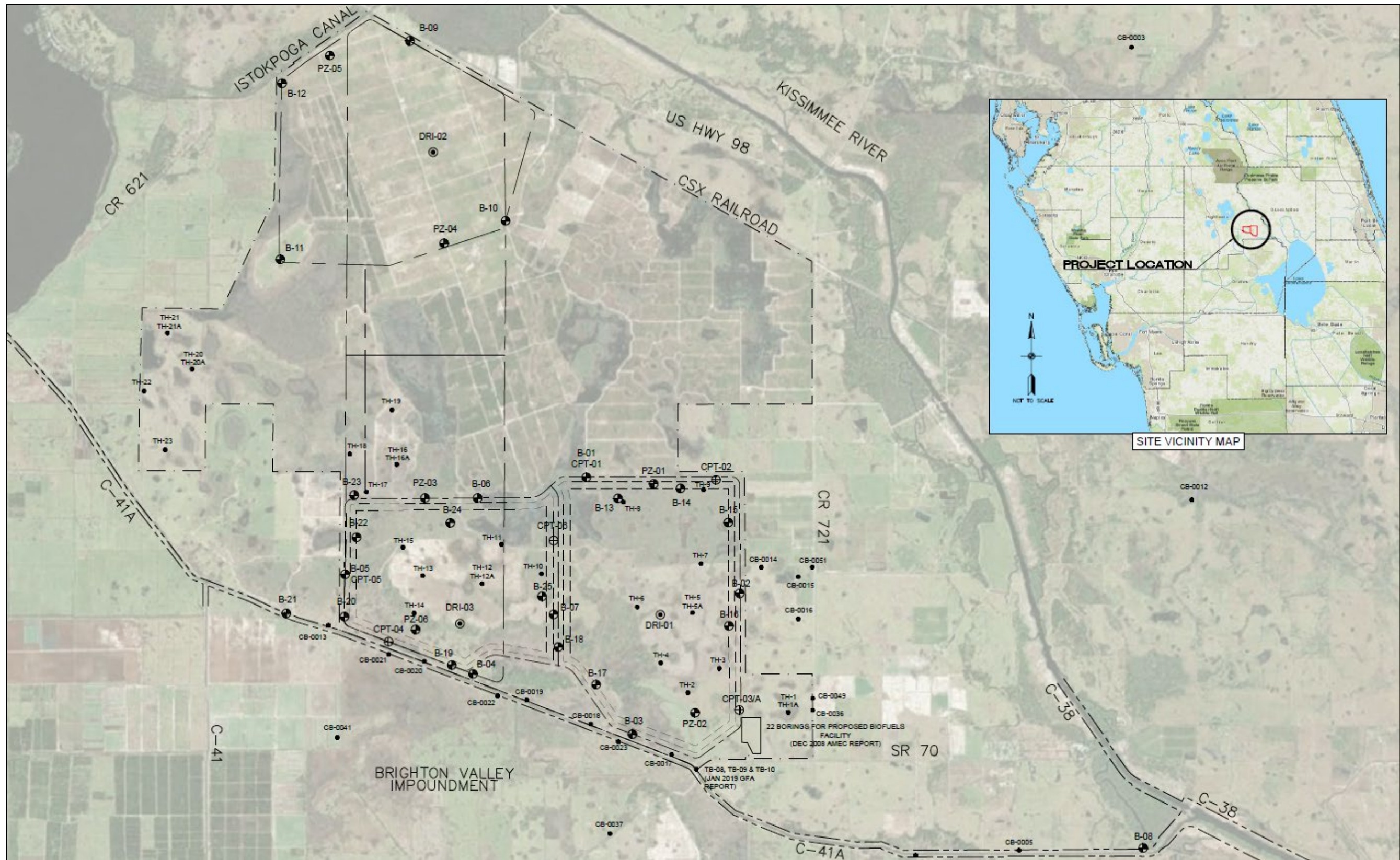

Figure A.7-1. Existing boring locations (background borings) and J-Tech's 2023 investigation.

Table A.7-2. Geotechnical Investigation at Project Area.

Investigation ID(s)	# of Locations	Reference
(SPT) B-1 to -12, PZ-1 to -5	31	(Annex B-1) Ardaman & Associates 2023
(CPTu) CPT-1 to -12	12	
DRI-1 to -3	3	

A.7.3 Stratigraphy

A general subsurface profile was considered for the purpose of the preliminary analyses. This profile was derived from the geotechnical exploration data collected and data reviewed from the references mentioned above in **Sections A.7.1** and **A.7.2**. The soil profiles from the background borings and J-Tech's LOCAR exploration were analyzed when assigning soil strata strength and hydraulic conductivity properties. In general, the borings yielded more permeable materials as the locations approached the C-41A canal within reasonable depths for a seepage barrier (i.e., up to 60 ft). Soil borings reviewed showed, in general, sandy soils for most of the area of the proposed site for LOCAR. These soils vary from very loose to dense sand (SP), sand with silt (SP-SM), sand with clay (SP-SC), silty sand (SM), and clayey sand (SC), with occasional areas of soft to stiff clay with varying amounts of sand (CH). Marine deposits shown as shell fragments on soil layers 30 ft below the existing ground surface were observed in most of the borings.

The generalized profile in **Table A.7-3** below represents the stratigraphy used for the analyses. As mentioned above, more clayey materials were present in borings as they moved north away from the C-41A canal. However, hydraulic conductivity properties for the seepage model would improve, so the assumed soil profile shows the cutoff wall approach works in the most permeable profile. For the slope stability model, embankment materials are unchanged, and near-surface materials affecting slope stability remain sandy in the upper 30 ft across the site. Therefore, the slope stability model remains consistent with the assumed profile.

Table A.7-3. Generalized Subsurface Soil Profile.

Typical Elevation (ft NAVD88)	Material - Description
GSE to -20	Upper Sands (Generally SP, SP-SM, SP-SC)
-20 to -50	Intermediate Sands (SP-SM, SP-SC, SM, SC)
-50 to -100	Sand with Silt to Sandy Clay (SC, SM, ML, MH, CL, CH)

GSE-Ground Surface Elevation

Typical groundwater levels measured during the LOCAR investigation were approximately 2 to 6 ft below the ground surface. During the wet season, water may be expected at or near the ground surface in some locations. Reference the Ardaman Geotechnical Data Report (GDR) for additional groundwater elevation information.

A.7.4 Piezometers

Piezometers were installed at six locations across the site including two locations north of the site in the previously considered alternative. Each of the four locations within the chosen alternative and one of the two in the previous alternative included partner instruments installed in separate boreholes at different depths. At these locations, a shallow and deep depth were installed to provide a near surface and deeper groundwater reading; the separate depths were not chosen based on anticipated confined aquifer conditions but were meant to provide additional data. Generally, the upper screened interval is 5-feet

(except PZ-06a is 10-feet) and located within a higher-conductivity sand, while the lower screened interval is 10-feet and in lower-conductivity material. **Figure A.7-1** shows a plot of limited groundwater readings and rainfall data from 2023 and early 2024.

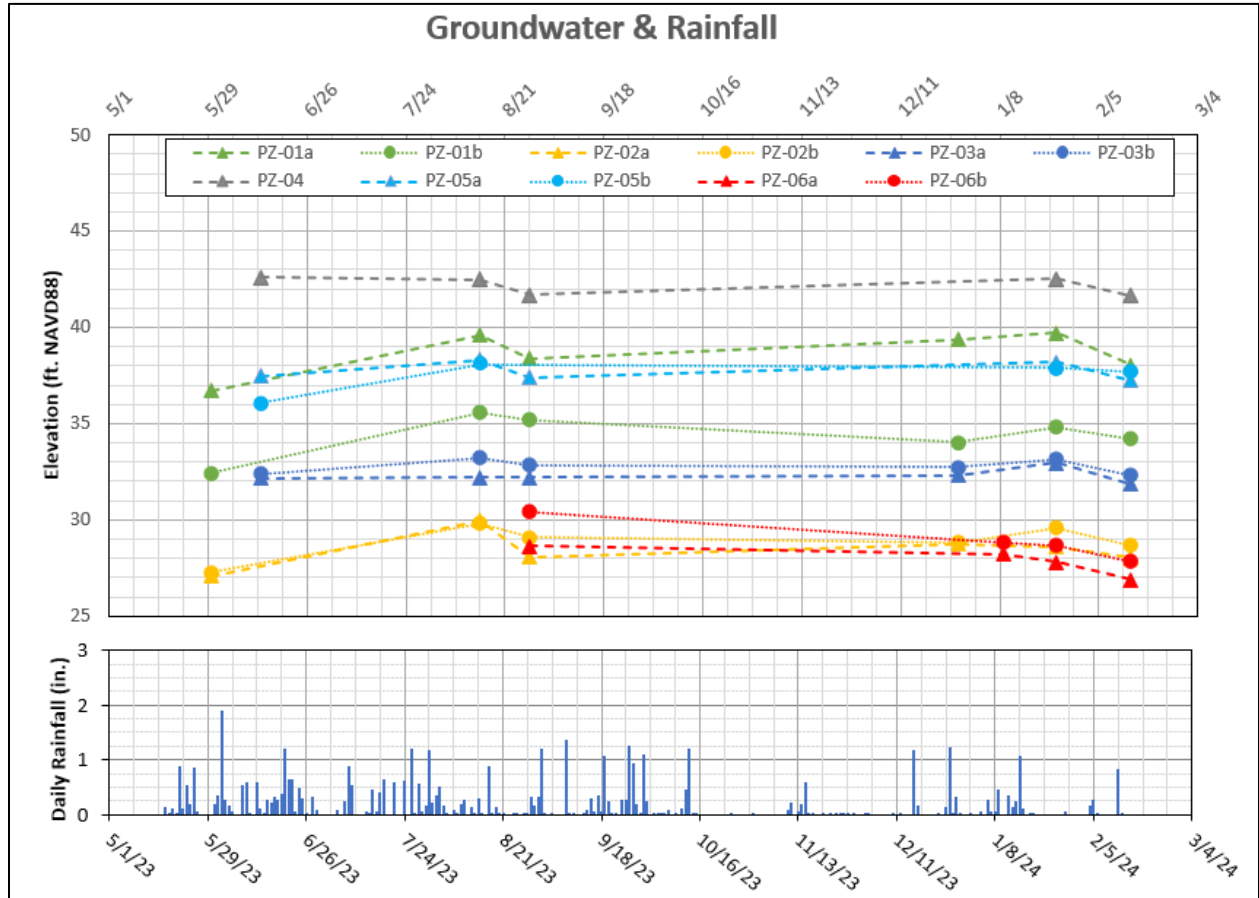

Figure A.7-2. Piezometer Groundwater Readings and Rainfall Data.

More frequent reading intervals during PED may help identify trends in the groundwater data. These instruments do create a conduit to the underlying soil profile, and it is recommended to identify the instruments and abandon them prior to filling the reservoir.

A.7.5 Laboratory Test Results

Laboratory test results performed on samples from the geotechnical site explorations conducted for the earlier proposed reservoir site (previously named K-42) under LOWRP, provided in reference No. 8 listed in **Section A.7.1**, were reviewed originally to define the engineering properties for preliminary seepage and stability analyses for the conceptual design of the LOCAR embankments. Those results were compared to the LOCAR Geotechnical Exploration and adjusted based as needed given the updated results.

The laboratory test results reviewed include:

- Gradation (ASTM D422), moisture content (ASTM D2216)

- Percent passing the No. 200 sieve (ASTM D1140)
- Moisture content (ASTM D2216)
- One-Dimensional Consolidation (ASTM D2435)
- Consolidated Undrained (CU) and Unconsolidated Undrained (UU) triaxial
- Hydraulic Conductivity with flexible wall permeameter (ASTM D5084)
- Corrosivity tests (FDOT)
- Moisture Density Relationship (Standard Proctor – ASTM D698)

Laboratory results from the LOCAR geotechnical exploration are included in the GDR. Results from the southernmost borings along the C-41A canal have been relatively consistent with the early assumptions from the Corps background report; however, results from field slug testing and DRIs have indicated it is reasonable to use lower hydraulic conductivity values.

A.7.6 Seismicity

The Uniform Building Code Seismic Zone Map (Gravity Dam Design Engineer Manual 1110-2-2200 by the Corps, dated June 1995) shows that the entire state of Florida is in seismic Zone 0. No capable faults or recent earthquake epicenters are known to exist near the Project site.

SFWMD's requirements for seismic evaluation of CERP high-hazard potential dam projects, are described in DCM-6. Although southern Florida is a low seismicity region, the possibility exists for earthquake-imposed seismic loads on Project structures. The potential earthquake loading is low enough that compacted embankments should not be damaged, but the natural sand foundations of the embankments could potentially be affected.

Loose, saturated, sandy soils are susceptible to liquefaction (loss of strength from shaking). This loss of strength could lead to sliding or settlement, possibly resulting in an embankment failure. DCM-6 presents the design criteria developed jointly by the SFWMD and the Corps for evaluating liquefaction potential of CERP impoundments.

A.7.7 Borrow

The borrow material for LOCAR reservoir embankments will be derived from the upper surficial sand, sand with silt/clay, and silty sands. Sources of borrow will include the excavation of the reservoir perimeter water canals and borrow areas within the reservoir footprint. Material suitable for embankment fill appears readily available throughout the Project Area to depths of 20+ ft. Additional field exploration within the reservoir site is expected during the PED and construction phases to further define the best borrow materials sources for materials with higher fines content.

A.7.8 Excavations

Surficial soils and organic material encountered within the LOCAR embankment areas will be stripped during preparation of the embankment's foundation. The topsoil stripping procedure is expected to be performed with agricultural scrapers and tractors. Areas with organic or finer material may be disked to promote drying before disposing or relocating. Areas requiring deeper or wet materials can be excavated with conventional earth moving equipment where dozers push the soil into piles and excavators load the

material into dump trucks. The stripped materials can be transported to the perimeter of the active construction areas and placed in berms for later use in landscaped areas.

Based on the subsoil conditions on the Project site during the geotechnical investigation, no rock excavation is expected.

Excavation of the canals and borrow areas should be performed as follows: remove the surficial soils should and transport reusable material to the future embankment location or other stockpiles. Excavate the underlying sandy materials using conventional hydraulic excavators and stockpile alongside the perimeter canals or borrow areas to promote drainage of excess moisture and to qualify for reuse.

A.7.9 Design Parameters

Preliminary design parameters for the LOCAR construction are included in **Section A.8**.

A.8 Geotechnical Embankment/Dam Design

A.8.1 General

This section summarizes the evaluation of the preliminary embankment cross sections proposed for development of LOCAR. The embankment design described below in **Sections A.8.2** and **A.8.3** is based on industry standard design criteria as well as various draft Design Criteria Memoranda (DCM) issued jointly by SFWMD, the Corps, and FDEP.

This study utilized information obtained from a geotechnical site investigation of the Recommended Plan site and its associated laboratory testing program (documented in the geotechnical report in Annex B-1); and data obtained from other previous soil boring programs for nearby sites. A more detailed field exploration during the PED phase must be performed for the LOCAR site to better understand the behavior of the in-situ materials and confirm that the preliminary design assumptions are valid for the extent of the Project. In addition, future investigations will provide information about the soil material characteristics when excavated, placed, and compacted, and assess suitability of available borrow resources.

Stability, seepage control, erosion protection, and settlement were considered. The selected embankment cross sections were developed based on the preliminary design for the LOCAR during this feasibility study.

The LOCAR dam will include several dam safety features which are incorporated into the preliminary seepage and stability models as described below. Critical definable safety features considered include the following:

- Foundation preparation
- Downstream foundation drain
- Soil bentonite seepage cutoff wall
- Soil cement upstream slope protection
- Downstream stormwater toe swale
- Erosion protection at pipe outlets into perimeter canal

A.8.2 Dam Safety Features

A.8.2.1 Foundation Preparation

Foundation preparation will include clearing and grubbing of existing vegetation as well as removal of any existing irrigation and underground appurtenances. Foundation preparation is modeled by removing 2 ft of existing surface material for clearing/grubbing. Additionally, a 500-ft wide strip, measured normal to the embankment toe, was modeled with 3-ft of material removed for embankment fill excavation.

A.8.2.2 Downstream Foundation Drain

The downstream foundation drain is a seepage collection system consisting of a chimney drain, sand blanket, and toe drain. The chimney drain consists of a 2.5-ft width FDOT 902-4 silica Filter Sand (Filter Sand) vertical drain meeting the requirements of FDOT 902-4. The chimney connects to the blanket drain, which consists of a minimum 18-inch-thick layer of Filter Sand overlying a minimum 2-ft-thick layer of local

Clean Sand of less than 5 percent material passing the No. 200 sieve. The blanket drain drains into a 12-inch HDPE toe drainpipe filtered by FDOT No. 89 stone. Material properties used for the model are described in subsequent sections.

A.8.2.3 Soil Bentonite Seepage Cutoff Wall

The soil bentonite seepage cutoff wall (SBW) consists of a minimum 3-ft width of native materials mixed with bentonite to create a uniform mixture of materials to reduce seepage across the dam embankment and foundation materials. Material properties used for the model are described in subsequent sections. The proposed depth for the cutoff wall is 60 ft below the existing ground surface.

Based on the subsurface investigations, there is not a continuous layer of lower permeability material in the soil profile to consider the SBW as a true “cutoff wall.” Rather, the purpose of this SBW will be to reduce the hydraulic gradient and seepage across the embankment such that seepage and gradients meet acceptable standards.

A.8.2.4 Soil Cement Upstream Slope Protection

The soil cement upstream slope protection guards against erosion and wave runoff on the upstream side and crest of the dam embankment. It is at least 12 inches thick, providing an additional buttressing effect in addition to erosion protection. The soil cement includes cemented fines that could temporarily reduce permeability and act as a seepage barrier; however, the material is unreinforced and will develop cracking over time. The soil cement is not modeled for the feasibility-level seepage and slope-stability analyses.

A.8.2.5 Stormwater Toe Swale

The perimeter stormwater Swale is designed to collect the stormwater runoff from the downstream slope, any potential seepage through the face of the embankment, and seepage collected by the foundation drain. Collected water then is conveyed through culvert pipes under the perimeter road to the perimeter canal.

A.8.2.6 Erosion Protection at Pipe Outlets into Perimeter Canal

Erosion protection systems, such as concrete aprons or rip-rap revetment, are considered at the culvert outlet locations at the perimeter canal.

A.8.3 Conceptual Dam Embankment

A.8.3.1 Embankment Description

An embankment design has been developed to use materials from available onsite borrow sources and required canal excavations and to minimize processing of the excavated materials for embankment construction. A filter (chimney drain) is provided for internal piping control and drainage and to control the phreatic surface in the downstream shell. The specific filter gradation and inherent appurtenances will be designed during the PED phase of the Project.

The downstream 3H:1V slope of the embankment will be covered with a thin layer of material with organics which will be grassed for erosion protection and maintained in accordance with SFWMD standard design criteria.

A.8.3.2 Typical Sections

Representative typical sections have been developed for several locations throughout the proposed LOCAR footprint. Geometry used for the geotechnical analyses utilized these typical sections along with

material properties from the available background data. Four sections were analyzed during the modelling process as follows:

- Typical Section A – East/est embankments of East/West Cells (typical section that represents the condition where the existing ground surface [excluding irregular ground surface elevations at existing ditches/levees] is at its average elevation along the footprint of the perimeter dam).
- Typical Section B – South embankment of East Cell (typical section that represents the condition where the existing ground surface [excluding irregular ground surface elevations at existing ditches/levees] is at its lowest elevation along the footprint of the perimeter dam).
- Typical Section C – North embankment near the northeast corner of East Cell (typical section that represents the condition where the existing ground surface [excluding irregular ground surface elevations at existing ditches/levees] is at its highest elevation along the footprint of the perimeter dam).
- Typical Section D – Divider dam between East Cell and West Cell (typical section that represents the condition where the existing ground surface [excluding irregular ground surface elevations at locations of existing ditches/levees] is at its average elevation along the footprint of the divider dam).

Figure A.8-1 shows the location plan with each of the four typical section locations, and **Figure A.8-2.A** shows Typical section A as an example. Each of the four Typical Sections are included in **Figure A.8-2.A** through **2.D** in **Annex B-2** to provide full-size figures with more detail than the figure below.

The seepage and stability analyses discussed herein are for the NFSL Elevation of 51.7 ft NAVD88. A surcharge height of 4.6 ft above the NFSL, corresponding to the PMF/PMP, was also analyzed. A rapid drawdown condition was evaluated during which the water level in the reservoir is lowered to the ground surface elevation of around 32 ft NAVD88 in less than 24 hours—a rate faster than could reasonably be achieved during operations. The seepage and stability analyses for rapid drawdown conditions were performed four times during the drawdown period using a uniform time increment for the NFSL elevation of 51.7 ft NAVD88 and the PMF/PMP elevation of 56.3 ft NAVD88, respectively. The results of seepage and stability analyses with the lowest factor safety are presented herein.

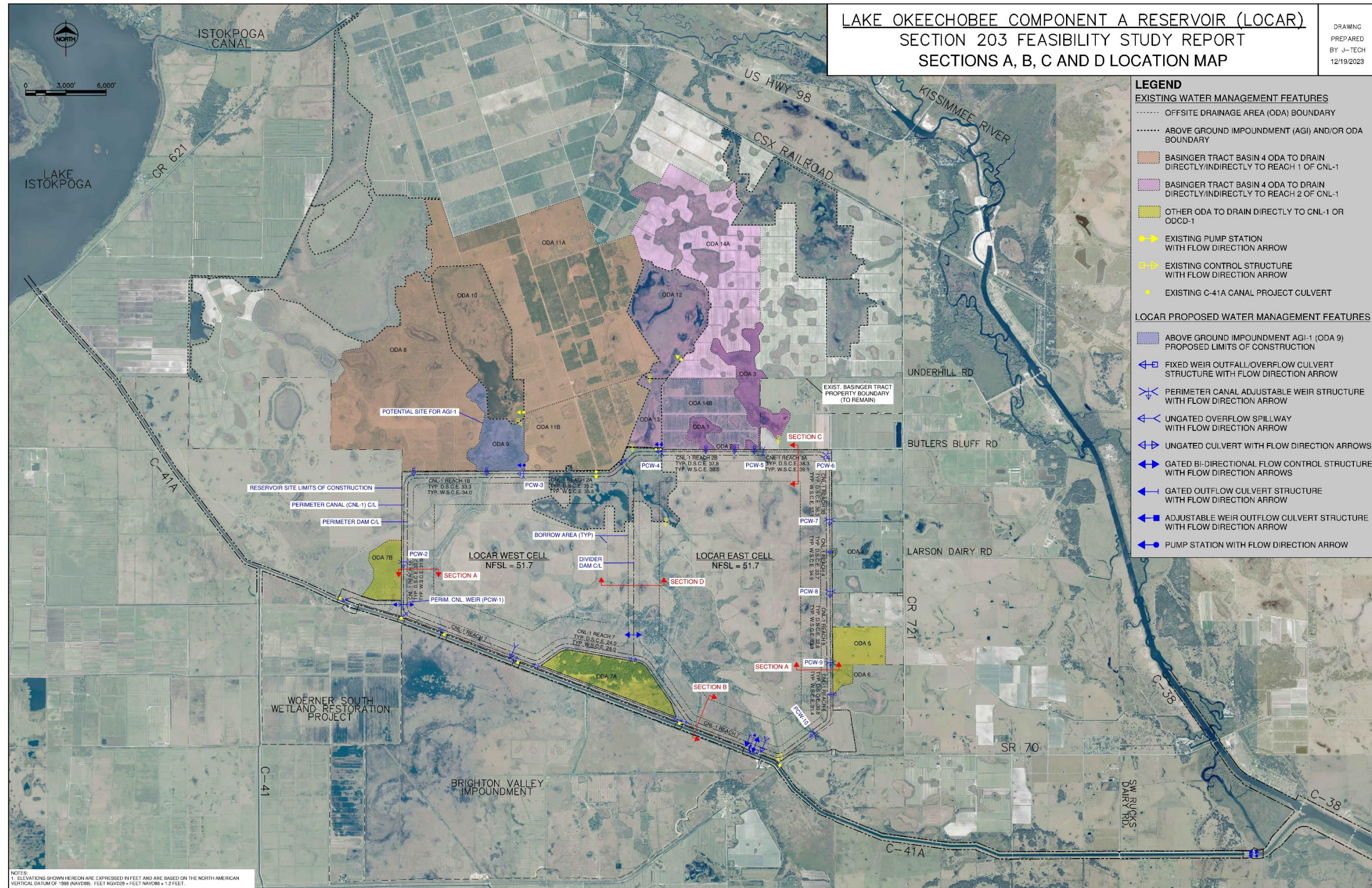

Figure A.8-1. Typical Sections A, B, C and D Location Map.

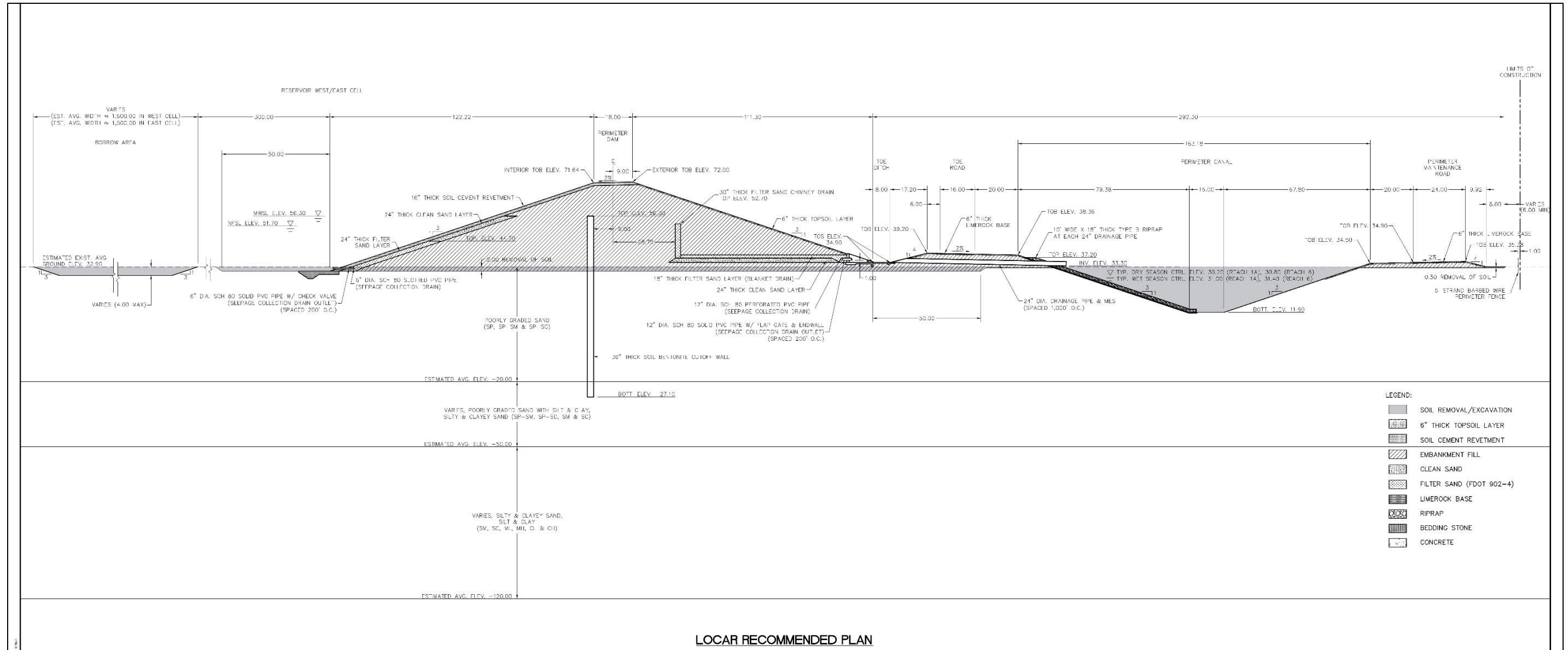

Figure A.8-2. Typical Section A – Perimeter Dam and Perimeter Canal.

A.8.4 Design Criteria

A.8.4.1 Sources

Corps Design Manuals:

- Engineering Manual, EM 1110-2-1901, Seepage Analysis and Control for Dams, 09 September 1986
- Engineering Manual, EM 1110-2-1902, Engineering and Design: Slope Stability, 31 October 2003
- Engineering Manual, EM 1110-2-1913, Design and Construction of Levees, 30 April 2000
- Engineering Manual, EM 1110-2-2300, Earth and Rock-Fill Dams, General Design and Construction Considerations, 30 July 2004

Acceler8 Design Criteria Team, Design Criteria Memoranda:

- 'Hazard Potential Classification,' DCM-1, 12 September 2005
- 'Minimum Dimensions of Embankments (Levees and Dams), Ramps, Pull Outs, and Access Roads,' DCM-4, 9 May 2008
- 'Clarification of 2.2.3 Minimum Crest Width Requirements,' DCM-4 Clarification, 27 February 2009

A.8.4.2 Embankment Slope Stability Factors of Safety

The minimum required factors of safety for each embankment design case are as follows:

Design case	Factor of safety
End of Construction	1.3
Steady Seepage at Normal Pool Level	1.5
Steady Seepage with Surcharge Pool.....	1.4
Steady Seepage with Earthquake Loading.....	1.1
Rapid Drawdown from Normal Pool.....	1.3
Rapid Drawdown from Surcharge Pool.....	1.1
Seepage for Soil Heave & Piping (Ref. Section A.8.7)	3.0

It is important to note End of Construction and Steady Seepage with Earthquake Loading analyses are not presented herein and will be evaluated in the future during the PED phase of design.

A.8.4.3 Water Levels

The Maximum Hazard classification of this embankment requires LOCAR to be sized to store the PMP as described in **Section A.5.2**. A PMP of about 4.6 ft was used as the basis for the work presented. The total embankment height will depend on the normal water level plus the freeboard requirements. Freeboard allowance is determined from the effects of wind and rainfall and other considerations as described in **Section A.5.4**.

A.8.4.4 Seismic Loading

Pseudo-static analyses that simulate earthquake activity will be performed in the future PED phase of the Project and are not presented herein.

DCM-6 requires an evaluation of the liquefaction potential of the embankment foundations. The method of evaluation is based on assessment of continuous SPTs in boreholes and comparison with standard design charts. This evaluation will be made in the future PED phase when additional field investigation data is available.

A.8.5 Embankment/Dam Materials

A.8.5.1 General

Effective utilization of the available onsite materials during construction will tremendously affect the economic feasibility of the LOCAR. Materials to be used for embankment construction are expected to be obtained from perimeter canals and borrow areas excavated within the LOCAR interior.

Additional field explorations might be required to further define and identify some of the construction materials within the site.

A.8.5.2 Subsurface Profile

The available materials at the LOCAR site appear to be consistent and have good potential to be reused during the construction. The generalized subsurface profile is provided in **Section A.7.3**.

Soil borings performed during the most recent geotechnical investigation and from the previous references listed in **Section A.7.1** were used to develop the preliminary soil profile across the LOCAR site. The location of the soil borings is shown in **Figure A.7-1**. The Geotechnical Data Report is presented in **Annex B-1**. A more detailed site-specific field exploration must be performed within the LOCAR site during the PED phase.

A.8.5.3 Embankment Materials

Based on the field explorations performed within the LOCAR site, embankment materials may be excavated from the surficial soils and the upper sandy soils from both the perimeter canals and the borrow areas within the reservoir. These materials consist of sandy soils with silt and clay with no more than 20 percent fines from the total volume.

The chimney drain and drainage blanket will consist of graded, filter-quality material meeting the filter requirements for the silty and clayey sand proposed for the embankment fill. A graded filter will also be installed below the upstream slope protection (i.e., soil cement) to allow drainage from the embankment material during drawdown of the reservoir.

Continued exploration as design phases advance will more clearly define the material availability throughout the project area.

A.8.6 Material Properties

Material properties and soil parameters for the feasibility analyses were estimated using a combination of on-site testing and other sources including previous studies and published soils literature. Primarily, (10) Corps, 2017 and the LOCAR geotechnical exploration provided the basis for estimated hydraulic-conductivity parameters for the main strata considered in their generalized profile. A summary of

properties used in the analyses is presented in **Table A.8-1** below, and sensitivity analyses which varied these parameters are presented in the sections that follow.

For the seepage model, the hydraulic conductivity parameters of most of the materials used a saturated/unsaturated model type, where a hydraulic conductivity function is applied to the model and the relationship between pore-water pressure and hydraulic conductivity gets defined. The approximations used are available in the GeoStudio database. These soil-specific functions allow for the soils to account for water storage and matric suction as the water content decreases in the soil matrix.

It should be noted that although materials below are presented as “Units” A, B, C, and D below and in the 3D seepage model in **Section A.9 of Appendix A**, these units are not consistent, traceable stratigraphic units across the LOCAR. They are a simplified assumption that vary throughout the site.

Table A.8-1. Seepage and Stability Analysis Parameters.

Material Type	Sat. Unit Weight (pcf)	Friction Angle (degrees)	c' (psf)	Hydraulic Conductivity Material Model	Saturated k_h (cm/sec)	Anisotropy Ratio (k_h / k_v)
Cutoff (Soil-Bentonite) Wall	90	26	50	Saturated Only	1.0×10^{-6}	1
Embankment Fill	115	34	0	Saturated / Unsaturated	1.0×10^{-3}	2
Clean Sand (< 5% fines)	105	32	0	Saturated / Unsaturated	1.0×10^{-1}	1
FDOT 902-4 Silica Filter Sand	105	32	0	Saturated / Unsaturated	0.5×10^{-1}	1
Upper Sands – Unit A (SP, SP-SM, SP-SC)	110	32	0	Saturated / Unsaturated	1.0×10^{-2}	5
Silty to Clayey Sands – Unit B (Not used in 2D)	115	32	0	Saturated / Unsaturated	1.0×10^{-3}	10
Intermediate Sands – Sand with Silt and Sand with Clay – Unit C (SP-SM/SC, SM/SC)	115	35	0	Saturated / Unsaturated	5.0×10^{-3}	5
Silty/ Clayey Sand, Sandy Silt and Clay, Miscellaneous – Unit D (SM, SC, ML, MH, CL, & CH)	120	33	0	Saturated / Unsaturated	5.0×10^{-4}	10

cm/sec- centimeters per second; pcf-pounds per cubic foot; psf-pounds per square foot

A.8.7 Seepage Control

A.8.7.1 General

Seepage control has two principal design functions:

- The first function is embankment and foundation stability: pore pressures and hydraulic gradients must be controlled to protect the embankments and foundation from internal erosion (piping) and to ensure stability.

- The second function is to mitigate offsite impacts due to increased seepage.

This section describes the minimum measures required to ensure stability. Seepage computer modeling has been performed to evaluate seepage control.

A.8.7.2 Seepage Analysis

Seepage through the embankment and foundation under steady-state conditions was modeled using the computer program SEEP/W (GeoStudio 2021 R2), developed by GEOSLOPE International Ltd. of Calgary, Alberta, Canada. Seep/W is a two-dimensional, finite-element seepage modeling program that generates the phreatic surface, hydraulic head distribution, and flow quantities within a seepage domain.

Seepage analyses were performed for the typical embankment cross sections described and shown above in **Section A.8.3.2** with an NFSL water elevation of +51.7 ft NAVD88 and a PMF/PMP condition, which corresponds a maximum design water elevation of +56.3 ft NAVD88. The water level inside the reservoir was represented with a total fixed-head boundary of +51.7 and + 56.3 ft NAVD88 applied at the ground surface and the inside slope face of the embankment of each typical section. The approximate water-controlled level maintained in the perimeter canal, during the wet season, was represented with a fixed head boundary of +31 and +31.4 ft NAVD88 (Section A, Reach 1A and Reach 6, respectively), +24 ft NAVD88 (Section B, Reach 7), and +39.1 ft NAVD88 (Section C, Reach 3A) on the sloped faces and bottom of the perimeter canal, respectively. For the divider dam (Section D), an open potential drainage seepage face boundary applied to the downstream slope face and ground surface was considered. Section A, as modeled, represents two different reaches where the water control elevations during the wet season are set at +31 and +31.4 ft NAVD88. For the purpose of the analysis, the lower elevation represents a higher head difference from the reservoir water level, therefore there is potential for a higher exit gradient at the canal perimeter. The analyses models for each section do not include boundary conditions at the far edges and bottom of the model, to avoid any potential influence of the seepage results.

All the cross sections were extended a minimum of 800 ft to the upstream and downstream sides of the reservoir. Results of the seepage analyses were obtained in the form of total head and velocity distributions within the embankment and foundation soils and flow rates through the embankment and foundation. Results of the seepage analyses are presented in **Annex B-2**; and a summary of results is presented below in **Table A.8-2** and Section A shows much higher gradients (and lower resulting Factor of Safety) compared to sections B through D. This reflects a phenomenon in the model that resulted from a slight increase in the design perimeter canal surface for Section A. The raised surface crossed the modeled interface between “Unit A” and fill material, resulting in exit gradients through the lower hydraulic conductivity fill rather than Unit A. The result is increased gradients as shown in **Table A.8-2**, but similar flows to other sections as shown in **Table A.8-3**. This result highlights the potential sensitivity to materials at the seepage exit point, and the gradients near 0.3 may suggest a filtered exit or less steep slope should be considered at the perimeter canal.

Table A.8-3. The highest resultant exit gradients for each analysis at the slope face of the perimeter canal and the ground surface where seepage flows out were considered for the computed factors of safety against soil heave and piping and are summarized in **Table A.8-2**. The computed factors of safety for cross sections A, B, C, and D, meet or exceed the minimum required factor of safety of 3.0 for soil heave/piping.

The seepage rate from the LOCAR embankment into the perimeter water canal for cross sections A, B, and C, and for the ground surface for Section D computed from the SEEP/W model are summarized in **Table A.8-3**.

A soil-bentonite seepage wall is considered in the preliminary design embankment to force the seepage downward through the foundation and subsurface soil layers. The cutoff wall will be located through the embankment and extending from elevation +56.3 ft NAVD88 (above ground) to a minimum of 60 ft below the existing ground surface, which will vary between approximate elevations of -19 and -35 ft NAVD88. The foundation cutoff can be installed below the groundwater level by using the slurry method of trench excavation, during which the trench can remain opened by using a mixture of water and bentonite. The backfill of the cut-off wall will consist of a mixture of the excavated soils and processed commercial bentonite.

In addition, seepages during transient conditions such as rapid drawdown were preliminarily evaluated to determine differences in pore water pressure and internal phreatic surface within the embankment soils during an instantaneous drop of water elevation in the reservoir. Rapid drawdown conditions were modeled assuming pore water pressures within the embankment soils will dissipate within 24 hours of such an event. This rapid reduction in pore pressure is a conservative assumption, as actual dissipation is expected to occur at a slower rate and result in a higher Factor of Safety.

Results of the steady state conditions for normal pool and PMF/PMP are presented in **Figure A.8.7-1** through **Figure A.8.7-8**; and transient conditions for normal pool and PMF/ PMP are presented in **Figure A.8.7-9** through **Figure A.7.8-16** in **Annex B-2**.

Table A.8-2. Exit Gradients and Factors of Safety against Soil Heave/Piping.

Case Cross Section	Steady Seepage with Normal Pool				Steady Seepage with PMF/PMP			
	A	B	C	D	A	B	C	D
Exit Gradient	0.28	0.15	0.12	0.16	0.33	0.17	0.18	0.19
Critical Gradient, γ'/γ_w	0.76	0.76	0.76	0.76	0.76	0.76	0.76	0.76
Factor of Safety	2.7	5.1	6.3	4.7	2.3	4.5	4.2	4.0

Note: $\gamma' = \gamma_{sat} - \gamma_w$

Based on the results from the seepage analyses, Section A shows much higher gradients (and resulting Factor of Safety below the recommended 3.0 value) compared to sections B through D. There are likely several factors at play, but the magnitude of the change was surprising. It appears the model has a high sensitivity to the interaction between the perimeter canal surface and the materials modeled as fill material and “Unit A.”

In the model, the canal surface for Section A is above the modeled interface between “Unit A” and fill material, resulting in exit gradients through the lower hydraulic conductivity fill rather than Unit A. Based on review of the model, this is the primary difference with Section A producing the increased gradients shown in **Table A.8-2**. Section A does have flows that remain consistent to other sections as shown in **Table A.8-3**.

This result highlights the potential sensitivity to materials at the seepage exit point, and the gradients near 0.3 may suggest a filtered exit or less steep slope at the perimeter canal should be considered during PED.

Table A.8-3. Computed Seepage from the Reservoir.

Cross Section	Scenario	Upstream Pool Elevation (ft NAVD88)	Downstream Perim. Canal Elev. (ft NAVD88) **	Seepage (cfs/mile)
A (Reach 1A)	Normal Pool	+51.7	+31.0	3.1
	PMF/PMP	+56.3		3.8
	Normal Pool	+51.7	+30.2	3.2
A (Reach 6)	Normal Pool	+51.7	+31.4	3.1
	PMF/PMP	+56.3		3.8
	Normal Pool	+51.7	+30.8	3.1
B (Reach 7)	Normal Pool	+51.7	+24.0	3.5*
	PMF/PMP	+56.3		4.1*
C (Reach 3A)	Normal Pool	+51.7	+39.1	2.4
	PMF/PMP	+56.3		3.4
	Normal Pool	+51.7	+38.3	2.6
D (Divider Dam)	Normal Pool	+51.7	Ground Surface (Avg. +30)	3.6
	PMF/PMP	+56.3		4.4

*Estimated seepage includes about 0.1 cfs/mile moving towards the C-41A Canal.

** Perimeter Canal Elevations shown are the typical max (wet season) and min (dry season) control elevations from Fig A.8-1

A.8.8 Stability

A.8.8.1 General

Stability of the proposed LOCAR embankment was evaluated for embankment heights from 31 to 46 ft above the average elevation of the existing ground surface. The stability analyses were performed using the pore pressure distributions determined from the results of the seepage analyses presented in **Figure A.8.7-1** through **Figure A.8.7-8** in **Annex B-2**.

A.8.8.2 Material Parameters

The stability analyses were performed using the shear strength and unit weight parameters presented in **Table A.8-1**. These engineering properties were selected for the conceptual design cross sections of the LOCAR based on experience with similar soils on prior projects, evaluation of the test borings performed at the LOCAR site, and a review of the references previously mentioned in **Section A.7.1**.

A.8.8.3 Embankment Slope Stability Analysis

The stability analyses for the proposed LOCAR dam embankments were performed using the computer model SLOPE/W (GeoStudio 2021 R2), developed by GEOSLOPE International Ltd. of Calgary, Alberta, Canada. SLOPE/W is a fully integrated slope-stability analysis program. The computer software determines the critical failure surface for each failure mode by converging on the failure surface through an iterative procedure. Stability analyses on the critical failure surfaces identified in the search routine were completed using Spencer's method, which satisfies total force and moment equilibrium. The stability analyses were performed using the pore pressure distributions determined from the results of the SEEP/W seepage analyses. Pseudo-static analyses should be performed in the future PED phases of the Project and are not presented in this memorandum.

The results of the stability analyses and the parameters used are presented in **Figure A.8.8-1** through **Figure A.8.8-24** in **Annex B-2**. The minimum required factor of safety and the computed factors of safety

for each case are presented below in **Table A.8-4**. As noted, the computed factors of safety, in all cases, meet or exceed the minimum required factors of safety.

For the purpose of this study, stability of the full embankment is of primary concern. Therefore, this study focused on deeper embankment potential failure slip surfaces. Slip failure surfaces with a depth of 5 ft or less from the slope face were not included or considered in these analyses. These shallow types of failures are considered surficial sloughing, which could be addressed and avoided by using surface erosion protection systems, maintenance and monitoring, and good vegetation cover.

Table A.8-4. Results of Stability Analysis.

Scenario	Minimum Required Factors of Safety	Calculated Factor of Safety	
		Upstream Slope	Downstream Slope
Typical Cross Section A			
Steady State Seepage with Normal Pool	1.5	1.95	2.06
Steady State Seepage with PMF/PMP Pool	1.4	1.97	1.94
Rapid Drawdown from Normal Pool	1.3	1.73	N/A
Rapid Drawdown from PMF/PMP Pool	1.1	1.72	N/A
Typical Cross Section B			
Steady State Seepage with Normal Pool	1.5	1.98	2.05
Steady State Seepage with PMF/PMP Pool	1.4	2.00	2.05
Rapid Drawdown from Normal Pool	1.3	1.73	N/A
Rapid Drawdown from PMF/PMP Pool	1.1	1.77	N/A
Typical Cross Section C			
Steady State Seepage with Normal Pool	1.5	1.91	2.07
Steady State Seepage with PMF/PMP Pool	1.4	1.97	2.07
Rapid Drawdown from Normal Pool	1.3	1.82	N/A
Rapid Drawdown from PMF/PMP Pool	1.1	1.79	N/A
Typical Cross Section D (Divider Dam)			
Steady State Seepage with Normal Pool	1.5	1.98	1.83
Steady State Seepage with PMF/PMP Pool	1.4	2.03	1.79
Rapid Drawdown from Normal Pool	1.3	1.73	N/A
Rapid Drawdown from PMF/PMP Pool	1.1	1.71	N/A

A.8.9 Perimeter Canal Stability

An analysis was performed to show the stability of the perimeter canal slope for section A, which showed the highest exit gradient in seepage models. The results showed a normal pool factor of safety equal to 1.53 and reduced slightly for the PMP condition to 1.49. **Figure A.8-3** shows the Normal Pool results for this analysis.

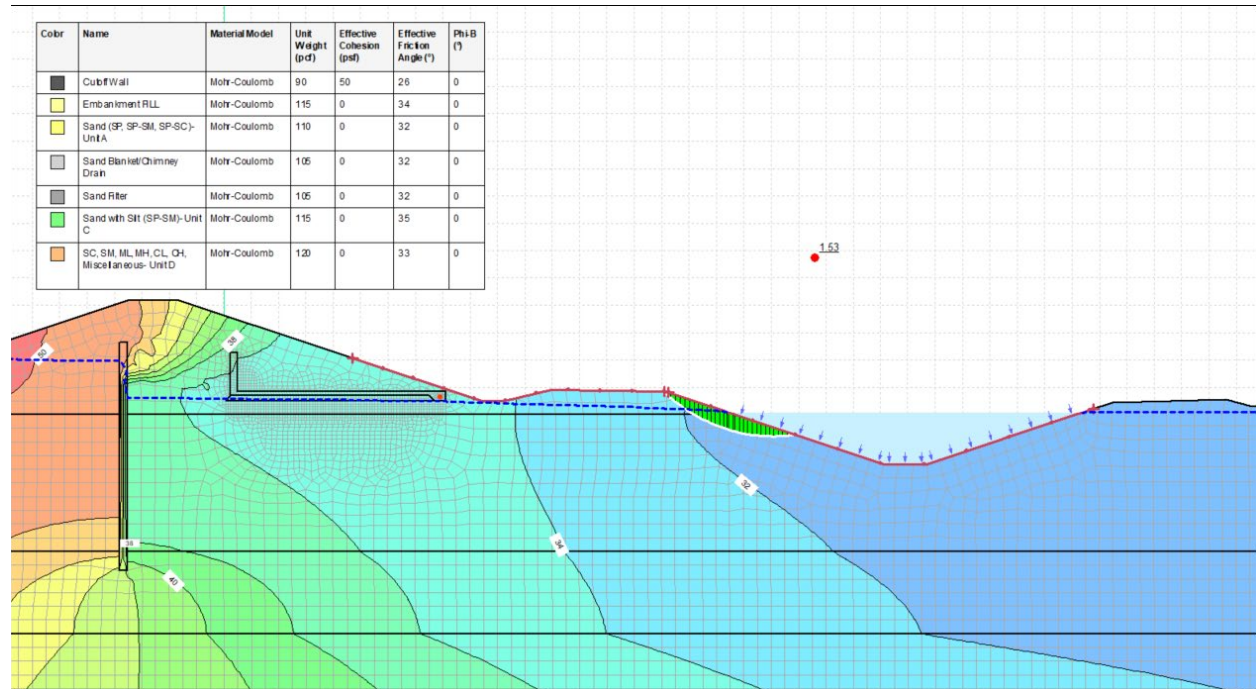

Figure A.8-3. Typical Section A – Perimeter Dam and Perimeter Canal.

A.8.10 Sensitivity Analyses

A.8.10.1 Reservoir Pool and Embankment Elevation

A sensitivity analysis was performed on a previous version of the embankment geometry to evaluate the effects of changing the upstream pool elevation and the top of embankment elevation. The upstream pool was analyzed for a normal condition of Elevation +51.7 ft NAVD88 as well as +/- 4-ft, +/- 2-ft, and +/- 1-foot from the normal pool. Additionally, the embankment height was varied +/- 2-ft from the top of embankment design of elevation +66.4 ft NAVD88. **Table A.8-5** shows the results of the sensitivity analysis for modified embankment crest and reservoir pool.

Table A.8-5. Sensitivity Analysis for Variation of Embankment Crest and Pool Elevation

[Embankment Elevation = 64.4 ft NAVD88 (-2' from Prior Design)]							
Pool Elevation (ft NAVD88)	-4 (47.7)	-2 (49.7)	-1 (50.7)	51.7	+1 (52.7)	+2 (53.7)	+4 (55.7)
Exit Gradient (critical)	0.13	0.14	0.15	0.16	0.16	0.17	0.18
Gradient F.S.	5.8	5.3	5.1	4.8	4.6	4.5	4.1
% Change from Original	18%	7%	3%	-2%	-6%	-9%	-16%
Embankment Stability FS (DS)	2.06	2.05	2.03	2.02	2.01	1.98	
Embankment Elevation = 66.4 ft NAVD88 (Prior Design)							
Pool Elevation (ft NAVD88)	-4 (47.7)	-2 (49.7)	-1 (50.7)	51.7	+1 (52.7)	+2 (53.7)	+4 (55.7)
Exit Gradient (critical)	0.13	0.14	0.15	0.15	0.16	0.17	0.18
Gradient F.S.	5.9	5.4	5.2	4.9	4.8	4.6	4.2
% Change from Original	20%	9%	5%	--	-4%	-8%	-14%
Embankment Stability FS (DS)	2.05	2.05	2.03	2.02	2.01	1.99	1.94

Embankment Elevation = 68.4 ft NAVD88 (+2' from Prior Design)							
Pool Elevation (ft NAVD88)	-4 (47.7)	-2 (49.7)	-1 (50.7)	51.7	+1 (52.7)	+2 (53.7)	+4 (55.7)
Exit Gradient (critical)	0.13	0.15	0.15	0.16	0.17	0.17	0.19
Gradient F.S.	5.8	5.2	5.0	4.8	4.6	4.4	4.1
% Change from Original	17%	5%	1%	-3%	-7%	-11%	-18%
Embankment Stability FS (DS)	2.05	2.04	2.03	2.02	2.01	1.98	1.94

NOTE: Red values indicate less desirable condition

Critical Gradient = 0.76

In general, the factor of safety against global stability changed by less than three percent for all scenarios analyzed. The seepage model showed the greatest change when the pool was raised by 4-ft, but the factor of safety remained acceptable for all conditions.

Due to the fluid nature of the feasibility study, the embankment crest elevation was changed following these original sensitivity runs. These results were not modified with the change, but the relative change depicted is expected to be similar with the revised geometry.

A.8.10.2 Perimeter Canal Surface, Wall Depth, Soil Profile Material Properties

Additional analyses were performed on Cross-Section A to analyze the sensitivity of the model to specific parameters. The results of these analyses are presented in **Table A.8-6**.

Table A.8-6. Sensitivity Analyses for Canal Surface, Wall Depth, and Materials, Cross-Section A.

Perimeter Canal Surface (N = EL. 31 ft)	Variation from Normal Condition, "N"				
	-3	-1	N	+1	+3
Exit Gradient	0.12	0.30	0.27	0.26	0.17
Gradient F.S.	6.1	2.5	2.8	3.0	4.5
Gradient F.S. Change	116%	-10%	--	4%	58%
Embankment Stability FS (DS)	2.1	2.1	2.1	2.0	1.9
Perimeter Canal Slope Stability FS	1.5	1.5	1.5	1.6	1.6
Wall Depth (N = 60 ft)	-	N	-10	-20	-30
Exit Gradient	-	0.27	0.34	0.40	0.45
Gradient F.S.	-	2.8	2.2	1.9	1.7
Gradient F.S. Change	-	--	-21%	-33%	-41%
Embankment Stability FS (DS)	-	2.1	2.0	1.8	1.8
Perimeter Canal Slope Stability FS	-	1.5	1.5	1.4	1.4
Material Variation - All Units	Kh*10	Kh/10	N	Kh/Kv = 1	Kh/Kv * 2
Exit Gradient	0.29	0.18	0.27	0.39	0.19
Gradient F.S.	2.6	4.3	2.8	1.9	3.9
Gradient F.S. Change	-7%	51%	--	-32%	39%
Embankment Stability FS (DS)	2.1	2.0	2.1	1.9	2.1
Perimeter Canal Slope Stability FS	1.5	1.5	1.5	1.5	1.6
Material Variation - Unit A	Kh*10	Kh/10	N	Kh/Kv = 1	Kh/Kv * 2
Exit Gradient	0.06	0.38	0.27	0.31	0.22
Gradient F.S.	12.5	2.0	2.8	2.5	3.5
Gradient F.S. Change	339%	-29%	--	-13%	24%
Embankment Stability FS (DS)	2.1	1.8	2.1	2.1	2.1
Perimeter Canal Slope Stability FS	1.7	1.3	1.5	1.6	1.5

	Variation from Normal Condition, "N"				
Material Variation - Unit B	Unit B not used in Model				
	-	-	-	-	-
Material Variation - Unit C	Kh*10	Kh/10	N	Kh/Kv = 1	Kh/Kv * 2
Exit Gradient	0.56	0.07	0.27	0.32	0.23
Gradient F.S.	1.4	10.2	2.8	2.4	3.2
Gradient F.S. Change	-52%	261%	--	-15%	15%
Embankment Stability FS (DS)	1.8	2.1	2.1	2.0	2.1
Perimeter Canal Slope Stability FS	1.3	1.7	1.5	1.5	1.6
Material Variation - Unit D	Kh*10	Kh/10	N	Kh/Kv = 1	Kh/Kv * 2
Exit Gradient	0.33	0.26	0.27	0.27	0.27
Gradient F.S.	2.3	2.9	2.8	2.8	2.9
Gradient F.S. Change	-18%	3%	--	-1%	1%
Embankment Stability FS (DS)	2.0	2.1	2.1	2.1	2.1
Perimeter Canal Slope Stability FS	1.5	1.5	1.5	1.5	1.5

NOTE: Red values indicate less desirable condition

Critical Gradient = 0.76

These results highlight the potential sensitivity to exit gradients previously described in **Section A.8.7.2**, and a suggestion for further consideration is provided in the recommendation section of this report.

A.8.11 Erosion Protection

A.8.11.1 General

A variety of alternative wave protection systems are used in reservoir and coastal engineering schemes including riprap, concrete slabs, concrete blocks, RCC, soil cement protection liners, bitumen systems, and various shapes of precast concrete blocks. Typically, the lowest cost protection is provided by using onsite materials if they are suitable. The conceptual design cross sections selected for use in the seepage and stability analyses for this preliminary study of the proposed LOCAR embankments incorporate soil cement as upstream slope protection and wave protection.

A.8.11.2 Soil Cement

Soil cement is considered an appropriate means of erosion protection for the LOCAR embankments given the availability of onsite aggregate. The soil cement slope protection system would be installed on a 3H:1V slope at a thickness of 12 inches. A control joint designed to accommodate shrinkage and control of irregular crack development (probably some type of lap joint configuration) should be considered at the top of the slope placement. A drainage layer should be provided beneath the soil cement to remove water from behind the system during drawdown of the reservoir level.

A.8.12 Foundations

When the embankment crosses local features, such as the existing irrigation canals, special cleaning, removal of organics, and backfill will be required to avoid differential movement. Foundation-bearing capacity is not a significant consideration for the conceptual embankment cross section at this site.

A.8.13 Settlement

A.8.13.1 Foundation Settlement

Relatively compressible material such as significant layers of soft clay or organic laden layers near the existing ground surface were not identified during the geotechnical exploration. However, it may be present in areas of the site which are often underwater. If present, this layer will be removed from the foundation prior to LOCAR dam embankment construction. Subsurface materials beneath the foundation layer are expected to deform elastically with minimal long-term residual movement under the stress of an embankment. At this time, it is not considered necessary to make allowance in the embankment height for settlement of the foundation. It is expected that most of the settlement caused by the embankment's weight will occur relatively fast and should occur during the construction of the embankments and the initial 30 to 60 days after the embankment materials are placed.

A.8.14 Borrow

A.8.14.1 General

Based on the field geotechnical explorations performed within the LOCAR site, material resources to support construction of the earthen embankment and soil cement revetment (excluding cement and additives) are expected to be available on site. However, a more detailed field exploration must be performed within the LOCAR site during engineering design to further define the borrow materials.

A.8.14.2 Embankment Fill

The embankment materials will consist of fill materials from the upper surficial soils and sandy material approximately 2 to 10 ft below the existing ground surface. These materials consist of sandy soils with silt and clay with no more than 20 percent fines from the total volume.

Random Fill

Material for the random fill can be obtained from the layer of surficial soils and sandy layers existing immediately below the surface soils. Rock and rock excavation is not expected. Local, isolated cemented sand (hardpan) areas are also not expected but are not uncommon in this area of Florida. If encountered, blasting is not required for these cemented layers and once material is broken it can be used for fill material.

The random fill will be hauled to the embankment location and stockpiled either on the interior bench between the embankment and the internal borrow area or in the location of its final placement in the embankment.

Drainage Fill

On-site Clean Sand (< 5% fines) can be mined and stockpiled onsite for use in Clean Sand drainage applications.

While filter quality fill might be obtained locally and from cleaner sand layers encountered in potential borrow areas, this material may require significant processing. Importing from local sources may be the most efficient method to obtain FDOT Filter Sand.

Soil Cement Revetment

Soil cement will be obtained from a Project-central batching plant by mixing onsite borrowed material and cementitious additives. Typically, a combination of cement, pozzolans mixture, water, and granular

soil will blend in a designed proportioned mix to obtain a homogeneous material, which can be placed and compacted with conventional earth-moving equipment.

Topsoil

In accordance with SFWMD design standards, a layer of topsoil is to be added to the exterior face of an embankment prior to seeding. Common practice is that topsoil material is obtained from the local organic soils and surficial material, and on the Project site it is expected to be available from the material removed from the embankment construction area. This material can be stockpiled near the location of the exterior toe of the embankment to reduce handling and cost.

A.8.15 Embankment Sections Evaluation

The evaluation of the conceptual embankment sections is discussed below.

A.8.15.1 Typical Dam Embankment Sections

An embankment of compacted sand, sand with silt, silty sand, soil bentonite cutoff wall, and chimney drain was evaluated for the LOCAR dam embankment. Typical cross sections were analyzed and are presented in **Figure A.8-2.A** through **Figure A.8-2.D** in **Annex B-2**. These sections were evaluated in the seepage and stability analyses. The embankment alternatives were developed to utilize materials expected to be obtained from the borrow excavations with minimum material sorting and processing. The embankment fill will consist of sandy soils such as sand, sand with silt, sand with clay, and silty sand. The processed soil bentonite cutoff wall consists of sandy soils mixed with bentonite to create a uniform mixture of materials to reduce seepage across the dam embankment and foundation materials. The chimney drain and drainage blanket are provided for internal drainage to protect against internal erosion of fines within the embankment fill and control the phreatic line in the downstream fill.

The horizontal drain extending at the toe of slope from the drainage blanket discharges into the perimeter ditch via the toe-drain piping system at the toe of embankment and then discharges to the perimeter canal.

Topsoil cover (using organic soil and surficial soils stripped from the embankment foundation) and grassing is assumed for erosion protection on the downstream slope. Upstream slope protection is provided by the soil cement revetment using flat-plate construction on the 3H:1V slope extending to the top of the embankment.

Foundation preparation for these conceptual design cross sections includes removing surficial organic soils. The soil-bentonite cutoff wall is assumed with an upstream offset of 9 ft from the centerline of the embankment (measured from the downstream face of the cutoff wall) and extending from elevation +56.4 ft to a minimum of 60 ft below the existing ground surface. The determination of depth for the cutoff wall was based on the assumed maximum depth of cutting of typical long reach excavation equipment.

A.8.16 Closing and Recommendations

The results of the 2D seepage model indicate the proposed design will perform acceptably. Analyses considered a soil bentonite seepage cutoff wall; a downstream foundation drain; and an upstream soil cement cover and drain—provides sufficient protection against seepage under steady-state and rapid-drawdown conditions. Similarly, the slope stability factors of safety using the assumed soil profile and material properties are also acceptable.

Available On-Site Materials

Based on the investigation and review of past geotechnical reports, it appears that sandy materials are acceptable for embankment construction and are readily available onsite. Lower permeability materials with higher fines content may be available for mining at deeper depths with some difficulty. However, the available sandy materials may also be blended with bentonite and fine-grained soils, as necessary, to reduce the hydraulic conductivity of these soils to be used as low-permeability barriers in combination with a multi-phased seepage cutoff wall.

Material with higher fines contents (clays) will be required for low permeability barriers. Examples of works proposed which require clayey materials include the “Select Fill Work Pad” connection between the lower and upper phases of the soil bentonite wall (SBW), the “Select Fill Plug” connection with structures that penetrate the embankment, “Clay Borrow” as needed to add fines to the SBW mixture, and the “Phase II Cap” to connect the upper portion of the SBW with embankment fill. Additional explorations are recommended within the reservoir footprint to mine for these more clayey materials, which seem to be more prominent to the north side of the reservoir compared to the south along the C-41A canal.

Settlement & Waiting Periods

Clay strata at depths less than 50-feet were isolated and generally of less than 5-foot thickness. Very Loose to loose clayey sand strata were present in the upper 50 feet and generally consisted of 12-30 percent fines with isolated layers up to 50 percent fines. Thicker layers of CH and higher fines (30-50 percent) SC were more prevalent below the depths of 40 to 50 feet, especially to the northern portion of the reservoir where the volume of embankment fill will be lower.

Supplemental borings were performed at the proposed locations of each structure, and additional borings would be recommended if structure locations are added, moved, or do not have available subsurface data. It is recommended that a detailed settlement analysis be performed during PED and proposed waiting periods be re-evaluated based on additional site investigations and the result of settlement analyses.

Soil Bentonite Wall

The results of the 2D model indicate a 60-foot depth cutoff wall will provide sufficient reduction in hydraulic gradient to permit reservoir construction. In future PED phases, the designer may consider optimizing the depth based on localized conditions within the reservoir. For example, more clayey materials were found toward the north side of the reservoir site and conditions toward the south along the C-41A Canal were generally sandier to greater depths. Additionally, ground elevations to the north are higher lending to lower head conditions within the reservoir to the North.

A system for collecting and testing permeability on relatively undisturbed samples of the SBW is recommended to supplement a testing program, which includes more frequent tests of backfill fines content and remolded permeability testing. A fixed piston sampler and a driller with experience using the device has been used successfully to consistently collect near-100-percent recovery samples of the soft SBW backfill.

Specification should emphasize the importance of mix homogeneity and limit the inclusion of clay balls that will skew the results toward unrealistically high fines contents. It is recommended to include removal

of clay balls greater than a specified size (Recommend 0.5 to 1-inches) prior to performing all laboratory testing per ASTM standards. This removal will better represent the behavior of the SBW “matrix” as opposed to clay balls with highly concentrated fines. Note, the Standard Test for Hydraulic Conductivity, ASTM D5084, recommends removal of clods and individual particles that exceed 1/6 of the height or diameter of specimens, which is generally 3 inches for the width of a specimen for hydraulic conductivity.

At the C-43 Reservoir, mixed SB Wall backfill material was introduced using two different methods – the “Mud Wave Method” and the “Bucket Method.” It is encouraged to specify that the SB Wall contractor perform backfill using the Bucket Method. The Mud Wave Method uses a bulldozer to pull material into the trench, while the Bucket Method sets the material at the top of the trench from a distance. Visual observations have shown it is difficult to avoid damage resulting from the dozer backing across the edge of the trench using the Mud Wave Method, even for skilled operators.

See discussion about the construction and testing of the soil bentonite wall for the C-43 Reservoir and its relevance to the LOCAR project in the Lake Okeechobee Component A Reservoir Screening Level Risk Assessment report, by the Corps, Jacksonville District, dated February 12, 2024 (see recommendation No. 21 in this risk assessment report).

Seepage Exit Gradients and Downstream Canal Treatment Considerations

The seepage models suggest some exit gradient sensitivity based on the material profile at the perimeter canal. This profile is likely to vary across the site, and it may be prudent to consider designing to avoid surficial sloughing resulting from high exit gradients. Additional modelling and consideration should be given to this matter during the PED phase. Potential design features may include a filtered exit or less steep slope near the seepage exit location along the perimeter canal.

The potential for seepage issues is also increased around concave corners of the reservoir perimeter dam due to converging seepage vectors caused by the geometry of the horizontal curve at each of these corners. During the PED phase of the Project, design consideration should be given to adding a filtered seepage exit with revetment along the exterior side slope and toe ditch of the perimeter dam at these locations; and special oversight and attention should be afforded to these key locations during construction.

Weather

Florida weather patterns should be a significant consideration during construction. Frequent heavy rainfall should be expected during the wet season, making handling of materials with higher sensitivity such as clays more difficult. Unexpected heavy rains may also occur during the “dry” months. Standpipe piezometers (PZ-1 to -6) were installed for the 2023 investigation by Ardaman for this report. It is recommended to collect regular readings for historical data during PED. These instruments should also be identified and grouted during construction prior to filling the reservoir.

A.9 Reservoir Seepage

A.9.1 Introduction

This section describes the methods for quantifying and managing the anticipated seepage losses from LOCAR proposed under the Recommended Plan. The reservoir site, which includes the reservoir and its external features, including its perimeter canal, perimeter maintenance road, east inflow-outflow canal, and west inflow-outflow canal, would encompass an area of approximately 12,554 ac outside of the C-41A right-of-way, of which the reservoir would occupy an area (within the centerline of its perimeter dam) of approximately 11,320 ac. At its NFSL of 51.7 ft NAVD88, the reservoir would have an average storage depth of approximately 18 ft within each of its two storage cells since the average ground surface elevation within the storage cells is 33.9 ft NAVD88. As shown in **Table A.11-1**, the reservoir's above-ground storage capacity is approximately 205,710 ac-ft at its NFSL of 51.7 ft NAVD88. The reservoir is located in the C-41A Basin, just north of the C-41A canal and east of the S-83 gated spillway and northwest of the S-84 gated spillway. Topography varies from around 40 ft NAVD88 on the northern side of the reservoir to around 27 ft NAVD88 on the southern side. Surrounding lands consists mostly of mixed agricultural uses. Major roads near the Project site include State Road 70 and County Road 721.

Three-dimensional (3D) MODFLOW groundwater modeling was performed to estimate seepage from the reservoir. The groundwater model was used to evaluate the following seepage impacts:

- The amount of flow from the reservoir due to seepage,
- The amount of flow that is collected by the seepage management canal (i.e., the Project perimeter canal),
- The effectiveness of various seepage control elevations in the perimeter canal,
- The amount of unrecoverable seepage, if any, that migrates to surrounding areas, and
- The effect of any unrecoverable seepage on groundwater levels in the surrounding areas.

A.9.2 3D Groundwater Model Development

The 3D groundwater model development included the following major components described below:

1. Model Area
2. Surficial Aquifer Material Units and Parameters
3. Model Numerical Discretization
4. With and Without Project Model Inputs

A.9.2.1 Model Area

To assess seepage impacts of the reservoir and avoid the influence of boundary effects, the model boundary was extended several miles outside the reservoir on all sides. The model outer boundary coincides with existing waterbodies that surround a several-mile buffer area. The model area is shown in **Figure A.9-1**. The northwest and northern boundary of the model is along the southern side of Lake Istokpoga, the Istokpoga Canal and the Kissimmee River, the eastern boundary is along the Kissimmee River/C-38 Canal, the western boundary is along the C-41 Canal, and the southern boundary is along the L-48 and L-49 Canals just northwest of Lake Okeechobee.

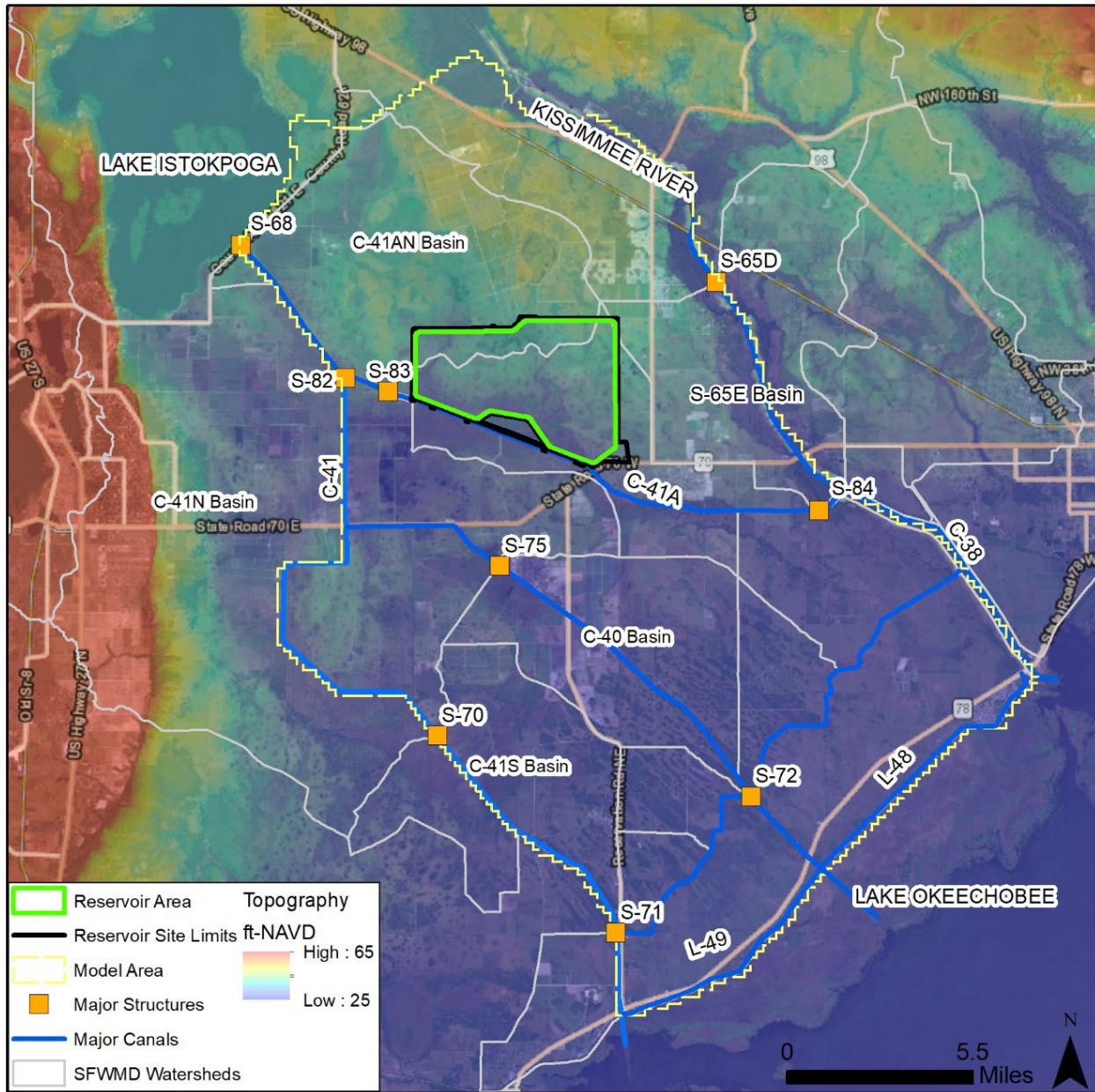

Figure A.9-1. 3D groundwater model area.

Figure A.9-2 shows a closer view of the project site and the adjacent properties and owners. The area on the west side of the reservoir site is occupied by the Ru Mar, Inc. and is mostly improved and unimproved pasture lands with some wetland areas. The north side of the reservoir site is mostly occupied by the Lykes Brothers, Inc. Basinger Tract Basin 4. This area is a mixture of wetland areas and citrus crops with a system of above ground impoundments (AGIs) that collect runoff from the citrus fields. From the northeast corner to the southeast corner, various owners and mixed used farms (citrus, row crops and pasture with some wetland areas and irrigation reservoirs) occupy the lands adjacent to the reservoir site. South of the reservoir site is the Brighton Valley Impoundment, which is a Dispersed Water Management project managed by the Lykes Brothers, Inc. On the southeast corner, the LOCAR design plans show a temporary construction office and staging area which is drawn as part of the project site. Note that this area may be

returned to the landowners after LOCAR construction completion. A dash line along this area marks the project site after construction.

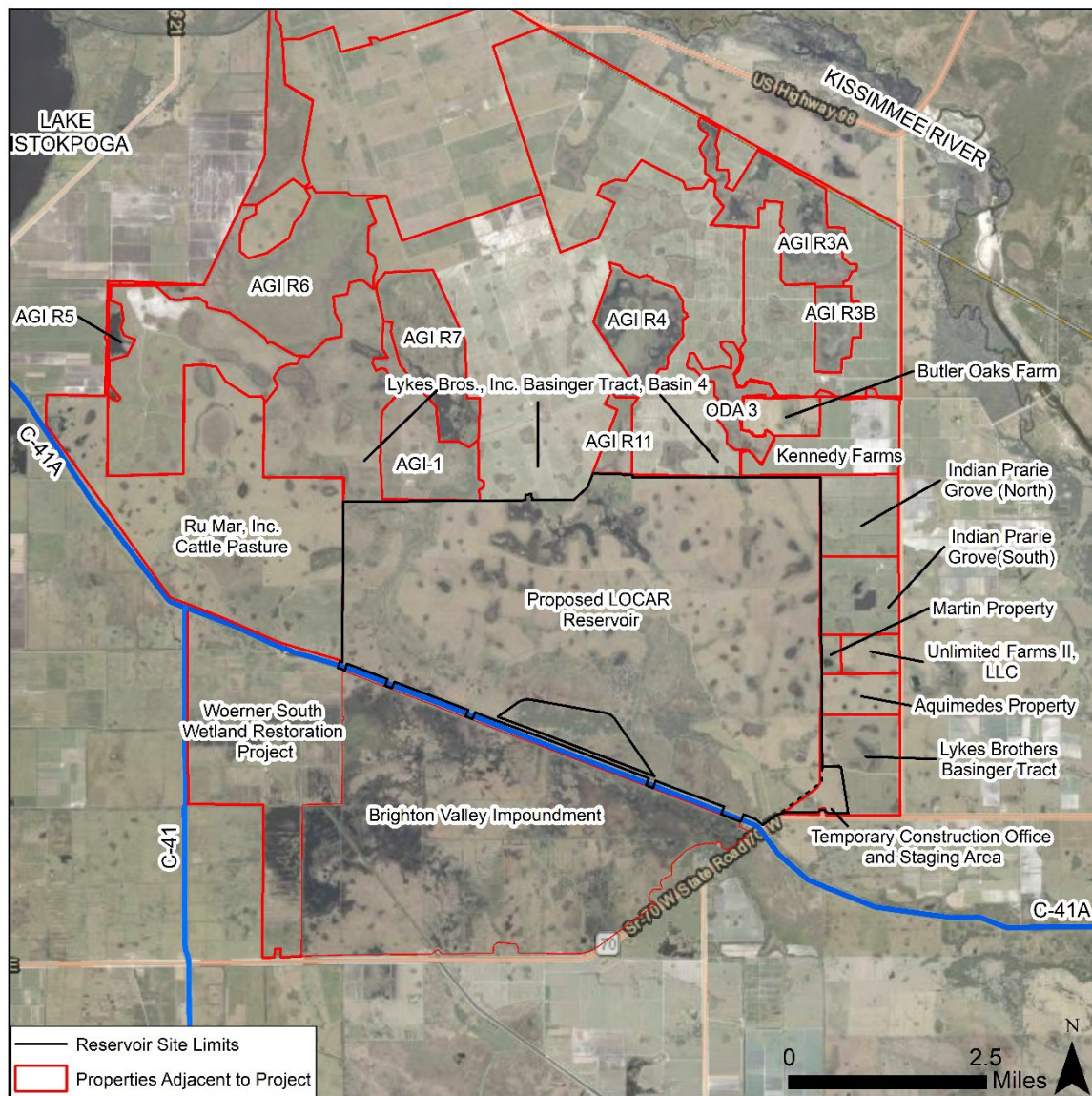

Figure A.9-2. Project area and adjacent lands.

A.9.2.2 Surficial Aquifer Material Units and Parameters

The hydrogeological parameters and layers that define the 3D groundwater model developed herein were based on 8 borings around the perimeter of the reservoir collected during the initial exploration phase of this project and interpreted by the project geotechnical engineers to develop a conceptual multi-unit geological model of the surficial aquifer. The interpretation process consisted of grouping the numerous types of materials, that were collected in each boring and previously tested, into four vertical units listed in **Table A.9-1**. The assigned hydraulic conductivities and anisotropy ratios were estimated based on on-site testing (including DRI and slug testing) performed by Ardaman (2011), the Corps (2007), and industry standard values. More information about the materials and properties is provided in **Appendix A, Section A.7** and **Section A.8**. It should be noted that the boring data is complex and difficult to generalize. The

permeabilities that were assigned for each unit were adjusted in each location to represent the presence of the various materials found at those specific locations. Typical conductivity values and the average unit thicknesses are shown in **Table A.9-1**. The data provided by the geotechnical team included the elevations of each generalized unit, if present in the boring, and corresponding horizontal and vertical conductivities for each of the borings. It should be reiterated that the actual stratigraphic layering is complicated and may need to be revised in the PED phase, based on the findings from additional borings performed at the reservoir site during the PED phase. While the borings were generalized to four “Units” as shown in **Table A.9-1**, these should not be considered a continuous stratigraphic unit connected across the site.

Table A.9-1. Interpreted Hydrogeologic Units from Boring Materials.

Unit	Materials ¹	Kh (cm/sec)			Kh (ft/d)			Kh/Kv	Thickness (ft)			Number of borings present
		Mode ²	Max	Min	Mode	Max	Min		Average	Max	Min	
A	SP, SP-SM, SP-SC	1.0E-02	1.0E-02	1.0E-02	28.3	28.3	28.3	5	37	60	23	8
B	SM, SC, (with SP)	1.0E-03	1.0E-03	5.0E-04	2.8	2.8	1.4	10	21	44	10	8
C ³	SP-SM	1.0E-03	5.0E-03	5.0E-04	2.8	14.2	1.4	10	35	59	25	4
D	SC, SM, ML, MH, CL, CH	5.0E-04	5.0E-04	8.0E-04	1.4	2.3	1.4	10	27 ⁴	50	13	5

¹ See **Appendix A, Section A.7** and **Section A.8** for definitions of material descriptions and associated parameters.

² Most frequent value assigned to the 8 boring locations before interpolation into surfaces.

³ The permeabilities assigned to the unit vary up to an order of magnitude. The thicknesses shown are the average thickness in the boring data. In locations where the unit is not found, a small thickness of 0.25 feet was applied with parameters of Unit B.

⁴ Thickness of Unit D depends on on the depth of the the wells.

The conductivities shown above are within the range of previous studies of the area. For example, the horizontal conductivities that were calibrated for the surficial aquifer in the Lower Kissimmee Basin Groundwater Model (Butler et al., 2014) range from 1.8 to 115 feet/day within the LOCAR groundwater model area. Thus, the LOCAR horizontal conductivities are mostly within the range calibrated for the 2014 study, except for Unit D, which falls just below the low range (1.4 feet/day). Another study by the USGS (Sepúlveda et al., 2012) developed a regional MODFLOW model for East-Central Florida, which includes the northern areas of Highlands County. The calibrated hydraulic conductivities for the areas near the Kissimmee River in Highlands County for the surficial aquifer ranged from 20 to 30 feet/day.

These parameters were extrapolated into surfaces for model input using an inverse distance weighted average with the exponent distance of 2. This method ensures that the data at the boring location is well maintained, as opposed to other interpolation methods that would smooth out the data based on other locations, and thus maintaining the observed differences in the various portions of the reservoir embankment. Maps of the interpolated parameters are shown in **Figure A.9-3** to **Figure A.9-8**. A figure for the Unit D bottom elevation is not included because the boring data collected is shallower than the estimated average bottom elevation of the surficial aquifer (as shown on the design plans). The bottom elevation of the model is assumed to be a uniform value (-120 ft NAVD88). A figure for the Unit A conductivities is not included because all locations were assigned a uniform value of 28.35 ft/d.

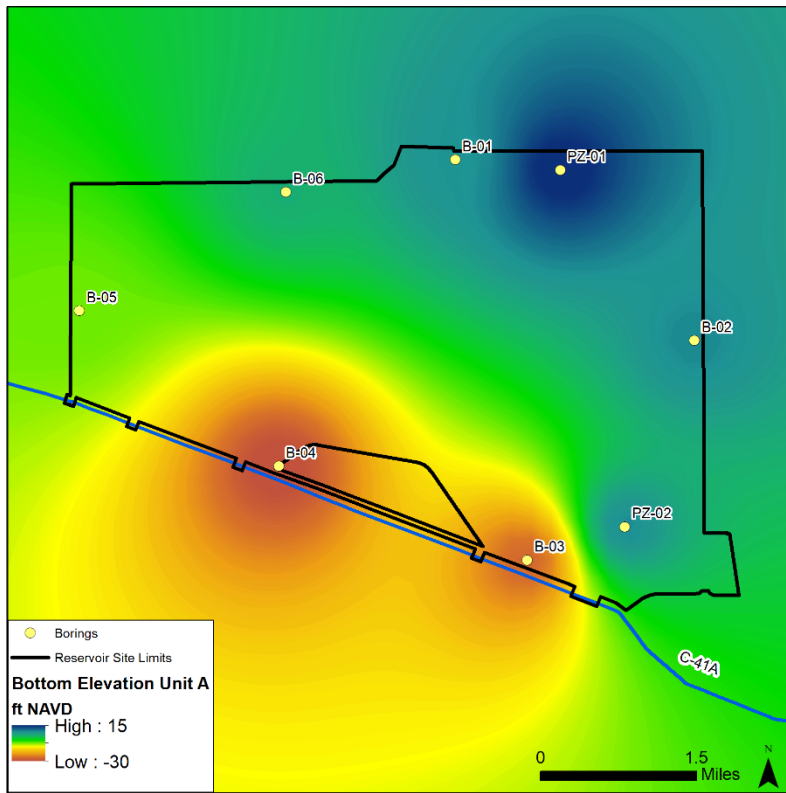

Figure A.9-3. Unit A bottom elevation.

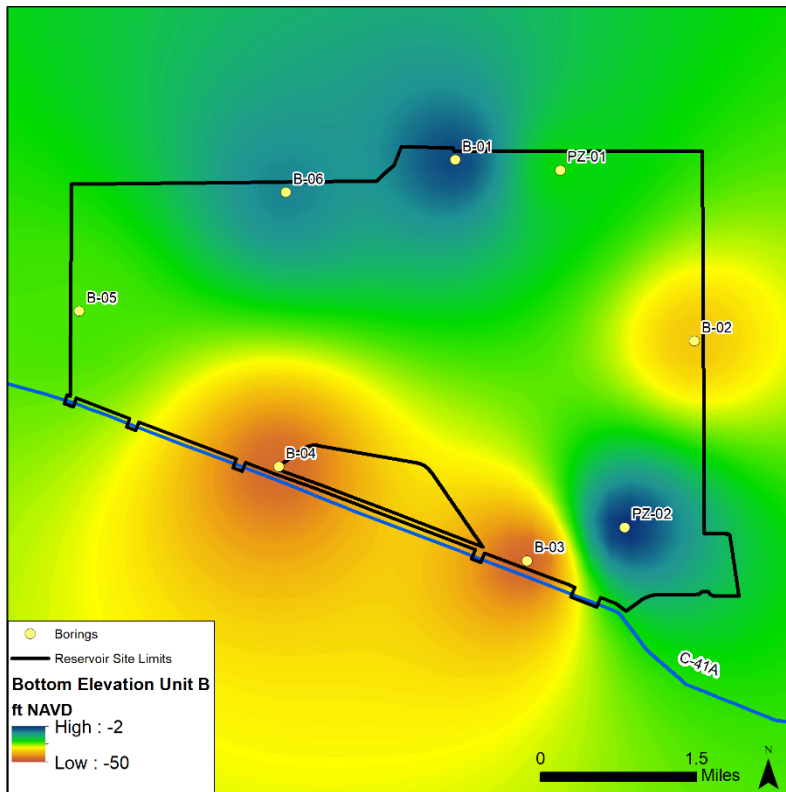

Figure A.9-4. Unit B bottom elevation.

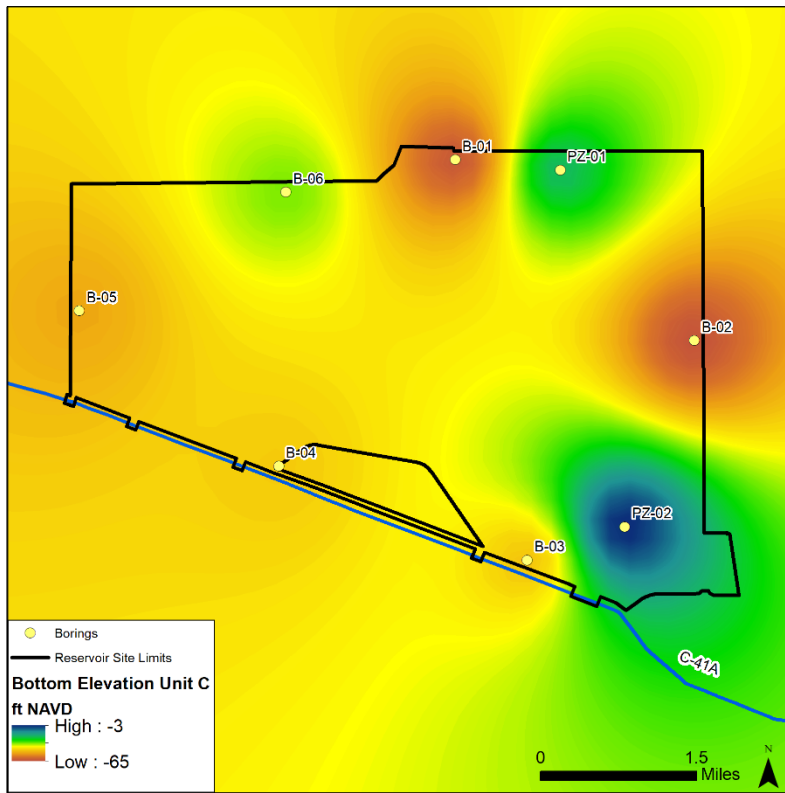

Figure A.9-5. Unit C bottom elevation.

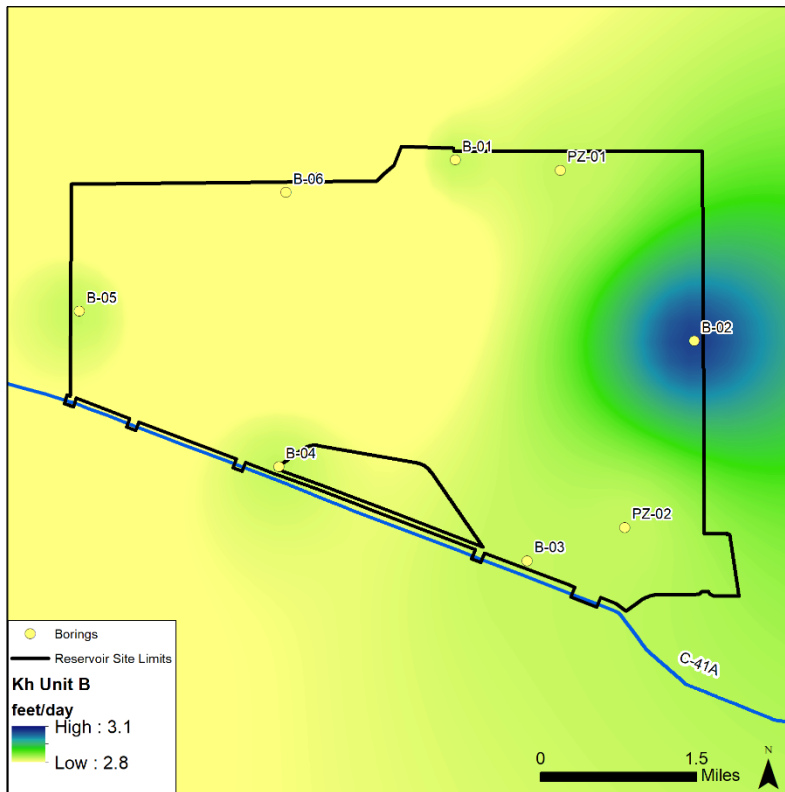

Figure A.9-6. Unit B horizontal hydraulic conductivities.

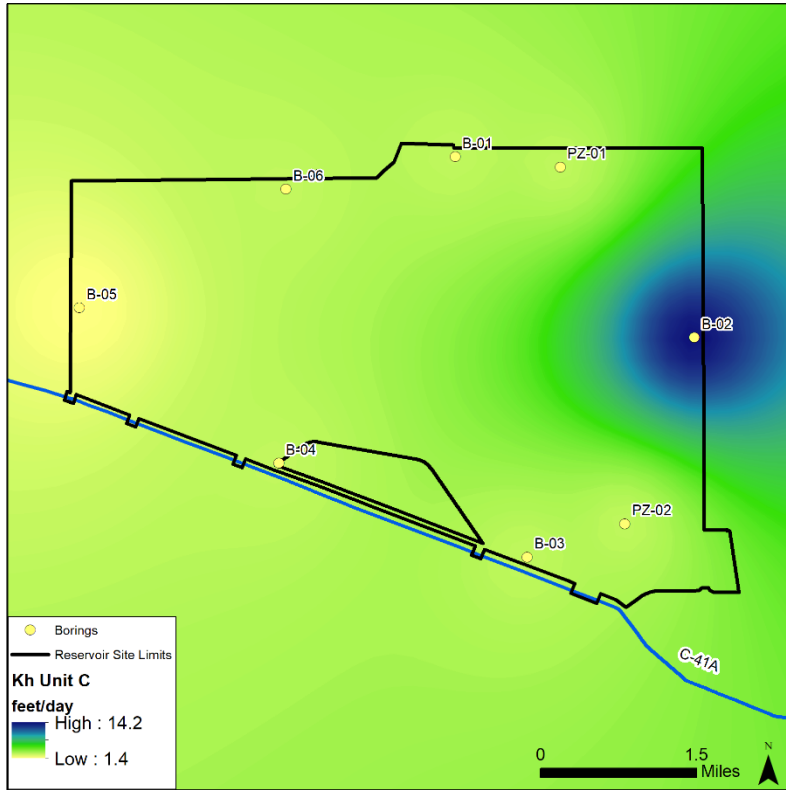

Figure A.9-7. Unit C horizontal hydraulic conductivities.

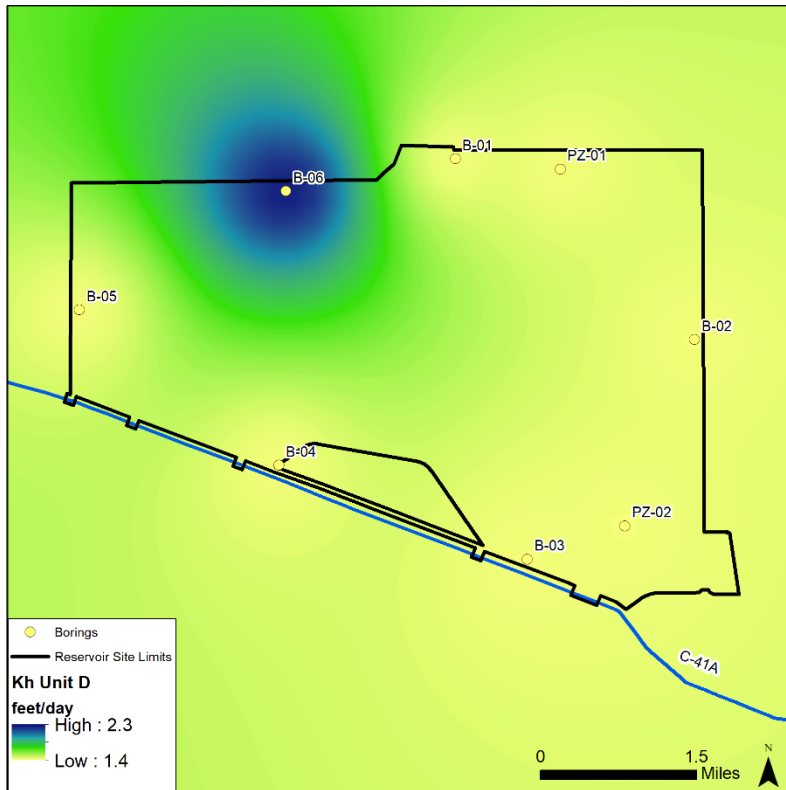

Figure A.9-8. Unit D horizontal hydraulic conductivities.

A.9.2.3 Model Numerical Discretization

Horizontal Grid

The numerical model used is the MODFLOW 2005 structured finite difference grid with variable cell sizes. The larger grid cells furthest from the project features are 1,000 feet x 1,000 feet. The finer project features, such as embankments, canals, and cutoff walls are represented with smaller cells sizes, according to the shape, predominant flow direction, and relative distances between the features. The smallest grid cell sides are 18.8 feet in the x- (east-west) direction and 18.0 feet in the y- (north-south) direction. This variable grid approach has the advantage of capturing the fine features details where it is most critical for the purposes of the reservoir seepage analysis while maintaining a feasible number of computational nodes. Grid smoothing was applied with a maximum grid change ratio of 1.5 for the transition between adjacent rows and columns. The horizontal grid development resulted in a total of 116,745 active cells for each model layer. **Figure A.9-9** shows the model grid zoomed in to the entire reservoir and the southwest corner of the reservoir.

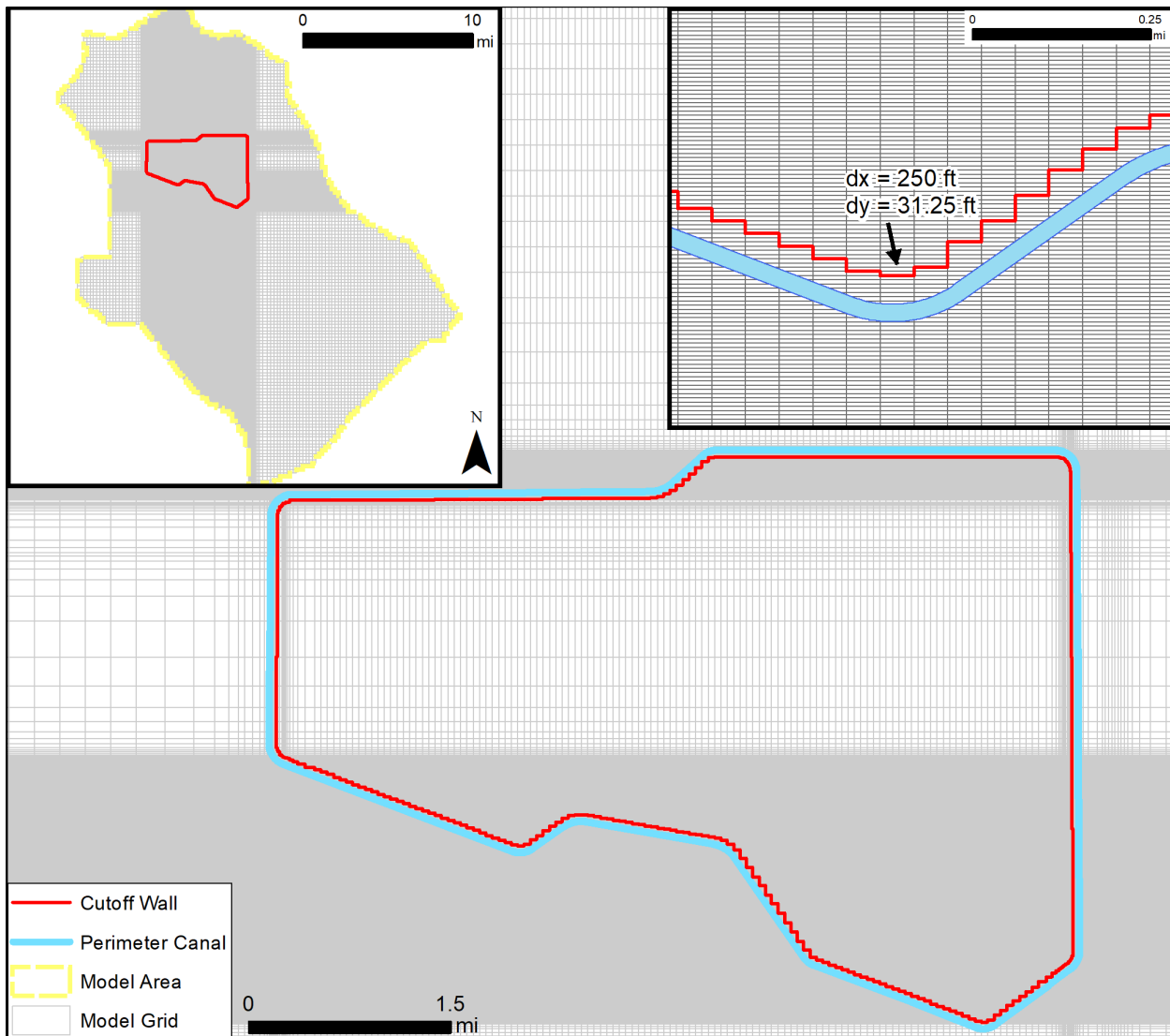

Figure A.9-9. 3D groundwater model grid with zoomed-in views near Project features.

Test of the 3D Model Horizontal Grid Resolution Adequacy with High Resolution 2D Models

Three 3D test models were developed approximating the 2D SEEP/W models presented in Section A.8.7.2. The purpose of this model comparison is to check that the 3D model resolution is adequate to accurately approximate the flow across the reservoir cutoff wall since the project design features can be simulated at a much higher resolution in the 2D cross section model. To make the comparison as equivalent as possible, the 3D models were set with the uniform layering used by the 2D cross section models and used fixed head boundaries for the canal and the reservoir with the same elevations. Thus, the 3D model parameters specified on the test models differ from the hydrogeologic model interpolations described above and the vertical layering described in the section below. For example, the 2D models do not have Unit B, and Unit C is assigned the highest permeability associated with this unit, which occurs in boring B-02 (**Figure A.9-7**). **Table A.9-2** shows the flow leaving the reservoir for the three embankments sections. The 2D model predicts slightly higher flow than the 3D model, which is expected due to the much finer detail along the direction of flow. The errors in flow per mile and in the flow per mile per foot of head difference range from 7 to 10 percent. Testing of smaller resolutions of the finite difference grid, as well as unstructured grids, was conducted but the resulting reductions in errors if any were relatively small, while losing efficiency in model input processing and running speeds. A difference of 0.4 cfs per mile for a total of 18.7 miles of the reservoir embankment results in a difference of 7.5 cfs, which is a relatively small error when it comes to seepage pump sizing. Thus, it was concluded that the horizontal grid resolution is adequate for estimating seepage flow.

Table A.9-2. Comparison of 2D and 3D models with similar parameters

Cross Section	Canal Stage	Head Differential (NFSL – Canal) (ft)	2D flow		3D flow	
			(cfs/mi)	(cfs/mi/head)	(cfs/mi)	(cfs/mi/head)
A	30.2	21.5	3.2	0.15	2.9	0.13
B	24.0	27.7	3.5	0.13	3.1	0.11
C	39.1	12.6	2.4	0.19	2.2	0.18

Vertical Grid

The four hydrogeological units described above were split into a seven-layer model to represent the varying bottom elevation of the reservoir cutoff wall. The cutoff wall in the design plans is 60 feet below ground in all the embankment cross sections. Due to the varying depths of the units and changes in elevation around the perimeter of the reservoir, the presence of the cutoff wall in each unit varies spatially and thus, the vertical discretization of the model was defined to account for these variations. The layers corresponding to each hydrogeologic unit are shown in **Table A.9-3**.

A vertical no flow boundary was specified at the bottom of the model (-120 ft NAVD88), which assumes that there is a large zone of confinement between the surficial aquifer and the Floridan aquifer. This assumption is supported by the boring data collected for the project site, which shows increasingly finer and lower permeability materials with increasing depth. The bottom elevation of the deepest well analyzed for the study area at an elevation of -113 feet-NAVD88. Other studies (Sepúlveda et al., 2012 and Butler et al., 2014) indicate that the intermediate confining unit is at least 100 feet or higher in Highland County. The bottom of the surficial aquifer and the no flow boundary assumption should be further refined as more data becomes available in the PED phase of the project.

Table A.9-3. 3D Groundwater Model Layers and Hydrogeological Units.

Layer	Conductivities of Unit	Layer Bottom elevation
1	A	Unit A bottom elevation
2	B	Cutoff wall bottom elevation if higher than Unit B bottom or avg. bottom of A and B
3	B	Unit B bottom elevation
4	C	Cutoff wall bottom elevation if higher than Unit C bottom or avg. bottom of B and C
5	C	Unit C bottom elevation
6	D	Cutoff wall bottom elevation if higher than Unit D bottom or avg. bottom of C and D
7	D	Uniform at assumed surficial aquifer bottom elevation = -120 ft NAVD88

A.9.2.4 Conceptualization of With and Without Project Models

With project and without project (or baseline) steady-state models were developed for comparing the impact of the project on the baseline water table. Given that the baseline water table is critical to seepage estimates and to bracket the seepage impact under varying conditions, a model representative of wet season conditions and a model representative of dry season conditions were developed. The section below describes the development of the baseline (without project) model for these two conditions.

It should be noted that these models were not calibrated due to limited data availability and project schedule time constraints. Moreover, the baseline model is not an existing conditions model because some of the transition areas surrounding the reservoir are treated assuming that they are in their planned condition, such as the Brighton Valley Dispersed Water Management (DWM) project, which is located south of the reservoir. Nevertheless, the simulated baseline water table for both wet and dry conditions was verified with available information, such as farm field control elevations and the available well data measurements. It should be noted that there is only one long-term active surficial aquifer monitoring well (HIS-1) near the project site located adjacent to the C-41 Canal, just south of S-82. The data for this well indicates that the water table depth fluctuates from around 6 to 5 feet below ground. But given the proximity of the well to the C-41 Canal, the water levels measured at this location may be influenced by the stages in the canal and may not be representative of water levels further away from large canals. In addition, as part of the field investigations of this study six piezometers were installed within the project footprint. Groundwater levels were obtained from these piezometers on May 30, August 14, and August 28, 2023. The groundwater levels from these dates were reviewed against the without Project model and the simulated groundwater levels were within range of the observed values.

Only one previous model that covers the project area was found, the Lower Kissimmee Basin Groundwater Model (Butler et al., 2014). However, this model is focused on the deeper Floridan aquifer, as it was developed in support of the SFWMD regional water supply plan, and it simulates the surficial aquifer as a single layer. The model report does not show the simulated water table in the surficial aquifer, but it indicates that the initial assumption for the depth of the water table is one foot below the ground. Thus, in the farm fields, the water table is assumed to be near the control elevations, as further described in the section below, and in unmanaged areas to vary from 1 to 6 feet below the ground, with some shallow ponding in wetland areas considered acceptable, particularly during the wet season. Once it was confirmed that the baseline models for wet and dry conditions were able to simulate a water table within this expected range, the project model was developed with the same parameters. Thus, the with and without project models are identical except for the added project features (to the with-project model).

A.9.2.4.1 3D Groundwater Model Inputs

Top Elevation

The top elevation of the model is the ground surface and is based on the Highlands County 2018 USGS LiDAR DEM, downloaded from the USGS Lidar Explorer Map (nationalmap.gov). The LiDAR elevations were averaged for each model cell. For the with-project model, the embankment height and perimeter canal bottom elevations were burned into the LiDAR and averaged for each model cell.

Recharge

Estimated seasonal recharge was added to the model based on average wet season and dry season rainfall and evapotranspiration (ET) for the period of 2018 to 2022, for the wet season months (June to October) and dry season months (November to May), respectively. Data measured at the DBHYDRO S-83_R was used to calculate these averages, shown in **Table A.9-4**. Note that the ET values on the table are the reference ET, which is converted to potential ET for the various land uses based on typical crop coefficients values, shown in **Table A.9-5**. The actual ET was then adjusted to avoid cells drying and allow for model convergence.

Table A.9-4. Calculated Seasonal Average Rainfall and Reference Evapotranspiration based on DBHYDRO data at S-83_R.

Hydrologic Component	Wet Season		Dry Season	
	Total (inches)	Average Rate (ft/d) ¹	Total (inches)	Average Rate (ft/d) ¹
Rainfall	29.4	0.0163	11.6	0.005
Reference ET ²	24.4	0.0136	29.7	0.012
Net Potential Recharge ³	5.0	0.0028	-18.1	-0.007

¹ Model input unit for recharge and ET.

² Converted to potential ET by multiplying for typical crop coefficient. Actual ET is further reduced based on water availability within the ET surface depth (or extinction depth = root zone + capillary zone).

³ For unadjusted Reference ET, the actual net recharge varies according to actual ET.

ET zones were spatially distributed according to land use type based on the SFWMD land use map (the SFWMD_Land_Cover_Land_Use_2017-2019 geodatabase) FLUCCS classifications. The distribution of zones was used to specify different ET potential and water management. In the wet season model, no irrigation is applied, and net recharge is calculated by the model based on the input rainfall and potential ET (PET). In the dry season model, the managed agricultural fields (ET zones 1-3) are assumed to be irrigated at the same rate as the PET, thus ET is assumed to be zero. Thus, crops get the water they need, and any excess water is removed by the drains, set at the control elevations described in the Boundary Conditions section below. For ET zones 4 and 5, no irrigation is applied, and the net recharge is negative. The ET zones are shown in **Table A.9-5** and **Figure A.9-10**.

Table A.9-5. Recharge/ET Zones and Crop Coefficients (Kc).

Zone	Land use	Wet Season Kc ⁴	Dry Season Kc ⁴	Irrigated in Dry Season
1	Non-citrus crops ¹	1	0.5	Yes
2	Citrus	0.85	0.5	Yes
3	Pastures with Irrigation Systems	1	0.4	Yes
4	Undeveloped or low development lands ²	1.05	0.9	No
5	Low Management Pastures ³	1	0.4	No

¹ Land use classifications: field crops, row crops, and sugar cane.

² Land use classifications: upland forests, wetlands, low density development (such as rural residential)

³ Pastures as classified in the land use map and areas with minor or low-density drainage as observed on aerial imagery.

⁴ Food and Agriculture Organization (1998)

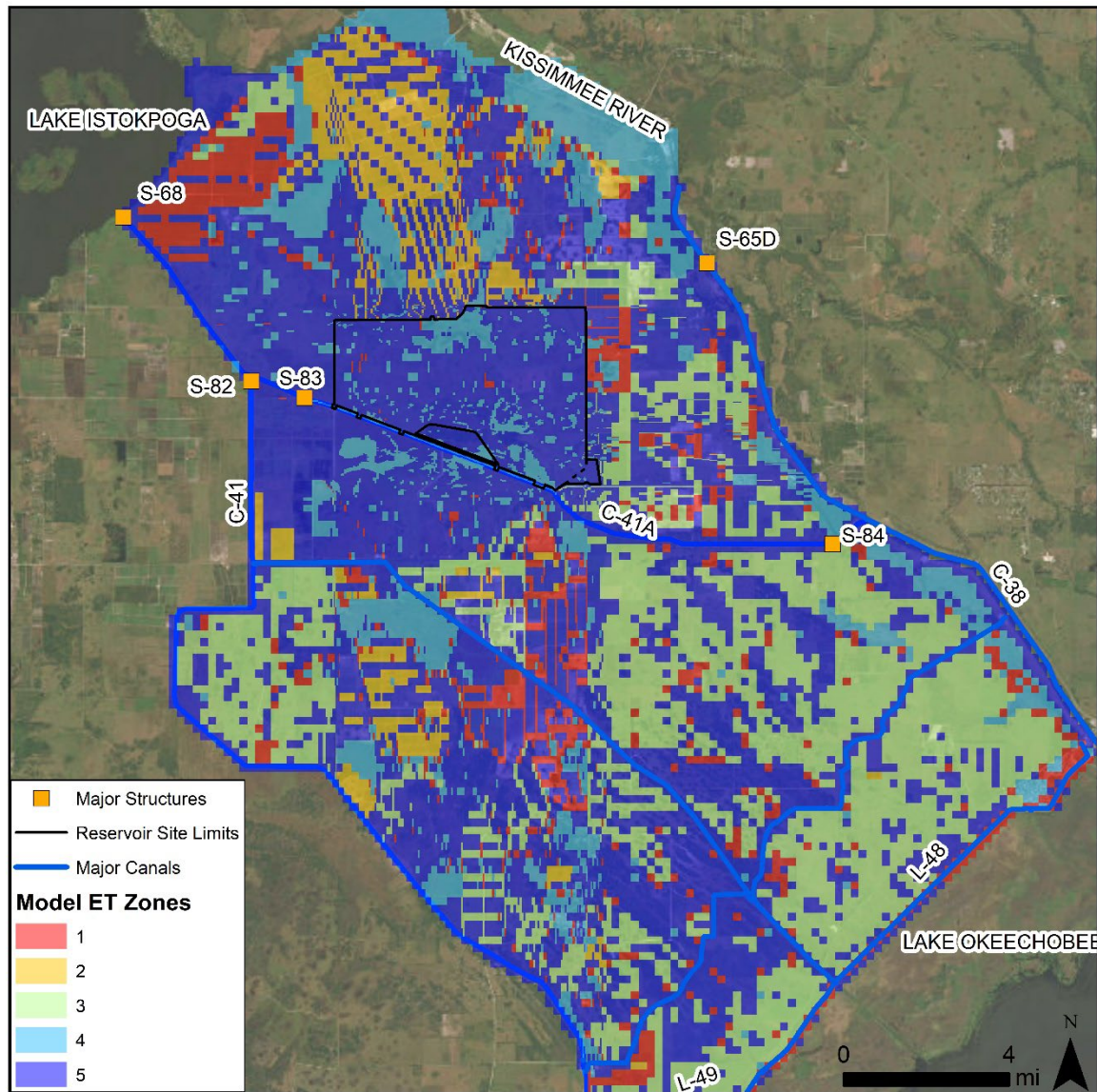

Figure A.9-10. ET zones.

Boundary Conditions

Three types of boundary conditions were used to define stages in canals and lakes, as listed and further described below. A conceptual schematic of the difference between the three types is presented in **Figure A.9-11**. The impact in the results for various conditions was tested and is shown in the sensitivity analysis section **A.9.3.4**.

1. Constant head boundaries (CHB) – These boundaries were used to represent the stages in the reservoir at the NFSL and for the Lake Istokpoga outer boundary.
2. River boundaries – These boundaries were used to represent the existing major canals and the project perimeter canal (a.k.a. the reservoir perimeter canal or CNL-1).

3. Drain boundaries – These boundaries were used to represent farm canals and drains to maintain the farm fields at the estimated control elevations.

Figure A.9-11 shows a schematic illustrating the difference between these boundary types. The top boxes show the cases where the specified boundary stages are lower than the aquifer; and the bottom boxes show the cases where the specified boundary stage is higher than the aquifer. Case 1 shows two aquifer cells (separated by the black line in the middle), on the left the cell does not have a boundary and the cell on the right has a CHB boundary. Cases 2 and 3 show a single aquifer cell with a river and drain boundary, respectively.

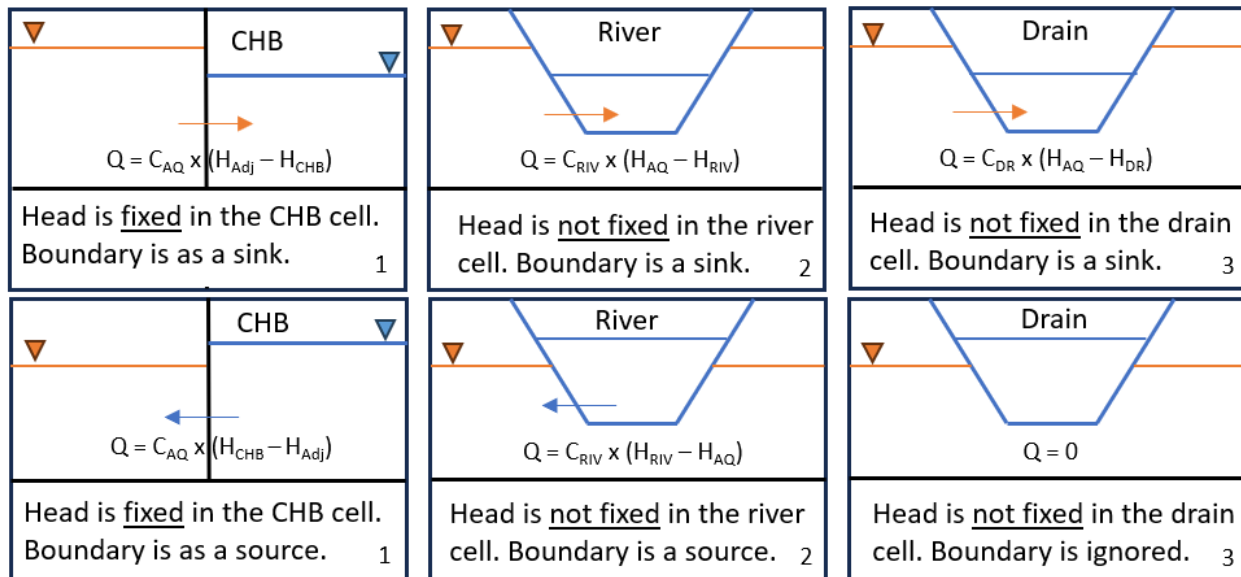

Figure A.9-11. Boundary conditions type schematic.

In case 1, CHB, the head is not calculated and the flow in and out of the cell does not change the fixed head in the cell. The cells act as a source or sink to adjacent aquifer cells water depending on the head differential between the cells. The conductance (C_{AQ}) is defined by the cell geometry (area of flow perpendicular to flow direction and length between the cell nodes along the flow direction) and the hydraulic conductivities between the cells. This type of boundary is appropriate for simulating known stages in water bodies where the vertical resistance between the water body and the aquifer is negligible and the exchange is dominated by the aquifer conductivity. Using this type of boundary for the reservoir is conservative because it minimizes the head losses due to vertical leakage and stage will not be impacted by evaporation losses or seepage. Thus, the fixed head boundary simulates the highest potential head differential between the reservoir and surrounding land, which is representative of the “worst-case” scenario for seepage impact.

In cases 2 and 3, the boundaries are head dependent sources or sinks within the aquifer cell. The heads are calculated in these cells, i.e., not fixed. The resulting heads depend on the flow balance in and out of the cell, which includes the flow to or from the boundary. When the aquifer level is higher than the specified stages in the river or drain boundaries, both types of boundaries act as a pump or a sink, removing the water from the model at a rate controlled by the conductance. The only difference between the river and the drain boundary is when the aquifer level is lower than the specified stage in the

boundary. In this condition, the river boundary contributes flow to the aquifer at a rate controlled by the conductance, whereas drains only remove flow from the model, i.e., they are not a source of flow. At this feasibility phase, limited information was available on how the farm fields are managed and thus using the drain boundaries for the farm areas is considered appropriate and more conservative than using river boundaries. It is more conservative because it avoids raising the water table in the farm fields due to the specified stages in the boundary. The higher the water table adjacent to the project, the lower is the seepage potential from the project due to the reduced head differential. For the farm canals, the stages are known. Thus, using a river boundary that can act as either a source or sink given the stage is appropriate. For the perimeter canal the river boundary is more conservative because in areas where the canal stage is higher than the adjacent water table, it can become a source of flow potentially contributing to flooding of those areas. Thus, in this case seepage to adjacent lands can be generated not only from the reservoir seepage outflow that bypasses the perimeter canal, but also from the perimeter canal acting as a source. In addition, the river boundary, similar to the drain boundary, can act as a pump by removing the volume of flow in the boundary cells that exceed the specified control elevation. A series of sensitivity analyses were done to test the effect of these types of boundaries given the baseline conditions assumed and some variations in those conditions. The assumptions for calculating the stages and conductances for these boundaries are discussed below.

Canal Stages

The stages specified for the existing primary canals are based on the DBHYDRO average stages for the months of June to October and for the months of December to April for the wet and dry season model, respectively, as measured during the period of 2018-2022. For the dry season, the months of November and May were intentionally excluded to reduce the effect of the potential transition periods from and to the wet season. The location of the major canal boundaries and the stages specified for the wet and dry season models are shown in **Figure A.9-12**.

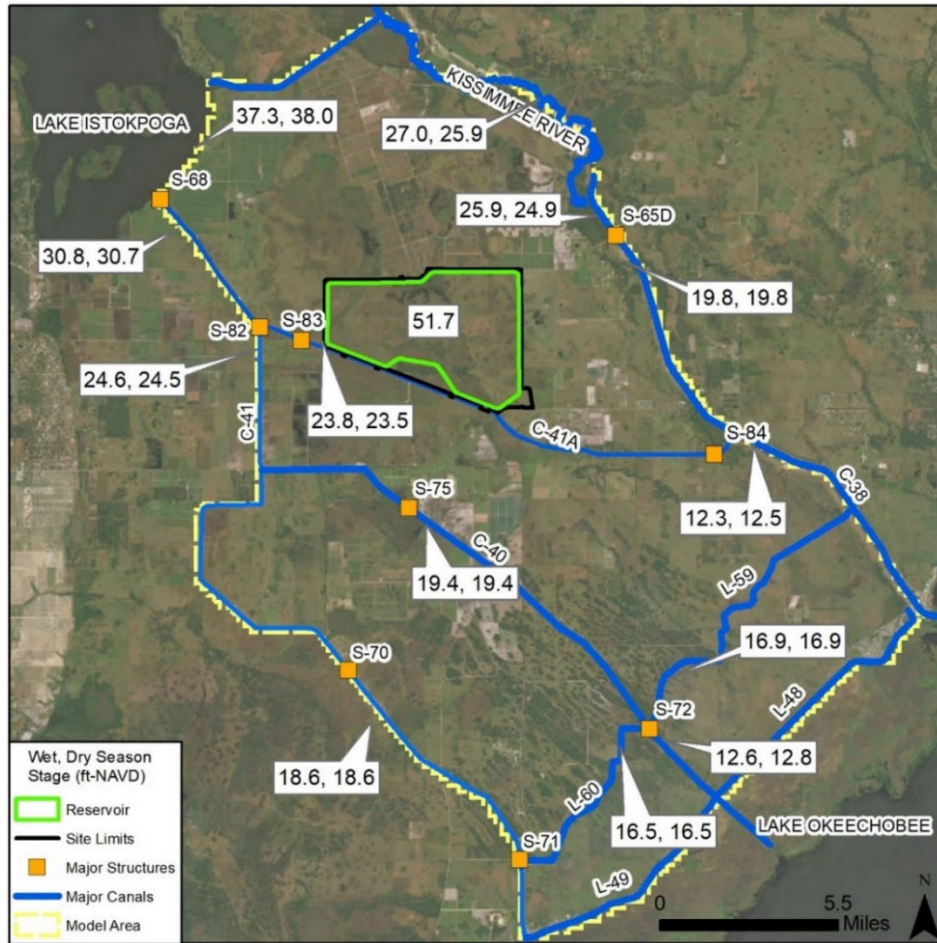

Figure A.9-12. Major canal and reservoir stage boundary conditions for the wet & dry seasons.

Control Elevations for Farm Canals and Other Properties

Data from various permits in the lands surrounding the reservoir was gathered to establish a range of control elevations for the drain boundaries. For the citrus and row crops farm fields, farm canals remove excess water above 3 feet below the ground. The canals in the Ru Mar property west of the reservoir and other pasture lands remove excess water above 2 feet below the ground surface. The control elevations in the without-project model for several ditches within the footprint of the future reservoir were set to be consistent with what is shown in the LiDAR. **Figure A.9-13** shows the drain boundaries and the farm canals. The farm canal layer was extracted from the SFWMD AHED database and modified to match the aerial imagery at various locations.

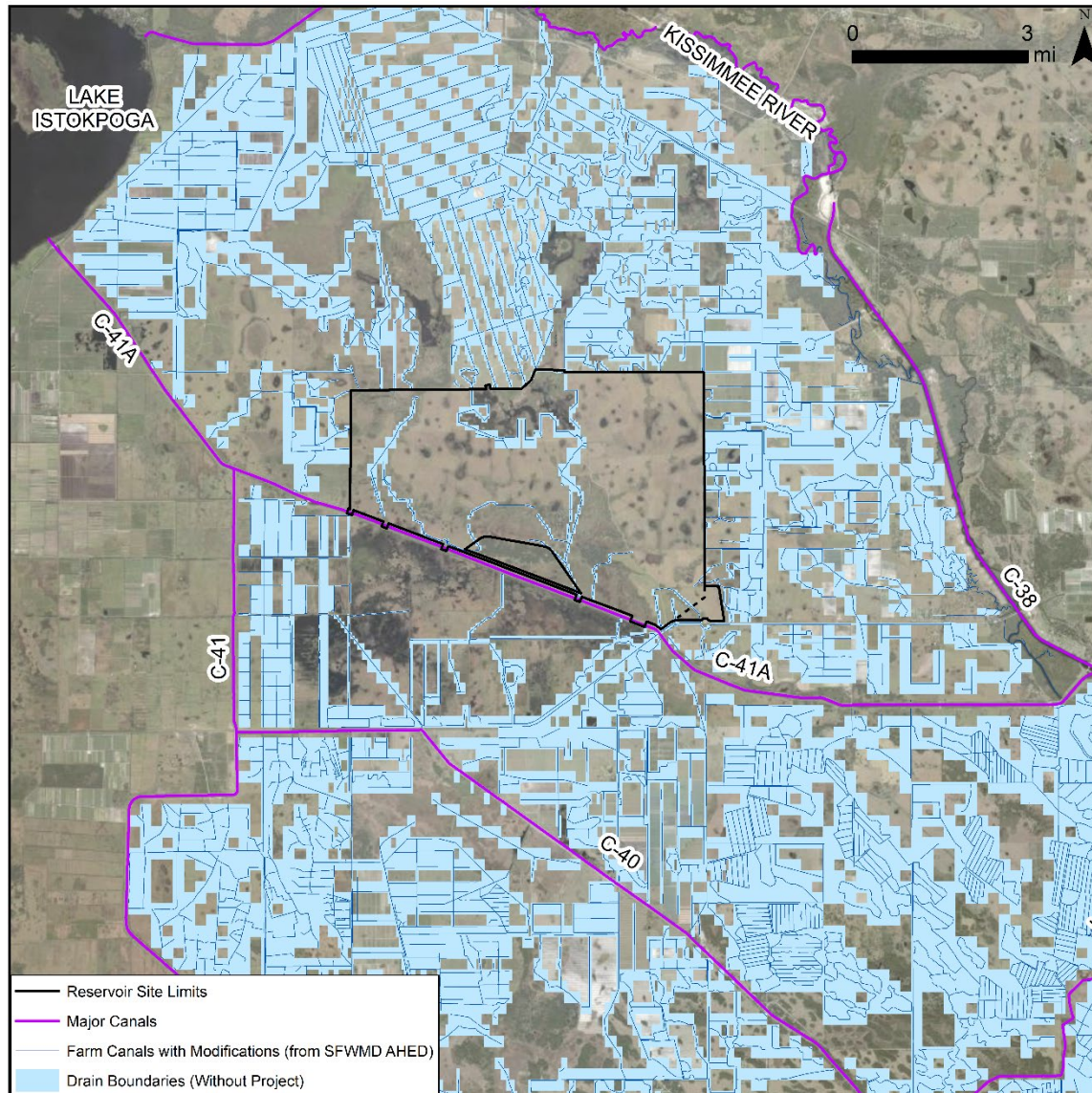

Figure A.9-13. Drain boundaries (model cells intersecting farm canals).

Conductance for Rivers and Drain Boundaries

In the groundwater flow equation, the conductance term combines the flow area that is perpendicular to the flow direction x conductivity / the length of flow normal to the flow direction. For most river and drain boundaries the conductance was calculated based on the MODFLOW conceptualization for the river boundary conductance (McDonald and Harbaugh, 1988):

$$C = \frac{K \times W \times L}{M}$$

Where, K = conductivity of the streambed material, W = width of the river, L = length of the reach, M = thickness of the streambed.

K was assumed to be the vertical conductivity of layer 1 (5.7 ft/d). W was estimated for the various types of canals based on the aerial image. For farm canals, the average width was assumed to be 25 feet. L was

calculated by intersecting the canal lines with the boundary cells and then calculating the length within each cell. M was assumed to be 1 foot, such that conductance is neither increased nor decreased by an unknown quantity. However, this value was then adjusted by a fraction based on the area of the cell relative to the area of the boundary in the cell, i.e., $M = 1 \text{ ft} \times [\text{Cell Area} / \text{Boundary Reach Area (WL)}]$. Thus, this conceptually accounts for longer travel distances to the boundary for relatively larger cells and thus, serves as a mechanism to reduce the influence of the boundary in large cells.

For the perimeter canal and the C-41A Canal a more detailed calculation of the conductance term was calculated based on a closer approximation of the true canal geometry and spatial intersection of the portion of the canal within each boundary cell vertically and horizontally. The following formulation was used similar to Hughes et al., 2012, which assumes that there is no additional vertical resistance at the bottom of the streambed and thus, the exchange is controlled by the aquifer conductivity.

$$C = \frac{Kh \times WP \times L_{reach}}{L_{node \text{ to } reach}}$$

where, C = conductance (ft²/d), Kh = aquifer horizontal hydraulic conductivity (ft/d), WP = wetted perimeter of the canal cross section in the cell (ft), L_{reach} = length of the river reach in the cell (ft), L_{node-to-reach} = distance between the center of the grid cell and the river reach (ft). For all drains and rivers, it was assumed that the exchange between the aquifer and canal is controlled by the aquifer hydraulic conductivity, i.e., there is no additional bed resistance due to accumulation of sediments in the channel. To calculate the wetted perimeter, length of the river and distance from the cell center to the river reach, a series of GIS processes are conducted where the segments of canal are intersected with each boundary cell to calculate the canal geometry of the intersected portions in each cell.

A.9.2.4.2 Summary of Project Features in the 3D Groundwater Model

The representation of the with-project model features is based on the latest design plans for the Recommended Plan reservoir. The project features are summarized in **Table A.9-6**.

Table A.9-6. Simulation of Project Features.

Project Feature	Boundary Depths/Elevations	Other Parameters
Reservoir Stage	CHB fixed at NFSL (51.7 ft NAVD88)	-
Cutoff wall	60 feet below ground, bottom elevation varies with topography	K = 1x10 ⁻⁶ cm/sec (0.003 ft/d) Width = 3 feet
Perimeter Canal	Drain boundaries that remove water above the control elevations in reaches	Bottom width = 16 feet; Side slopes = 3:1 (H:V) Bottom elevations = 21 ft below avg. ground elevation

Perimeter Canal Reaches

Due to the differing land elevation adjacent to the reservoir, the project design includes control weirs along the perimeter canals, which divide the canal into ten reaches with different control elevations, as shown in **Figure A.9-14**. The initial number of reaches and control elevations were determined by the project design engineers based on average variations in topography and other hydraulic considerations. The groundwater model was then used to adjust the target stages and number of reaches (i.e., control weirs) to minimize the simulated seepage impact. For each perimeter canal reach, **Table A.9-7** shows the length of the reach, the average ground elevation and the average bottom elevation based on an average

depth of 21 feet. The bottom width of the canal is 16 feet. The top width of the perimeter canal varies according to the ground elevations. Based on the average of the top and bottom elevations and channel slope, the top width is around 142 feet. The geometry of the perimeter canals is considered in the conductance term, as described above.

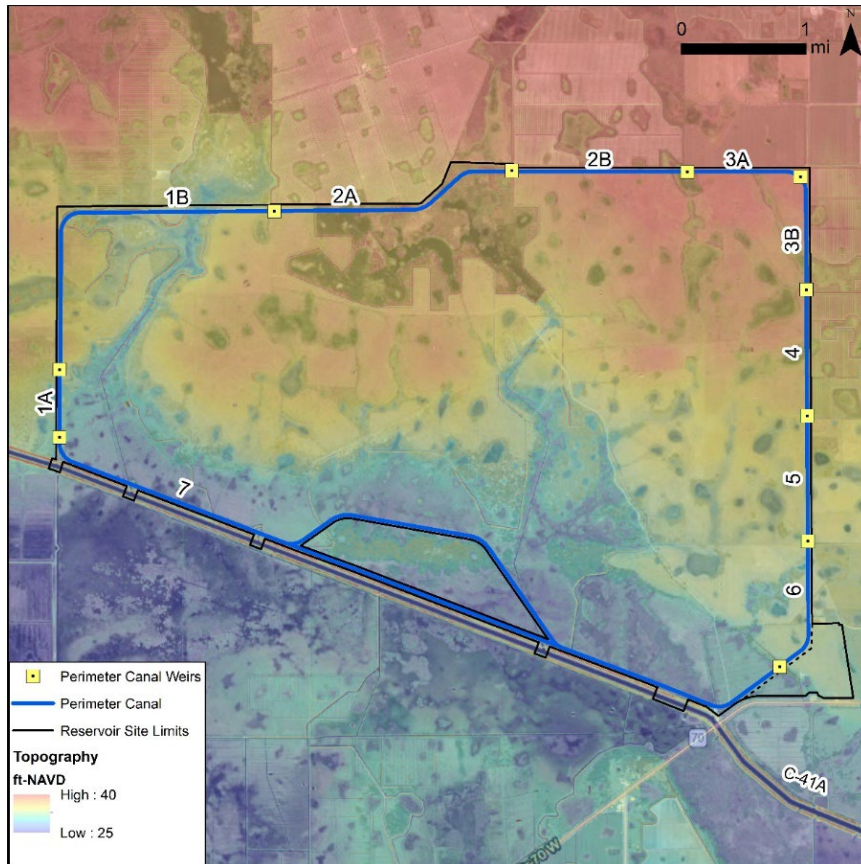

Figure A.9-14. Perimeter canal reaches and weir locations.

Table A.9-7. Perimeter Canal Reaches and Average Geometries.

Reach	Length (mi)	Average Ground Elevation (ft NAVD88)	Average Bottom Elevation (ft NAVD88)
1A	0.5	31.2	10.2
1B	3.0	35.2	14.2
2A	2.0	37.7	16.7
2B	1.4	39.3	18.3
3A	0.9	40.6	19.6
3B	0.9	39.7	18.7
4	1.0	36.8	15.8
5	1.0	34.2	13.2
6	1.1	32.0	11.0
7	6.8	28.0	7.0

¹Assuming an average depth of 21 feet below ground.

A.9.3 Simulated Seepage Impact

The simulated baseline (Without Project) groundwater elevations and depths in the areas in and around the reservoir site are shown in **Figure A.9-15** and **Figure A.9-16**, respectively, for wet and dry season conditions. The simulated baseline water table varies from around 47 to 13 feet NAVD88 in the model area and from around 42 to 23 feet NAVD88 near the project site. The simulated water table depths are around 1 to 3 feet below ground in the agricultural fields. Some ponding is simulated in wetland areas with low drainage, where depths are at or above ground. On average the simulated water table is 1.3 feet higher in the wet season than in the dry season.

The results of the model simulations for the Future With Project and Future Without Project models are described below in terms of head differences and seepage flows along each reach of the perimeter canal.

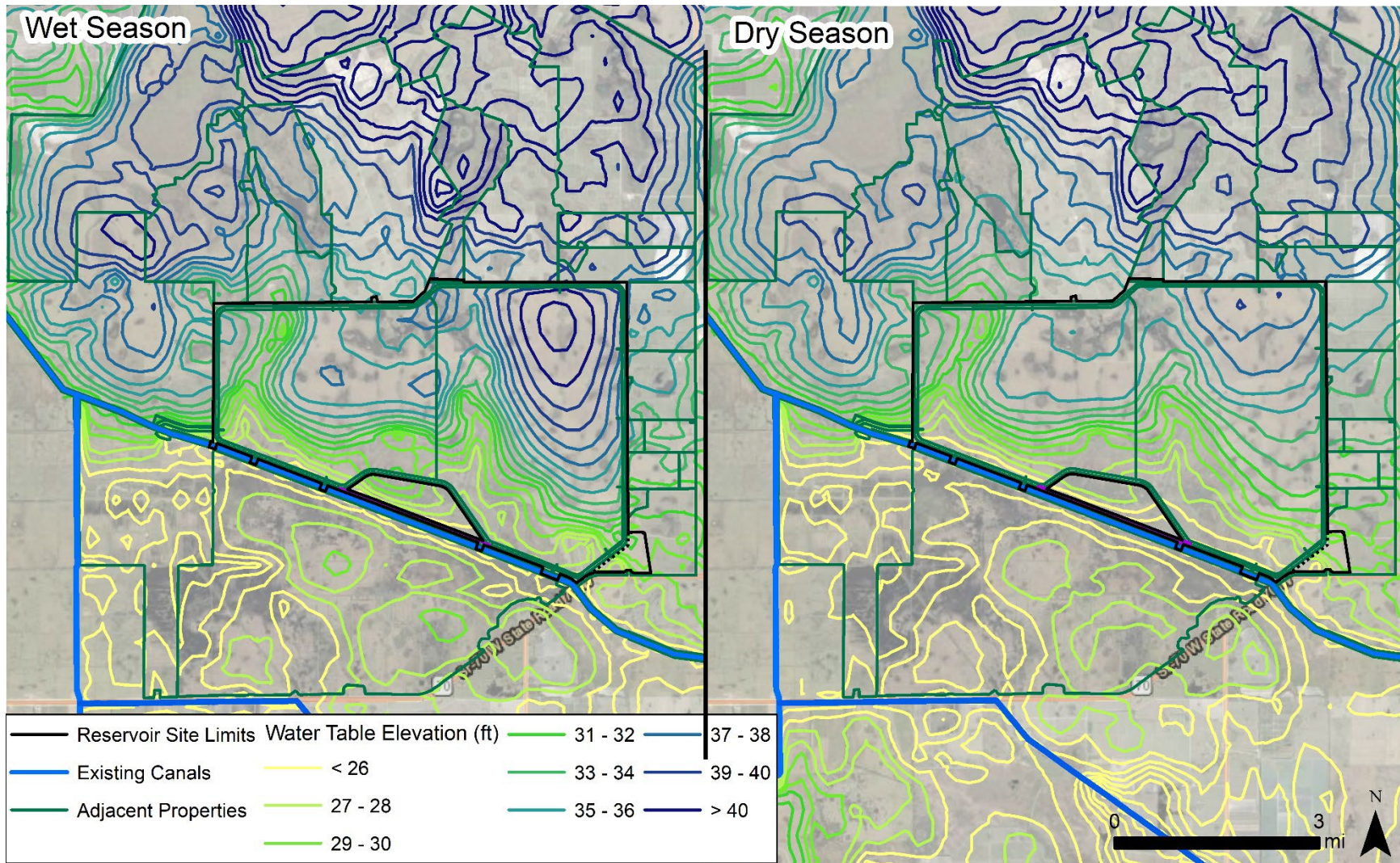

Figure A.9-15. Future Without Project Simulated Groundwater Levels in wet and dry season conditions.

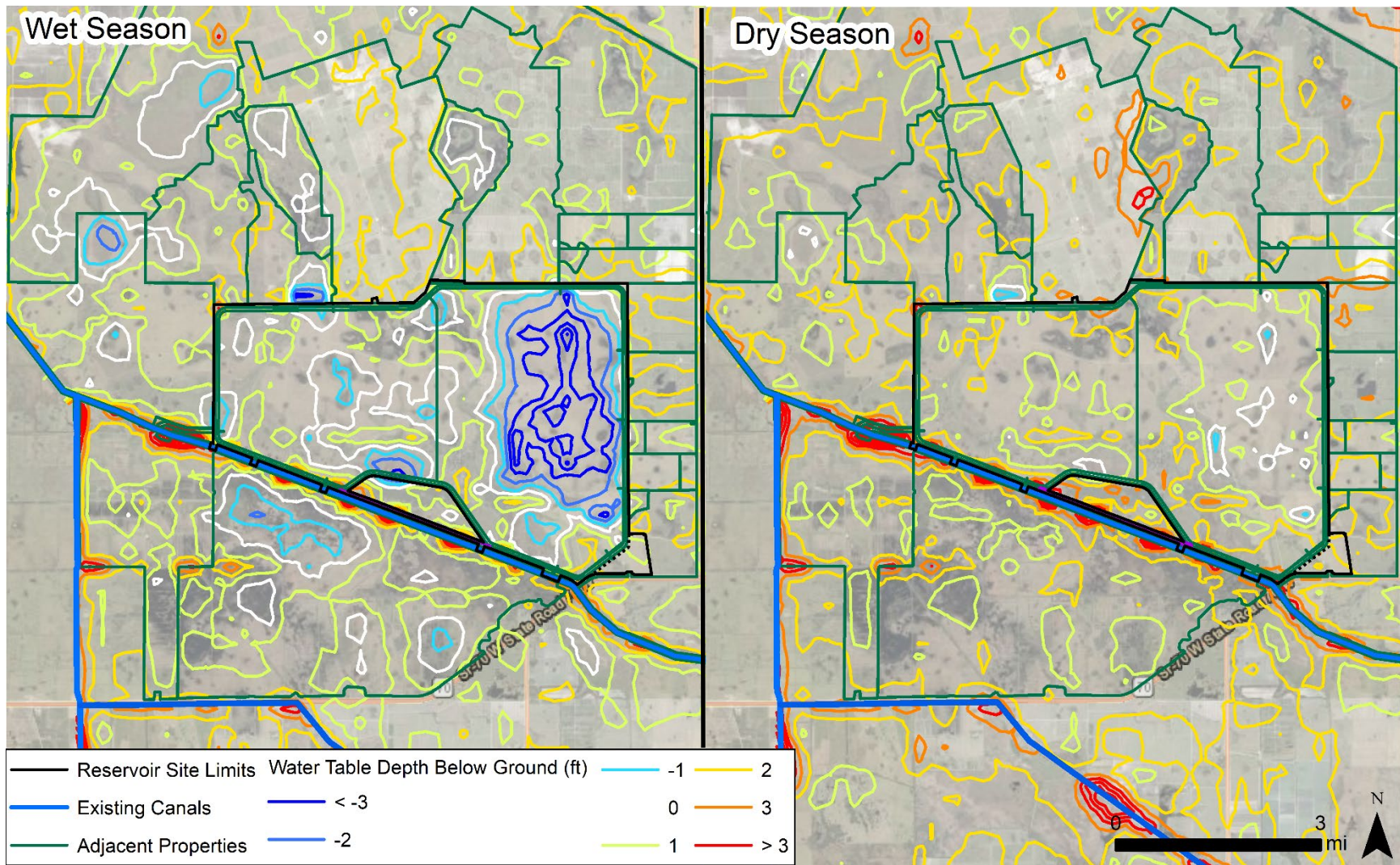

Figure A.9-16. Future Without Project Simulated Depth Below Ground (positive below ground, negative above ground) in wet and dry season conditions.

A.9.3.1 Perimeter Canal Control Elevation Optimization

The initial control elevations estimated in the preliminary cross-section drawings were optimized using the 3D groundwater model to minimize seepage impact to adjacent land for the wet and dry season conditions. Several iterations were conducted with both the wet season and dry season models to find the optimal control elevations that minimize seepage impact. In most sides of the reservoir, when using the initial control elevations the project impact in the adjacent water table is a net drawdown rather than a seepage outflow. This is because the initial control elevations were lower than the assumed control elevation in the adjacent farm fields. To optimize the stages, the average simulated water table for baseline conditions along each reach was calculated as a starting estimate of the optimal stage in the reach and then iteratively adjusted to minimize the simulated impact. In reaches where due to variations in topography and land use, a given stage may produce both seepage and drawdown within the reach, the control elevation was set to balance the net impact. As previously mentioned, the number of weirs was adjusted during this exercise in coordination with the project design engineers. In some locations the weir locations were placed to coincide with the adjacent property/farm boundaries.

Table A.9-8 shows the optimized stages for Reaches 1 to 6 for the wet season and dry season models. The Reach 7 control elevation was not optimized because it is within the normal operating range of the adjacent C-41A canal reach between S-83/S-83X and S-84/S-84X, where the stage is normally controlled between 23.1 and 24.0 ft NAVD88.

Table A.9-8. Perimeter Canal Reaches 1 through 7 Control Elevations for the Wet & Dry Season.

Reach	Control Elevation (ft NAVD88)		
	Initial	Dry Season Optimized	Wet Season Optimized
1A	27	30.2	31.0
1B	27	33.3	34
2A	29	35.2	35.5
2B	29	37.8	38.5
3A	31	38.3	39.1
3B	31	36.3	37.1
4	29	33.7	34.9
5	27	32.6	33.8
6	25.5	30.8	31.4
7*	24	N/A	N/A

*The Reach 7 control elevation was not optimized because it is within the normal operating range of the adjacent C-41A canal reach between S-83/S-83X and S-84/S-84X, where the stage is normally controlled between 23.1 and 24.0 ft NAVD88.

Figure A.9-17 show the head difference contour maps (with project minus without project) for the optimized control elevations in wet and dry season conditions. The maps show that on most sides of the reservoir, drawdown was effectively reduced with the higher control elevations (optimized control elevations). However, in a few reaches the results show a small impact that is difficult to eliminate with a single stage. It should be noted that in some cases the seepage impact may be beneficial, for example, in wetland areas that can be experiencing water table drawdown from the existing canals. A description of these areas, including the current land use classification (per the SFWMD 2017-2019 dataset), future land use projection and estimated distance of the impact, i.e., the distance between the boundary of the project site boundary and the +0.5 (seepage) or -0.5-foot (drawdown) contours, follows below.

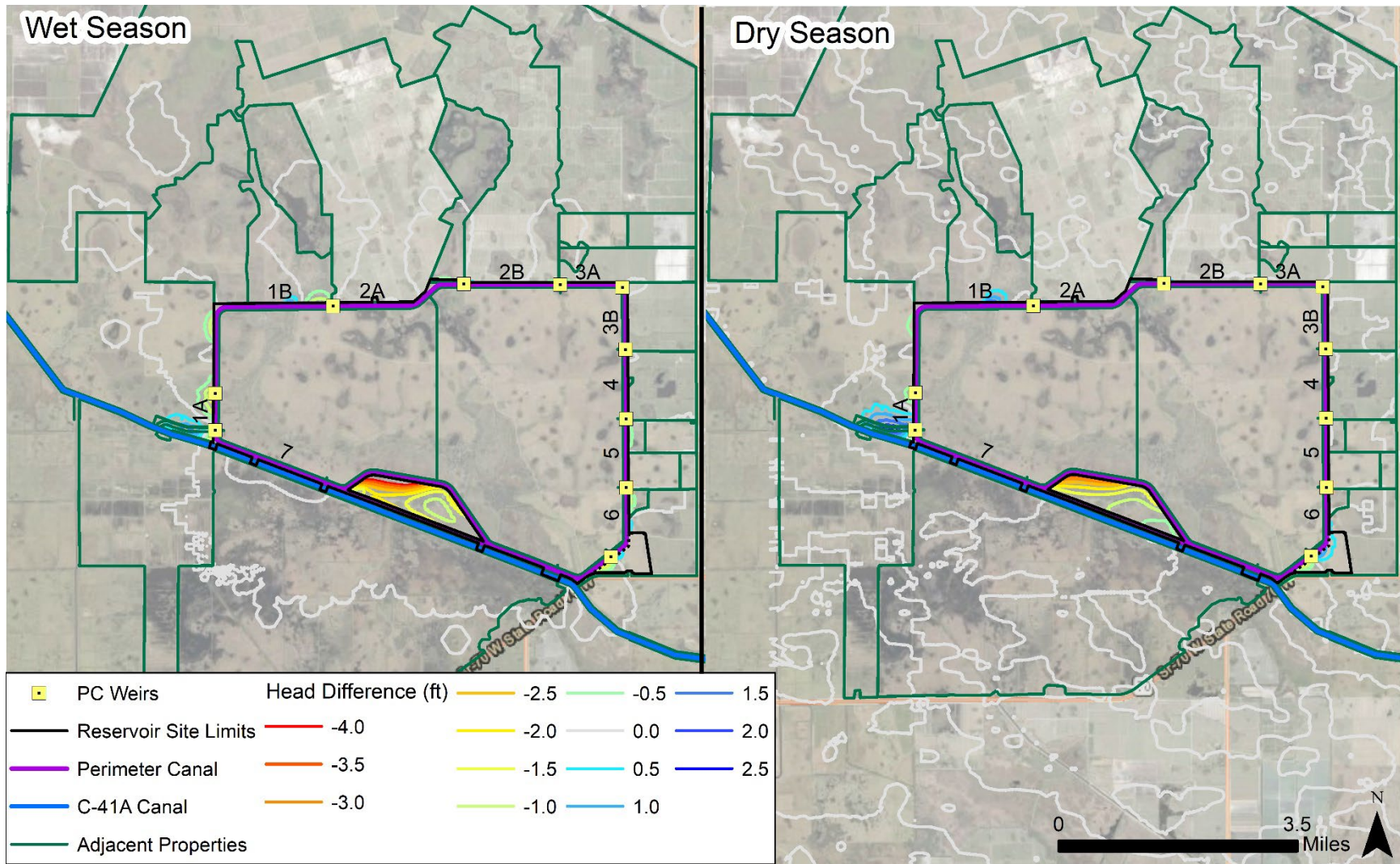

Figure A.9-17. Head difference (Future With Project minus Future Without Project) in wet and dry season conditions for the optimized perimeter canal control elevations.

1. Reach 1A – On the southwest side of the reservoir, seepage is simulated between the connection of the perimeter canal to the reservoir outflow canal that discharges to the C-41A, upstream of S-83. This area, part of the RuMar property, is classified as unimproved pastures with imbedded mixed wetland areas. The simulated baseline (Without Project) water depths at the location showing seepage impact are relatively high (3 to 6 feet below ground) due to the influence of the low stages in the C-41A canal downstream of the S-83 structure. Thus, the reservoir outflow connection may serve to counterbalance the low water table in this area. The distance from the project site to the 0.5-foot contour is approximately 200 feet and 900 feet in the wet season and dry season, respectively. Further north in reach 1A, near the connection with reach 1B, drawdown is simulated. The distance from the project site to the -0.5-foot contour is approximately 1,200 feet and 640 feet in the wet season and dry season, respectively. To prevent this drawdown the control elevation in reach 1A would have to be increased by 1 to 3 feet, which would increase the seepage caused in the southern connection. Thus, the operation of the reach needs to be coordinated with the management target of the property.
2. Reach 1B – On the northwest of the side of the reservoir, a combination of drawdown and seepage is simulated. Drawdown is simulated on the west side of the reservoir south of the canal bend, which is part of the RuMar property and is classified as improved pastures. Seepage and drawdown are simulated on the north side of the reach, east of the canal bend and east of the Lykes property citrus farm area located on the northwest corner of the reservoir. This area is currently classified as a mixture of unimproved pastures and wetland areas, and it is projected that it may be a site for an AGI that can control runoff from the adjacent farm area. An additional weir was tested that splits this reach in the middle of the canal bend but the optimal control elevations in the two reaches ended up being the same because the baseline water table in the Lykes citrus farm area is lower than the RuMar property impact area due to both topography and the drainage management assumptions. Thus, the additional weir was eliminated for hydraulic efficiency purposes. The distance from the project site to the -0.5-foot contour in the west side is approximately 740 feet and 500 feet in the wet season and dry season, respectively. The distance from the project site to the 0.5-foot contour in the north side is approximately 160 feet and 410 feet in the wet season and dry season, respectively and to the -0.5-foot contour in the same area is approximately 865 feet and 0 feet in the wet season and dry season, respectively.
3. Reach 6 – On the southeast side of the reservoir, a combination of drawdown in the north portion and seepage in the south portion is simulated. This area is owned by the Lykes Bros, Inc. and is mostly classified as improved pastures with some wetland areas and it includes a portion of the LOCAR project temporary construction office and staging area that will be returned to Lykes after construction. The topography along Reach 6 varies from just above 33 feet NAVD88 in the north to just below 30 feet NAVD88 in the south and the baseline water table varies from north to south following the topographic gradient, with depths ranging from 1 to 2 feet below ground. However, the simulated impact may be beneficial when considering when it occurs. For example, the simulated drawdown impact on the north is higher in the wet season than in the dry season and the simulated seepage in the south is higher in the dry season than in the wet season. The distance to the -0.5-foot contour in the north side is approximately 500 feet and 0 feet in the wet season and dry season, respectively and distance to the 0.5-foot contour in the south side is approximately 105 feet and 280 feet in the wet season and dry season, respectively. Thus, the

optimal management of the seepage canal will depend on the season that the target water management of the area.

4. Reach 7 – The plots indicate head differences up to 3.5 feet within Offsite Drainage Area (ODA) No. 7A (as labeled on the Overall Site Plan for Recommended Plan included in **Annex C-1**). During the PED phase modification of the perimeter canal control elevation adjacent to ODA No. 7A may be necessary. This could be accomplished with additional control weirs along this segment of the perimeter canal or other methods.

A.9.3.2 Simulated Flows along Perimeter Canal Reaches

Seepage flows along the lengths of each perimeter canal reach for the optimized control elevations are shown in **Table A.9-9** and **Table A.9-10** for the wet and dry season, respectively. The tables show the seepage out of the reservoir constant head boundary (i.e., across the cutoff wall) and the excess flow extracted by the perimeter canal river boundary cells for each reach, and the difference between the two flows. If the difference is negative, (i.e., the reservoir outflow is less than the flow extracted by perimeter canal), then net drawdown is occurring along the reach from adjacent lands. If the difference is positive, (i.e., reservoir outflow is greater than the flow extracted by perimeter canal), then either seepage is occurring along the reach or a portion of the reservoir outflow along the reach moves to adjacent reaches with lower stages. To estimate the magnitude of the seepage impact on the farm fields, the difference in flow extracted from the farm canals (drain boundaries) with and without project were calculated (**Table A.9-11** and **Table A.9-12**).

Table A.9-9. Wet Season Simulated Outflow from Reservoir and from Perimeter Canal.

Reach	Length (mi)	Stage (ft-NAVD88)	Outflow from Reservoir (cfs)	Flow Extracted by Perimeter Canal (cfs)	Flow Difference (cfs)
1A	0.5	31.0	0.3	0.4	-0.1
1B	2.9	34.0	1.6	1.1	0.5
2A	2.0	35.5	1.2	0.9	0.2
2B	1.4	38.5	0.6	0.2	0.3
3A	0.9	39.1	0.4	0.1	0.3
3B	0.9	37.1	0.6	0.4	0.2
4	1.0	34.9	1.0	0.7	0.3
5	1.0	33.8	0.8	0.5	0.3
6	1.1	31.4	0.3	0.0	0.4
7	6.8	24.0	6.9	10.3	-3.4
Total	18.7	51.7 ¹	13.7	14.7	-0.9

¹ Reservoir stage

Table A.9-10. Dry Season Simulated Outflow from Reservoir and from Perimeter Canal.

Reach	Length (mi)	Stage (ft-NAVD88)	Outflow from Reservoir (cfs)	Flow Extracted by Perimeter Canal (cfs)	Flow Difference (cfs)
1A	0.5	31.0	0.3	0.4	-0.1
1B	1.3	34.0	1.7	1.1	0.6
2A	1.7	35.5	1.2	0.7	0.5
2B	2.0	38.5	0.6	0.3	0.3

Reach	Length (mi)	Stage (ft-NAVD88)	Outflow from Reservoir (cfs)	Flow Extracted by Perimeter Canal (cfs)	Flow Difference (cfs)
3A	1.4	39.1	0.4	0.2	0.2
3B	0.9	37.1	0.6	0.5	0.1
4	0.9	34.9	1.1	0.9	0.2
5	1.0	33.8	0.9	0.7	0.2
6	1.0	31.4	0.4	0.0	0.4
7	6.8	24.0	6.9	7.9	-1.0
Total	18.7	51.7 ¹	14.1	12.8	1.3

¹ Reservoir stage

The total flow out of the reservoir is much lower than values reported for other studies of SFWMD reservoirs and impoundments (MHW, 1999; Abteu and Piccone, 2018; SFWMD, 2019), which indicates the effectiveness of the cutoff wall and the relatively low hydraulic conductivities of the aquifer materials in comparison to the other studies. The studies cited are in the EAA where limestone layers have much larger transmissivities. Moreover, some of the impoundments in these studies do not have a cutoff wall. The analysis conducted by the project geotechnical engineers of the soils profiles in the borings collected around the perimeter of the reservoir indicates the large presence of clay materials with low permeabilities. In Corps (2017), the middle and deeper layers were interpreted with much larger permeabilities, which resulted in much higher outflows from the reservoir. Thus, an accurate assessment of the distribution and permeability of materials is critical in determining the seepage impact from the reservoir. To illustrate the impact of the material permeability in the reservoir outflow, a sensitivity analysis was conducted and is described in **Section A.9.3.4**.

The excess flow extracted from the adjacent farm fields drain boundaries (with model reach IDs as shown in **Figure A.9-18**) is shown in **Table A.9-11** and **Table A.9-12**. This excess flow represents an estimate of the volume of runoff that may need to be pumped out of the farm fields in order to maintain the target control elevations.

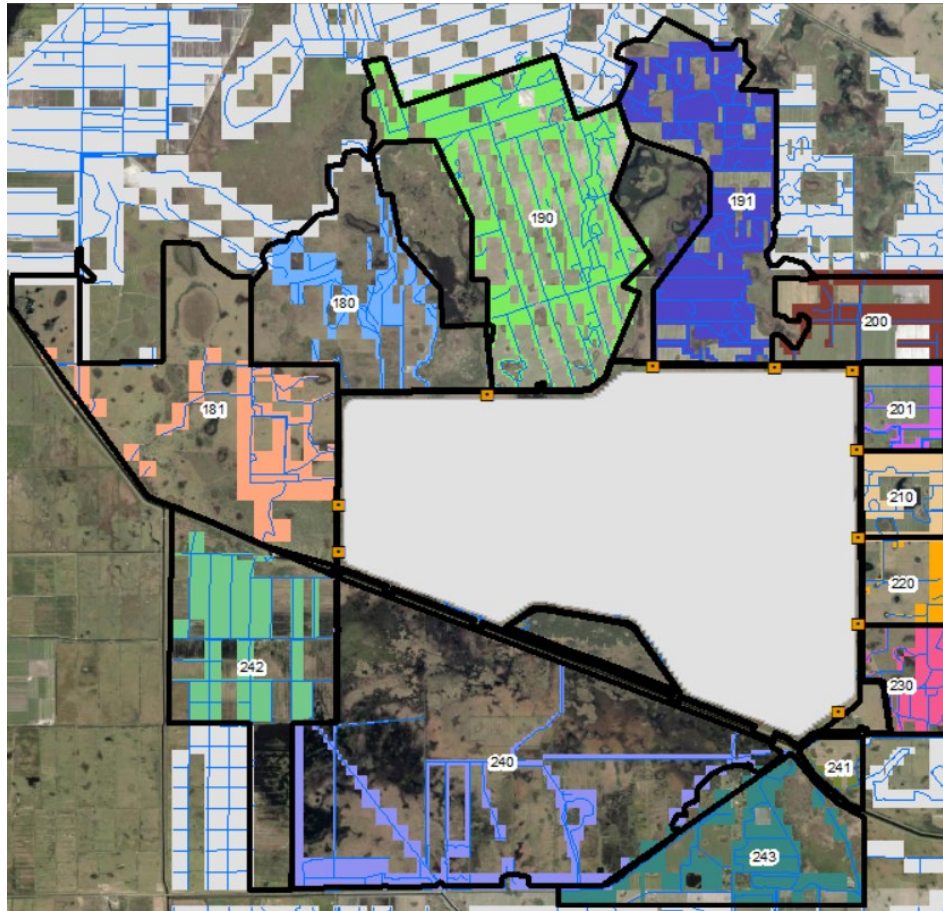

Figure A.9-18. Model identifiers for the drain reaches corresponding to adjacent farm canals in Table A.9-11 and Table A.9-12.

The tables show that the total difference in the flow extracted in the areas shown above between With and Without Project conditions is 1.0 and 1.3 cfs in the wet season and dry season, respectively. For an area with an acreage of 32,958-acres this is a very small amount of flow. The largest contribution to this difference in flow occurs in the northwest property, Lykes Bros, Inc. Basinger Tract Basin 4 (model reach 180). As previously stated, this area is undergoing plans to modify the drainage management system by adding AGIs that will serve to manage the farm runoff and this system will be connected to the perimeter canal via their outflow structures.

Table A.9-11. Wet Season Excess Flow Extracted by the Farm Canals (Drain Boundaries).

Model Reach (indicated on Figure A.9-18)	With Project Flow (cfs)	Without Project Flow (cfs)	Difference (cfs)	Total Area (acres)
180	5.5	5.0	0.5	2,883
181	3.7	3.7	0.0	4,553
190	17.1	17.0	0.1	4,476
191	8.2	8.0	0.2	3,178
200	3.0	2.9	0.1	1,202
201	2.8	2.7	0.1	664
210	3.3	3.3	0.1	640

Model Reach (indicated on Figure A.9-18)	With Project Flow (cfs)	Without Project Flow (cfs)	Difference (cfs)	Total Area (acres)
220	1.4	1.3	0.1	655
230	2.5	2.5	0.0	881
240	8.3	8.3	0.0	8,095
241	0.7	0.8	-0.1	264
242	3.2	3.2	0.0	3,251
243	5.1	5.1	0.0	2,214
Total	64.7	63.7	1.0	32,958

Table A.9-12. Dry Season Excess Flow Extracted by the Farm Canals (Drain Boundaries).

Reach (indicated on Figure A.9-18)	With Project Flow (cfs)	Without Project Flow (cfs)	Difference (cfs)	Total Area (acres)
180	2.8	2.3	0.5	2,883
181	1.7	1.6	0.0	4,553
190	8.4	8.1	0.3	4,476
191	3.9	3.8	0.2	3,178
200	2.0	1.9	0.1	1,202
201	1.3	1.3	0.0	664
210	1.7	1.6	0.1	640
220	0.8	0.7	0.1	655
230	1.4	1.4	0.1	881
240	3.6	3.6	0.0	8,095
241	0.4	0.4	0.0	264
242	1.4	1.4	0.0	3,251
243	2.9	2.9	0.0	2,214
Total	32.3	31.0	1.3	32,958

A.9.3.3 Sensitivity of the Reservoir Seepage Outflow with Varying Conductivities

Seven sensitivity analysis runs were conducted to estimate the uncertainty of the predictions above due to assumed permeability of materials using the wet season model with the optimized perimeter canal elevations. In particular, the relatively low conductivities in units B, C, and D lead to a relatively low outflow from the reservoir and a low seepage coefficient. Since this has important implications for the need and design of a cutoff wall, the sensitivity runs focused on increasing the permeabilities of all units by one order of magnitude in various combinations as shown in **Table A.9-13**.

Table A.9-13 shows the simulated seepage outflow from the reservoir for wet season conditions and the seven additional sensitivity analysis simulations with the same conditions but with the changes in conductivities described above. Note that this sensitivity analysis was conducted prior to the final optimization of the perimeter canal and thus, the baseline run shows a higher value than **Table A.9-9** because it used lower stages than the final optimized stages.

Table A.9-13. Wet Season Simulated Seepage Outflow from the Reservoir and Removed by Perimeter Canal with Varying Aquifer Conductivities.

Simulation	Unit(s) where Conductivity was Changed by Increasing Kh & Kv by Factor of 10	Outflow from Reservoir (cfs)	Removed by Perimeter Canal (cfs)	Net Drawdown (-) or Seepage (+) (cfs)
Baseline K	None	14.9	-23.2	-8.3
KSA_UA	A	16.3	-32.8	-16.6
KSA_UB	B	34.4	-43.5	-9.1
KSA_UC	C	31.8	-36.4	-4.5
KSA_UD	D	39.8	-40.8	-1.0
KSA_UBC	B & C	68.9	-74.7	-5.8
KSA_UBCD	B, C & D	105.2	-103.8	1.4
KSA_UABCD	A, B, C & D	136.5	-144.9	-8.4

The results show a large sensitivity of the seepage outflow from the reservoir to the changes in conductivities. The increased flow also changes the seepage impact from net drawdown to net seepage. Note that only total flow is shown and not the localized impacts in the various reaches. Thus, the control elevations would have to be lowered, as instead of raised in some cases, to minimize impact of the project. It should be noted that the conductivities tested for Unit A are in the higher range or substantially higher than conductivities reported for the surficial aquifer in other studies of the area (Sepúlveda et al., 2012; Butler et al., 2014). Thus, runs KSA_UA and KSA_UABCD are likely too conservative. A more thorough assessment of the permeability of materials is highly recommended during the PED phase to estimate seepage impact with a higher degree of certainty.

A.9.3.4 Sensitivity of the Farm Canal Parameters and Boundary Type

Farm canals are coarsely represented in the model due to the limited knowledge of the canals and the canal management at this phase of the project. To assess the magnitude of the error in the model predictions due to the uncertainty of the farm canal data, a sensitivity analysis was conducted that tested various parameters and the type of boundary (river versus drain) used to represent the canals. The parameters varied included the canal width and the bed resistance used in the conductance calculation, and the control elevations (as depths relative to ground elevation). The canal widths varied from 5 to 55 feet, with a baseline value of 25 feet. The canal – aquifer resistance (i.e., the conductivity of the streambed materials) varied from 1 to 30 feet/day, with a baseline value of 28.5 feet/day. The control depths varied from 5 to 0 feet below ground, with a baseline value of 3 feet. The model output measured for sensitivity was the flow extracted by the farm canals in the adjacent properties. The measure of sensitivity is based on the Composite Scaled Sensitivity (CSS) formulation (Hill and Tiedeman, 2007), which normalizes the change in the output over the change in the parameter by the magnitude of the baseline parameter. The wet season with project model was used for this analysis. For the PED phase, it is recommended that this type of sensitivity analysis is extended to dry season conditions as well. **Figure A.9-19** shows the relative CSS of the parameters. For this calculation, the river boundary control elevation changes were compared to the baseline control elevation in the river boundary simulation. The figure illustrates the higher sensitivity of the control elevations to the canal properties that influence the conductance calculation. This illustrates the importance of better understanding the management targets in order to assess the magnitude of the seepage impact.

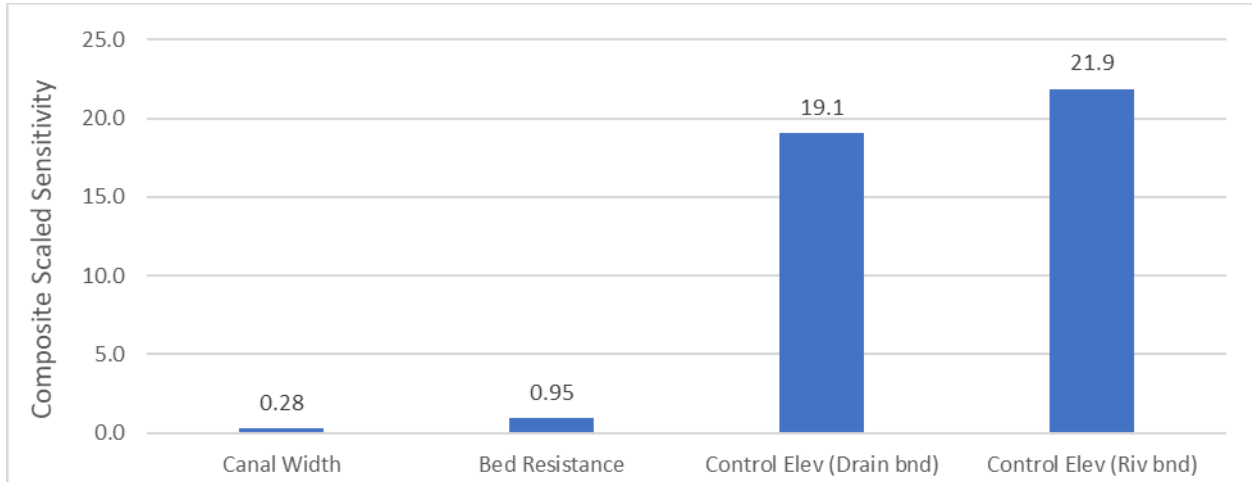

Figure A.9-19. Sensitivity of Farm Field Canal Flow to Farm Canal Properties

Figure A.9-20 shows the difference in flow extracted by the farm canals when using drain versus river boundaries to represent the farm canals. Note that flow extracted by the boundary is reported as negative (outflow). For this calculation, the extracted flow signs were flipped (i.e., if sink converted to + and source to -). The total flow extract for all the adjacent farm fields was added. In all cases, the drain boundary leads to a larger flow extraction than the river boundary because the drain boundaries are never a source of flow. The higher the control elevations (lower depths) the higher the differences in the flow extracted because as the elevation of the river boundary increases relative to other water budget processes it is more likely to become a source rather than a sink. These results illustrate that the drain boundary is more conservative in representing the seepage impact to the farm fields.

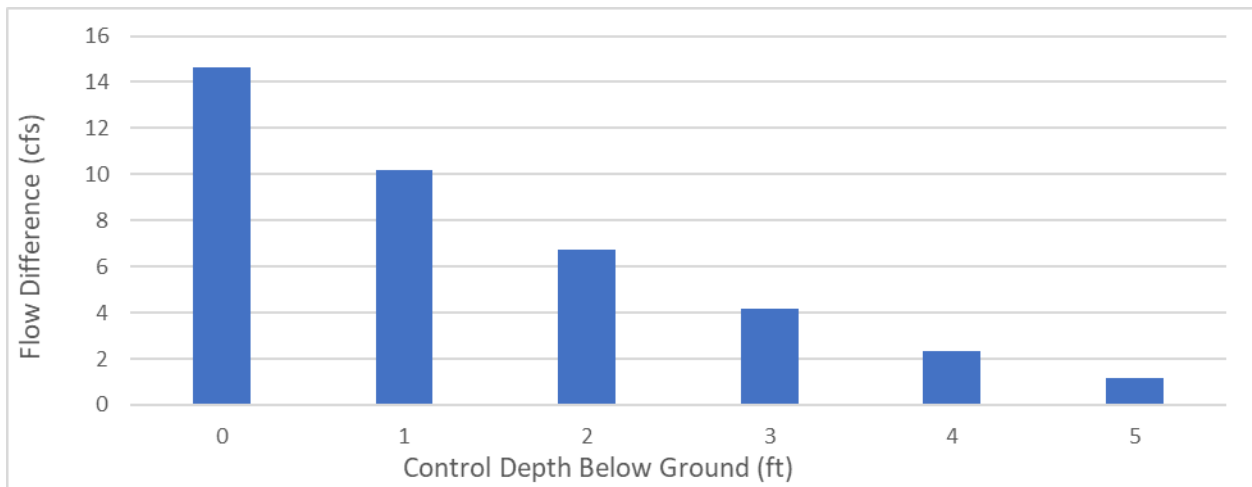

Figure A.9-20. Difference in Flow Extracted by Farm Canal Boundary (Drain minus River)

A.9.3.5 Sensitivity of the Perimeter Canal Conductance

The baseline conductance of the perimeter canal, as described in **Section A.9.2.4.1** assumes that the resistance to flow between the aquifer and the canal is controlled by the hydraulic conductivity of the aquifer. Since the perimeter canal only crosses layer 1, the baseline hydraulic conductivity in the

conductance equation is 28.3 feet/day. Two simulations were conducted reducing the conductance of the perimeter canal by one and two orders of magnitude to represent the potential increase in flow resistance with fine sediment accumulation. Thus, the conductivity of the added sediment layer in the first and second simulation is 2.8 and 0.28 feet/day, respectively. **Table A.9-14** shows the effect on the seepage flow from the reservoir and the flow extracted by the perimeter canal with a reduction in conductance compared to the baseline conductance. Reducing the conductance by one order of magnitude had a small effect on the reservoir and perimeter canal flow, lowering the reservoir seepage outflow by 0.1 cfs, the perimeter canal removal by 0.2 cfs, and net drawdown by 0.1 cfs. Reducing the conductance by two orders of magnitude had the effect of lowering the seepage outflow by 0.6 cfs (4%), the flow extracted by the perimeter canal by 2.3 cfs (16%) and changing the net project impact from net drawdown to net seepage. The implication of these results is relevant for the maintenance and operations of the perimeter canal. With potential sedimentation, additional pumping may have to be conducted to drawdown the stages in the canal further than the optimal stages without sedimentation to counter act the effect of the reduced conductance.

Table A.9-14. Wet Season Simulated Seepage Outflow from the Reservoir and Removed by the Perimeter Canal with Varying Perimeter Canal Conductance.

Simulation	Outflow from Reservoir (cfs)	Removed by Perimeter Canal (cfs)	Net Drawdown (-) or Seepage (+) (cfs)
Baseline Conductance	13.67	14.64	-0.97
Conductance x 0.1	13.57	14.40	-0.87
Conductance x 0.01	13.09	12.30	0.79

A.9.4 Model Limitations and Recommendations

The 3D groundwater models developed for this project feasibility phase are steady-state models with simple water budget assumptions. The 3D groundwater models were not calibrated due to schedule and data constraints. The following recommendations are proposed for the PED phase for improvements to the 3D groundwater model and seepage impact analysis.

1. Expansion of the boring data locations. The spatial location of the logs should be well distributed around the perimeter of the reservoir, as well as at radial distances away from the reservoir, in the zones of potential impact in the adjacent lands. Furthermore, the depths of the boring logs should extend a distance further than the proposed depth of the cutoff wall to capture the permeability of the materials where the deep seepage from the reservoir occurs.
2. A hydrogeologic data analysis of the boring materials and permeabilities from a regional perspective in the context of the hydrostratigraphy layer units is recommended to construct an appropriate 3D groundwater conceptual model. In other words, site specific information that is collected for the geotechnical analysis should be extended and expanded upon when developing the hydrogeological model in order to make well informed assumptions in the development of the layer surfaces that take into account the regional hydrogeology.
3. Addition of the groundwater monitoring wells at various locations near the project site and installation of automatic measuring devices to obtain high frequency groundwater level data that can be used for long-term model calibration. This process should start as soon as possible to be

able to collect sufficient data before and during the design phase. Ideally, at least a full year or longer of continuous data should be available for calibration.

4. Development of a time varying, integrated surface water and groundwater model that includes complex hydrologic/hydraulic dynamics (runoff, unsaturated zone processes, water management exchanges, and channel hydraulics) be developed and calibrated over long-term conditions. This model would include a refined and calibrated 3D groundwater model.
5. The calibration process should also include thorough sensitivity and predictive uncertainty analyses of hydrologic parameters that impact the water table predictions, hydraulic conductivities, and aquifer-canal conductances.
6. Recharge and boundary conditions extracted from the integrated surface water and groundwater model can then be used to better define two or more steady-state conditions to input into a refined 3D groundwater model to evaluate seepage impacts. This model will have the same groundwater model as the integrated model but with a higher resolution grid that can represent the project seepage control features in greater detail.
7. The groundwater model resolution and type of numerical grid should be further refined and verified. Verification with 2D cross section models using similar layering is recommended to ensure that flow errors across the project features are not introduced due to the numerical horizontal and vertical grid resolution.
8. During the PED phase, a frost protection, groundwater well pumping scenario should be simulated using the updated/improved LOCAR 3D seepage model to be prepared during the PED phase; to determine the drawdown effect that these well pumps would have on the water table around the reservoir, during frost protection pumping that would likely happen during the dry season. The well pumps to be input into the 3D seepage model for this simulation would include, but not necessarily be limited to the permitted water supply wells around the LOCAR site, shown on **Figure E-11** in **Appendix E**. For each well pump input into the 3D seepage model, a determination should be made on its pumping capacity and its water supply source, which would include either the surficial, intermediate or Floridan aquifer. The results from this 3D simulation would then be used during the PED phase, to run 2D seepage/slope stability simulations for this frost protection pumping scenario.
9. During the PED phase, Scenarios 1 and 2 of the PMF as defined in DCM-2 (see **Section A.5.3.1** and **Annex A-2.1** for additional information about these scenarios) should be simulated using the updated/ improved LOCAR 3D seepage model to be prepared during the PED phase; to determine the contribution that seepage outflow from the reservoir would make to lowering the MWSL simulated in PMF Scenarios 1 and 2. If DCM-2, Design Case 1 governs the freeboard requirement for the reservoir perimeter dam, then the results from these two PMF seepage simulations could be considered in determining the required freeboard for the perimeter dam. **Appendix A, Section A.9.4** has been updated to include the recommendation that this PMF seepage scenario be simulated using the updated/improved LOCAR 3D seepage model during the PED phase.
10. Although the cutoff wall depth was assumed at 60 feet for this phase, further optimization of the cutoff wall depth should be performed during the PED phase as additional more detailed

geotechnical investigations come available. The optimization of the cutoff wall should be incorporated into the 3D groundwater model at that time.

A.9.5 References

- Abteu W. and Piccone, T., 2018. A-1 Flow Equalization Basin Seepage Study. SFWMD Technical Publication WR-2018-002. Revised August 16, 2018.
- Butler, D., Bandara, U., Smith, K., Sweazy, C. and Rani, R., 2014. Lower Kissimmee Basin Groundwater Model Update Summary Report. South Florida Water Management District Resource Evaluation Section Water Supply Bureau Water Resources Division. August 2014.
- Corps (U.S. Army Corps of Engineers), 2017. Technical Memorandum: Preliminary summary of soils and shallow subsurface geological characteristics on the footprints of the proposed K-42 and K-05 reservoir sites, Highlands and Glades Counties, Florida, for the Lake Okeechobee Watershed Restoration Project. October 10, 2017.
- Food and Agriculture Organization, 1998. Crop Evapotranspiration – Guidelines for Computing Crop Water Requirements – FAO Irrigation and Drainage Paper 56.
- Hill, M.C., Tiedeman, C.R., 2007. Effective Groundwater Model Calibration: with analysis of data, sensitivities, predictions, and uncertainty. John Wiley & Sons, Inc.
- Hughes, J.D., Langevin, C.D., Chartier, K.L., and White, J.T., 2012. Documentation of the Surface-Water Routing (SWR1) Process for modeling surface-water flow with the U.S. Geological Survey Modular Ground-Water Model (MODFLOW-2005): U.S. Geological Survey Techniques and Methods, book 6, chap. A40 (Version 1.0), 113 p.
- Montgomery Watson Americas, Inc., 1999. STA-3/4 Field Investigations and Seepage Analysis. Submitted by Montgomery Watson Americas, Inc., Lake Worth, FL, to South Florida Water Management District, West Palm Beach, FL
- SFWMD (South Florida Water Management District), 2019. Central Everglades Planning Project, Post Authorization Change Report, Feasibility Study and Draft Environmental Impact Statement. Appendix A.7 – Subsurface Considerations for Construction.
- Sepúlveda, N., Tiedeman, C.R., O'Reilly, A.M., Davis, J.B., and Burger, P., 2012. Groundwater Flow and Water Budget in the Surficial and Floridan Aquifer Systems in East-Central Florida. US Geological Survey Scientific Investigations Report 2012–5161. Prepared in cooperation with the St. Johns River Water Management District, South Florida Water Management District, and Southwest Florida Water Management District.

A.10 Structural Design Criteria

This section describes the basis of structural design for new or modified facilities.

A.10.1 Applicable Codes and Standards

Design of structural elements will comply with the design codes and standards included in the Codes and Standards portion of **Section A.4**.

A.10.2 Design Stresses

A.10.2.1 Minimum Concrete Compressive Strength (Unconfined)

- Mass concrete, concrete deduction factor ($f'c$) 3,000 pounds per square inch (psi) at 28 days
- Structural concrete, $f'c$ 4,000 psi at 28 days

A.10.2.2 Reinforcing Steel

- ASTM A615, steel yield strength (f_y) 60,000 psi

A.10.2.3 Structural Steel

- Wide flange shapes, ASTM A572, Grade 50, f_y 50,000 psi
- Angles, channels, and plates, ASTM A36, f_y 36,000 psi
- Pipe sections, ASTM A53, Type E, f_y 35,000 psi
- Tube sections, ASTM A500, Type B or C, f_y 46,000 psi

A.10.2.4 Masonry

- Concrete masonry units (CMU), Grade N-1, compressive strength 1,900 psi
- Compressive strength of mortar, Type S 1,800 psi
- Compressive strength of grout 2,000 psi
- Masonry unit assembly, compression strength ($f'm$) 1,500 psi

A.10.3 Loading Criteria

A.10.3.1 Dead Loads

- Equipment Actual
- Phantom load 1 kip¹ at secondary beams and 2 kips at primary beams
- Bridge crane or monorail Actual crane beam and rail only
- Roof, superimposed Actual, 15 pounds per square foot (psf) minimum

A.10.3.2 Live Loads, per SFWMD Pump Station Engineering Guidelines, January 2021 Edition

- Roof (minimum, unreduced) 50 psf
- Floors

¹ A unit of weight equal to 1,000 pounds or 455 kilograms

○ Operating floors (non-equipment areas)	250 psf
○ Operating floors (equipment placement areas)	300 psf, or the heaviest piece of machinery anticipated to be placed therein, whichever is larger
○ Control rooms	100 psf
○ Restrooms	100 psf
○ Equipment and storage rooms	200 psf
○ Electrical and server rooms	250 psf
● Maintenance work areas	300 psf
● Stairways	100 psf
● Elevator lift and handicap ramp	200 psf
● Deck grating	250 psf
● Service bridge	LRFD HL-93 or SFWMD 44-ton, 55-ton, 60-ton, and newer truck crane loading with simultaneous 640 pounds per linear foot (plf) AASHTO distributed lane load, whichever loading is greater
● Guardrails (at top rail)	50 plf plus 200-pound concentrated load, acting in any direction
● Bridge crane runway loads:	

The bridge crane wheel loading shall be treated as a live loading for the crane runway design. The runway live load shall include the dead load of the crane plus the live load capacity of the crane. Loadings shall be positioned to produce maximum member forces and stress conditions. Additionally, design of the runway will include the dead, live, impact, longitudinal, and lateral loadings. The end stops shall be designed to stop the moving crane when fully loaded. Impact load shall be 18 percent of the crane load. The longitudinal load shall be 10 percent of the crane wheel load.

For large equipment areas, the combined weight of equipment and base plus an additional live load of 50 psf over the base area will be used as the live load.

A.10.3.3 Lateral Loads

● Active earth pressure	Conducted at 30 percent design
● At-rest earth pressure	Conducted at 30 percent design
● Passive earth pressure	Conducted at 30 percent design
● Lateral surcharge load from compaction (decreases linearly)	400 psf at the ground surface, zero psf at the depth equal to 400 psf divided by the earth pressure
● Hydrostatic	63 pounds per cubic foot (pcf)
● Vertical surcharge, at locations subject to truck or equipment loads	Surcharge shall be calculated based on the equipment listed in Section 10.3.2 , subject to a 500 psf minimum

The active pressure values will only be used for site retaining walls that are free to rotate.

A.10.3.4 Snow Loads—Not Applicable**A.10.3.5 Seismic Loads**

Earthquake loads will be considered, in accordance with the Florida Building Code, 7th (2020) edition.

A.10.3.6 Wind Loads—Pump Station

- Basic Wind Speed (Design 3-second gust wind speed) based on ASCE/SEI 7-22
- Height and exposure coefficient Exposure C
- Risk Category III
- Building type Partially enclosed

A.10.3.7 Wind Loads—Flood Control Elements

- Basic Wind Speed (Design 3-second gust wind speed) based on ASCE/SEI 7-22
- Height and exposure coefficient Exposure C
- Risk Category III
- Building type Partially enclosed

A.10.3.8 Flood Load (Hydrostatic Plus Wave)

- Dynamic Pressure Coefficient (ASCE/SEI 7-22, Table 5.4-1) 3.5

A.10.4 Hydraulic Structures and Pumping Station Substructure**A.10.4.1 Materials of Construction**

Hydraulic structures and pump stations PS-1, PS-2, and SPS-1 will be constructed of reinforced concrete. In accordance with SFWMD standards, Type II cement will be specified for these hydraulic structures and pump stations because they may be prone to sulfate attack, due to their proximity to the Kissimmee River and Lake Okeechobee. In accordance with SFWMD standards, all concrete for these hydraulic structures and pump stations, which will be below the ground surface or underwater, will have a crystalline capillary waterproofing admixture in accordance with Section 03050 of the SFWMD standard specifications.

Any platforming associated with these items will be constructed of aluminum shapes, aluminum grating, and aluminum guardrail. Connection bolts will be either stainless steel or aluminum. Reinforced concrete platforming will be used in locations where the use of grating is not appropriate.

A.10.4.2 Design Procedures and Assumptions

The structural design of the hydraulic structures and pump stations PS-1, PS-2, and SPS-1 will be based upon the loads, load combinations, load factors, and serviceability requirements contained in EM 1110-2-2104, subject to meeting the requirements of the SFWMD's latest design standards and ACI 318-19(22). Temperature and shrinkage reinforcement and cracking limits will be in accordance with ACI 350-20/350R-20.

- For reinforcement in shear, the required strength is 1.3 times the excess applied shear (V_u) less shear carried by the concrete (N_{Vc}). Thus, N_V s greater than 1.3 ($V_u - N_{Vc}$), where N_V s is the design capacity of shear reinforcement.

- Rectangular walls may be analyzed as two-way rectangular plates when the aspect ratio of length to height is 2H:1V or less. The boundary conditions will be chosen to give reasonably conservative results. If the aspect ratio exceeds 2H:1V, the wall will be designed as a one-way rectangular plate and the corners will be investigated assuming a 2H:1V ratio.
- The design of water containment walls will consider both flexure and tension in the walls. The horizontal reinforcement on the water side will be apportioned for 100 percent flexure steel plus 100 percent tension steel.
- Direct tension in the foundation and top slabs due to internal water pressure will be accounted for in the design of the slab's horizontal reinforcing. The foundation's top reinforcement will be assumed to resist 100 percent of the tension at the foundation. The tension in the top slab may be resisted equally between the top and bottom reinforcement for reasonably thin slabs.
- A minimum reinforcement for shrinkage and temperature will be provided in accordance with ACI 350-20/350R-20. As indicated in ACI 350-20/350R-20, a minimum reinforcement ratio of 0.5 percent will be provided in basin walls and base slab with a basin dimension of 50 ft or more in any direction. Reinforcement ratios in the direction where the structure dimension is less than 50 ft will be in accordance with ACI 350-20/350R-20. Minimum size of shrinkage and temperature reinforcement will be #4 and will be divided equally between the two surfaces of the concrete section. Concrete sections greater than 24 inches thick may have minimum reinforcing based on a 24-inch thickness. The shrinkage and temperature reinforcement in the bottom of slabs reinforced top and bottom, in contact with the subgrade, can be reduced to one-half the values calculated.
- Hydrostatic groundwater pressure for structures adjacent to the reservoir will be based on the water level of the reservoir. In accordance with Corps EM 1110-2-2104, the uplift pressure distribution along the base of foundations will be assumed to be linear between the upstream and downstream edges of the foundation. The pressure distribution will be modified to take into account any foundation drains or groundwater cutoff devices. Uplift reduction at drains may not exceed 50 percent of the difference between the full uplift head at the pump station intake and the drain.
- Earthquake loads will be considered, in accordance with the Florida Building Code, 8th (2023) edition.
- Steel hydraulic structures will be designed in accordance with Corps EM-1110-2-2107 and the *AISC Steel Construction Manual*, 16th edition.

A.10.5 Building Structures

Building structures, excluding structural concrete, will be designed based upon the loads, load combinations, load factors, and serviceability requirements contained in the Florida Building Code, 8th (2023) edition. Structural concrete design will be in accordance with the SFWMD's latest design standards and ACI 318-19(22). The additional concrete design requirements of ACI 350-20/350R-20 and EM1110-2-2104 will not be considered applicable for building structures unless exposed to water, wastewater, or aggressive chemicals, such as saltwater. Additionally, building structures and their components that are subject to equipment impact and vibration will be designed in accordance with the applicable recommendations of ACI 350.4R-04, subject to engineering judgment.

Lateral wind loads will be transferred to the foundation from their origin in a rational manner. The horizontal distribution of wind loads will be based upon the assumption that the roof/floor diaphragms are both rigid and flexible for steel deck diaphragms and rigid for cast in place or precast concrete diaphragms. Where the diaphragm is assumed to behave in a flexible manner, the wind lateral load distribution will be based upon the tributary area to the resisting elements. Where the diaphragm is assumed to behave as a rigid panel, the wind lateral load distribution is based on the relative rigidities of the resisting elements.

A.10.6 Inspection Requirements

Inspection will be required per the Florida Building Code, 8th (2023) edition, Chapters 1 and 17.

A.10.7 Bridges

A bridge (BR-1) will be constructed to carry traffic on the north levee road of C-41A over the reservoir inflow-outflow canal (CNL-2). The bridge will consist of a reinforced concrete slab superstructure, supported on two end bents and intermediate bents. Each of the end and intermediate bents will consist of square prestressed concrete piles with reinforced concrete cap beams.

The bridge configuration under any conditions should maintain a minimum of 2 ft of freeboard above the design high water level of the C-41A Canal and the Reservoir East Inflow-Outflow Canal (CNL-2).

The Bridge Analysis Report and Location Hydraulic Report for the bridge development process have not been completed. Completion of these reports will be made upon approval of the reservoir inflow-outflow canal (CNL-2) location, size, and design. The bridge (BR-1) will be designed in accordance with the AASHTO LRFD Bridge Design Specifications, 9th edition. The bridge will be designed for LRFD HL-93 loading or SFWMD 44-ton, 55-ton, 60-ton, and newer truck crane loading with simultaneous 640 plf AASHTO distributed lane load, whichever loading is greater.

A.11 Site Civil Design

A.11.1 Project Layout

As shown in the planning level civil engineering design drawings in **Annex C-1**, the site plan of the reservoir for the Recommended Plan was designed so that the reservoir would fit within the limits of the existing pasture area within the southern part of the Basinger Tract, while minimizing impacts to the existing citrus fields within the northern part of the Basing Tract, and adhere to the geometrical requirements for reservoir dam embankments, toe ditches, toe roads, perimeter (i.e., seepage) canals, and perimeter maintenance roads in DCM-4. The reservoir site, which includes the reservoir and its external features, including its perimeter canal, perimeter maintenance road, east inflow-outflow canal, and west inflow-outflow canal, would encompass an area of approximately 12,554 ac outside of the C-41A right-of-way, of which the reservoir would occupy an area (within the centerline of its perimeter dam) of approximately 11,320 ac. At its NFSL of 51.7 ft NAVD88, the reservoir would have an average storage depth of approximately 18 ft within each of its two storage cells since the average ground surface elevation within the storage cells is 33.9 ft NAVD88. **Table A.11-1** shows the calculated storage volume at the NFSL.

Table A.11-1. Reservoir Stage Storage.

Stage (ft-NAVD 88)	Stage Description	West Cell Water Surface Area (ac)	West Cell Cumulative Water Storage ^{2/} (ac-ft)	East Cell Water Surface Area (ac)	East Cell Cumulative Water Storage ^{3/} (ac-ft)	Combined Cumulative Water Storage (ac-ft)
71.64	Interior Top of Bank of Elevation of Perimeter Dam Crest	4,766	182,102	6,526	247,640	429,742
51.70	NFSL	4,701	87,608	6,453	118,102	205,710
22.90	Approximate Lowest Ground surface Elevation within Each Reservoir Cell	0	0	0	0	0

1/ ac–acre; ac-ft–acre-foot; ft–foot; NAVD88–North American Vertical Datum of 1988; NFSL–Normal Full Storage Level

2/ Includes the estimated storage capacity within the West Cell borrow area of 2,893 ac-ft.

3/ Includes the estimated storage capacity within the East Cell borrow area of 3,311 ac-ft.

The site plan of pump station PS-1 and spillway S-84+ for the Recommended Plan was designed so that these structures could be constructed within the existing right-of-way of C-41A, through a sequence of construction that would not interrupt the SFWMD’s C-41A flood control and water supply operations (as described in **Subsection A.3.3.5**), while adhering to the SFWMD’s standard engineering design guidelines for pump stations and spillways.

A.11.2 Impacts to C-41A Levees and Required Section 408 Approval

As shown on the overall site plan and cross-sections of structures for the Recommended Plan, in **Annex C-1**, the Project includes the construction of canals and structures at the reservoir site with hydraulic connections to C-41A, which will penetrate the levee along the north side of C-41A. Also, the construction of S-84+ and PS-1 (which includes the demolition of S-84 and S-84X) will include work that interfaces with the existing Herbert Hoover Dike along the north and south sides of C-41A. The temporary impacts to these levees during construction and the permanent modification of these levees resulting from the construction of these Project components will require that the flood protection provided by these existing

levees is properly maintained during construction, and that SFWMD obtains a Section 408 approval from the Corps for these levee impacts, during the PED phase of the Project, before starting construction of these Project components.

A.11.3 Site Access, Roadways, and Bridges

General access to the reservoir and its structures will be limited to SFWMD staff and their guests. Public access to the reservoir will only be allowed through designated public access points, as described in **Appendix F**. Public access locations will be designed to support nature-based recreation in accordance with SFWMD standards. Access to PS-1 and S-84+ will be limited to SFWMD staff and their guests.

Section A.17 provides a description of the permanent access features and roadways to be constructed as part of the Project. The reservoir perimeter and divider dams are designed to have a crest width of 18 ft with a stabilized surface to allow for vehicular traffic along the crest, with access ramps and pullout areas (for turnaround and passing maneuvers) provided at the required intervals per DCM-4. **Section A.10.7** provides a description of proposed bridge, BR-1, along the C-41A north levee road that would span across the reservoir inflow-outflow canal. **Subsection A.3.3.2** provides a description of the site access to be used during construction.

A.11.4 Stormwater Control/Site Drainage

A.11.4.1 During Construction

As explained in **Section A.3.3.6**, the size and nature of the Project, and the existing drainage conditions within and around the reservoir site require that stormwater be managed during construction, to reduce the likelihood during construction of drainage impacts to offsite properties that historically drain to the reservoir site; and to reduce the likelihood of construction delays caused by flooded conditions within and around the reservoir site. Maintenance of existing agricultural drainage facilities within the reservoir site during construction, including the need for the LOCAR construction contractors of contracts 3, 4, 5, and 6 to submit a Stormwater Management During Construction Plan to SFWMD for review and approval is discussed in **Section A.3.3.6**.

A.11.4.2 Permanent Construction

The site grading around the reservoir pump stations, PS-2 and SPS-1, as well as pump station PS-1 and spillway S-84+, will include provisions for capturing and treating, where necessary, stormwater runoff. As shown in **Sections A, B, and C** in **Annex C-1**, the exterior of the reservoir perimeter dam will include a grassed toe ditch with a bottom width of 8 ft and 3H:1V and 4H:1V side slopes that will collect runoff from the exterior side slope of the reservoir perimeter dam and convey it to drainage culverts spaced every 1,000 ft that will discharge to the reservoir's perimeter canal. The design of the stormwater management system for each of the Project's facilities, prepared during the PED phase, will comply with local and state guidelines and regulations.

A.11.5 Utilities

A.11.5.1 Electric Power

There are existing utilities poles with overhead electrical power lines within the Basinger Tract that run parallel to the east side of Reaches 3B through 6 of the proposed reservoir perimeter canal (CNL-1), located along the east side of the reservoir's east storage cell. The utility poles are located approximately

75 to 80 feet west of the Basinger Tract east property boundary; therefore, they are located approximately 0 to 12 feet from the east top of bank of Reaches 3B through 6 of the perimeter canal.

A description of other existing electric power utilities at/near the Project site is provided in **Subsections A.13.1.1** and **A.13.1.2**; and are shown on a map in **Annex E-1**.

A.11.5.2 Other Utilities

The Project includes features that will be constructed within and adjacent to the C-41A ROW. Therefore, a review of existing SFWMD ROW permits for C-41A was performed. **Table A.11-2** provides a summary of the existing SFWMD ROW permits for utilities within the C-41A r ROW that are adjacent to the Project’s limits of construction.

Table A.11-2. SFWMD ROW Permits for Utilities within the C-41A ROW Adjacent to the Project’s Limits of Construction.

Permit No.	Permittee	Year Issued	Description of Utility with C-41 ROW
3057	Glades Electric Cooperative	1966	Aerial crossing of electrical wires over C-41A approximately 1 mile east of C-41
13561	Florida Gas Transmission Co.	2010	Subaqueous crossing of 30-inch diameter steel gas pipeline under C-41A approximately 308 ft north of SR 70 centerline
1465	Florida Power & Light	2017	Aerial crossing of electrical wires over C-41A approximately 150 ft north of SR 70 centerline
12019	Florida Power & Light	2003	Aerial crossing of electrical wires over C-41A approximately 425 ft west of S-84

ft-foot; Project–Lake Okeechobee Storage Reservoir Section 203 Study; ROW–right-of-way; SFWMD–South Florida Water Management District; SR–State Route

The 30-inch diameter steel gas pipeline referenced in **Table A.11-2** (Permit No. 13561) was installed within a 50-foot-wide permanent easement, located within the Basinger Tract, as shown in the easement documentation and as-built drawings for this easement and pipeline included in **Annex C-2**. As shown in **Figure A.11-1**, the southeast limit of the construction boundary for the reservoir site (displayed as a green boundary) is located along the northwest/north boundary of this easement (highlighted in magenta).

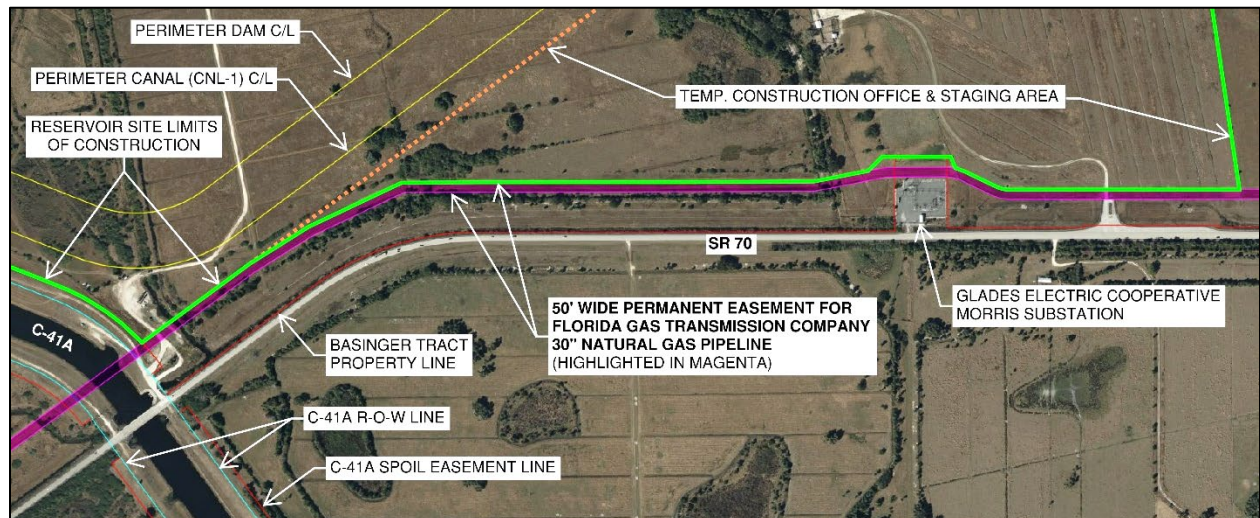

Figure A.11-1. Florida Gas Transmission Company Permanent Easement.

A.11.5.3 Relocation of Utilities

Based upon a review of the existing utilities identified in **Section A.11.5**, the Project will require the relocation of some or all of the existing 26 utility poles and their overhead electrical wires along the east side of the reservoir's east storage cell (described in **Section A.11.5.1**), as part of the construction of Reaches 3B through 6 of the reservoir perimeter canal (CNL-1).

In addition, the Project will require the relocation of the existing overhead and underground electrical service lines that provide electrical power to S-84 and S-84X (described in **Section A.11.4.2**), as part of the demolition of S-84 and S-84X, for the construction of S-84+ and PS-1.

During the PED phase, an updated, comprehensive review of existing utilities within and adjacent to the Project limits of construction will be performed to confirm if any other utility relocations are required for the construction of the Recommended Plan. Coordination for the relocation of any existing utilities will be performed with the appropriate utility companies during the PED phase, to ensure that the relocation of utilities does not cause any delays in the construction of the Recommended Plan.

A.12 Mechanical Design

A.12.1 Introduction

This section describes the preliminary design of the proposed pump stations which will serve as the inflow pump stations and seepage pump station for the reservoir. The PS-1 Lake Okeechobee pump station will be located adjacent to the S-84+ spillway, and pump from the C-41A Canal on the east side of S-84+ into the C-41A Canal on the west side of S-84+. The PS-2 reservoir inflow pump station will be located between the reservoir east cell, and the C-41A Canal, west of State Road 70. The reservoir Inflow-Outflow Canal will connect the C-41 Canal to the PS-2 pump station intake. PS-2 will serve as a lifting facility, raising water from the C-41A Canal to the east cell of the reservoir. Seepage outflow from the reservoir will be captured in the reservoir Perimeter Canal, which will convey the seepage outflow to the SPS-1 seepage pump station, which will pump from the Perimeter Canal to the east cell of the reservoir. This section covers the pump stations, approach channel and discharge force mains to the reservoir. PS-1 and PS-2 will each have a maximum design pumping capacity of 1,500 cfs. SPS-1 will have a maximum design pumping capacity of 100 cfs.

A.12.2 Pump Station

A.12.2.1 Design Criteria

The total design pumping capacity of PS-1 is 1,500 cfs. PS-1 is proposed to be an electric motor driven pump station. The total design pumping capacity of PS-2 is 1,500 cfs, for delivering flows from the C-41A reach between S-83 and S-84. The reservoir is not considered a flood control facility so the main pump station pumps, are electric motor driven. For purposes of the feasibility study and because this environmental restoration project, these pumps are proposed to be electric powered as the regional modeling indicates the reservoir will normally be close to filled towards the end of the wet season. Fitting these pump stations with backup generation capacity for the large motors is not considered cost effective.

The SPS-1 reservoir seepage pump station however could be fitted with a diesel back-up to provide some level of flood event pumping in the event of an extreme storm and could receive runoff from the adjacent farms and pull from Lake Istokpoga to relieve some flooding in the event of a prolonged power outage. During the final design a determination of the pump mix (sizes and whether electric vs diesel, etc.) to determine the appropriate approach to achieving the final pumping capacity. Evaluation would be based on long term costs to construct, operate and maintain, reliability of the electric grid in the area to handle the loads, etc. Generator backup for some of the (seepage) pump capacity may be warranted to meet the project purpose. The PS-1, PS-2, and SPS-1 pump stations may not be staffed during a storm event. Each pump station will include intake trash racks to screen inflows and protect their pumps from damage.

The PS-1 and PS-2 pump stations will be equipped with ventilation, air conditioning in electrical spaces and personnel areas. A potable water and sanitary waste system will also be provided. A unisex restroom with shower facilities will be provided. The SPS-1 pump station will be equipped with ventilation, in electrical spaces and personnel areas.

Figure A.12-1 and **Figure A.12-3** show a site plan for each pump station; and **Figure A.12-2**, **Figure A.12-4**, **Figure A.12-5**, and **Figure A.12-6** show a section through one of the intake bays and corresponding discharges pipes for each pump station. These drawings are also included in **Annex C-1**.

A.12.2.2 Equipment**PS-1**

-
- | | |
|--|------------------------------------|
| • Pump Station Capacity: | • 1,500 cfs |
| • Number of Pumps/Bays: | • 4 |
| • Pump Capacity: | • Four (4) Units - 375 cfs |
| • Motor Horsepower | • 1,600 Hp |
| • Design Static Head, Min/Max: | • 5.3 feet / 14.2 feet |
| • Discharge Pipe Invert at High Point: | • 26.0 ft NAVD88 |
| • Pump Intake Low Level Shut-off | • 13.25 ft NAVD88 |
| • Pump Configuration: | • Vertical, Wet Pit, Mixed Flow |
| • Pump Intake: | • Formed Suction Intake (FSI) |
| • Pump Driver (375 cfs): | • Electric Motor Direct Drive |
| • Discharge Configuration: | • 78" Steel Pipe with flap gates |
| • Trash Racks: | • Mechanically Cleaned Bar Screens |
| • Rack Bar Spacing: | • 3 inches |

PS-2

-
- | | |
|--|---|
| • Pump Station Capacity: | • 1,500 cfs |
| • Number of Pumps/Bays: | • 4 |
| • Pump Capacity: | • Four (4) Units - 375 cfs |
| • Motor Horsepower | • 2,700 Hp |
| • Design Static Head, Min/Max: | • 1 foot / 28.6 feet |
| • Discharge Pipe Invert at High Point: | • 59.50 ft NAVD88 |
| • Pump Intake Low Level Shutoff | • 21.5 ft NAVD88 |
| • Pump Configuration: | • Vertical, Wet Pit, Mixed Flow |
| • Pump Intake: | • Formed Suction Intake (FSI) |
| • Pump Driver (375 cfs): | • Electric Motor Direct Drive |
| • Discharge Configuration: | • 78" Steel Pipe over reservoir dam to submerged outlet |
| • Trash Racks: | • Mechanically Cleaned Bar Screens |
| • Rack Bar Spacing: | • 3 inches |

SPS-1

-
- | | |
|--|---|
| • Pump Station Capacity: | • 100 cfs |
| • Number of Pumps/Bays: | • 3 (includes one 50 cfs auxiliary seepage pump) |
| • Pump Capacity: | • Two (2) Units - 50 cfs |
| • Motor Horsepower | • 300 Hp |
| • Design Static Head, Min/Max: | • 1 foot / 28.6 feet |
| • Discharge Pipe Invert at High Point: | • 59.50 ft NAVD88 |
| • Pump Intake Low Level Shutoff | • 23.5 ft NAVD99 |
| • Pump Configuration: | • Vertical, Wet Pit, Mixed Flow |
| • Pump Intake: | • Formed Suction Intake (FSI) |
| • Pump Driver (130 cfs): | • Electric Motor Direct Drive |
| • Discharge Configuration: | • 36" Steel Pipe over reservoir dam to submerged outlet |
| • Trash Racks: | • Mechanically Cleaned Bar Screens |
| • Rack Bar Spacing: | • 3 inches |

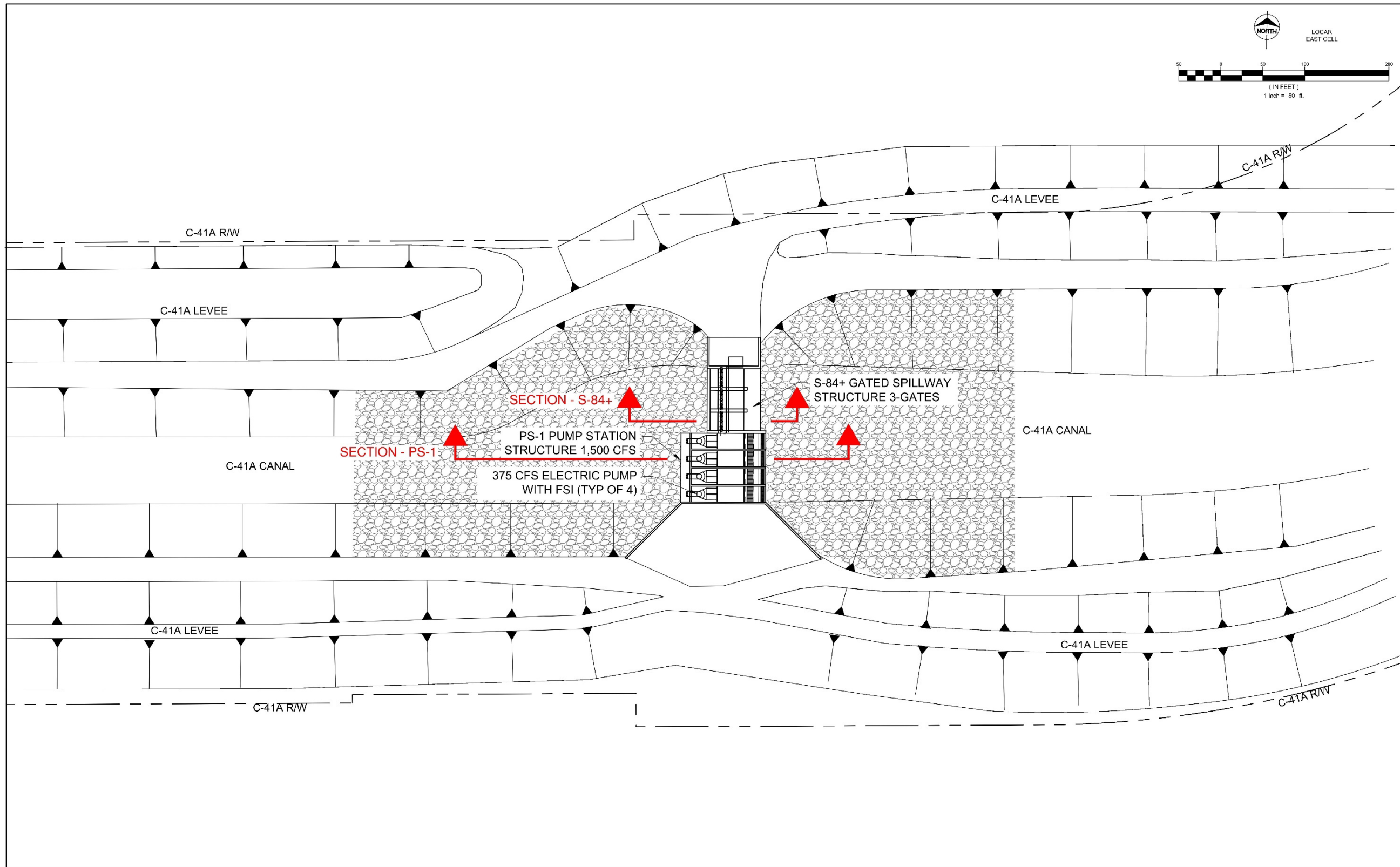

Figure A.12-1. PS-1 Pump Station and S-84+ Spillway Site Plan.

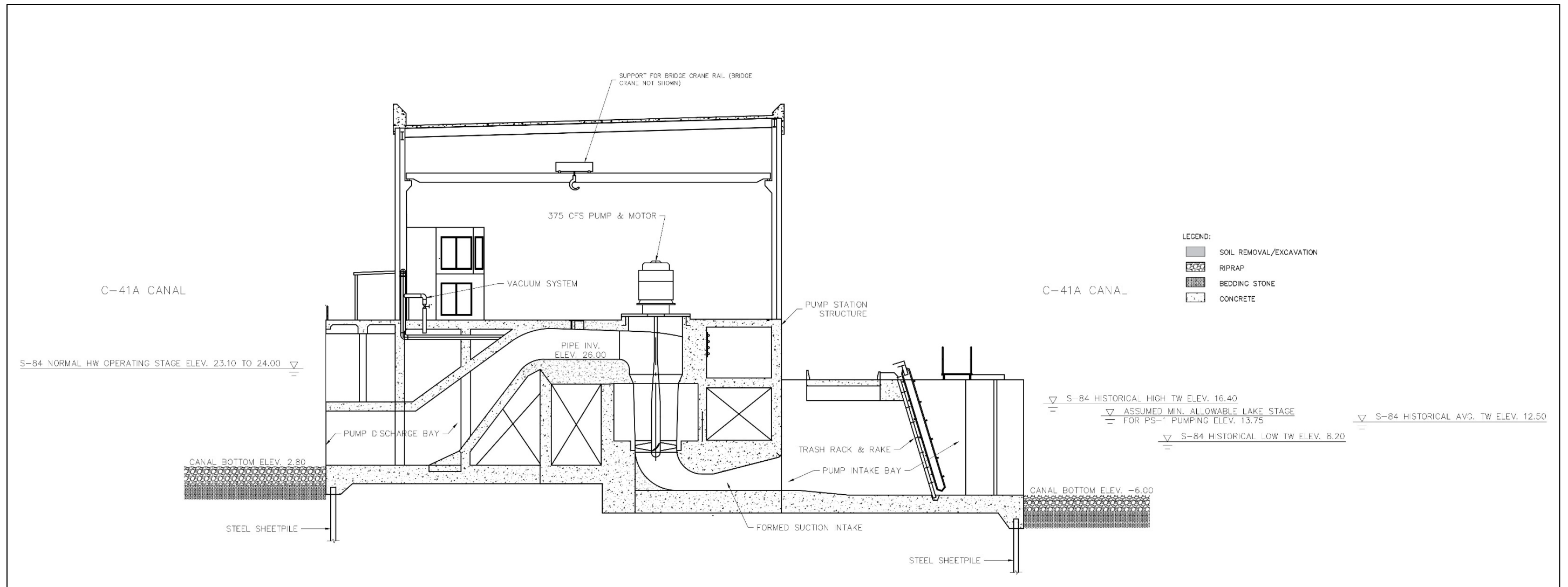

Figure A.12-2. PS-1 Pump Station Section.

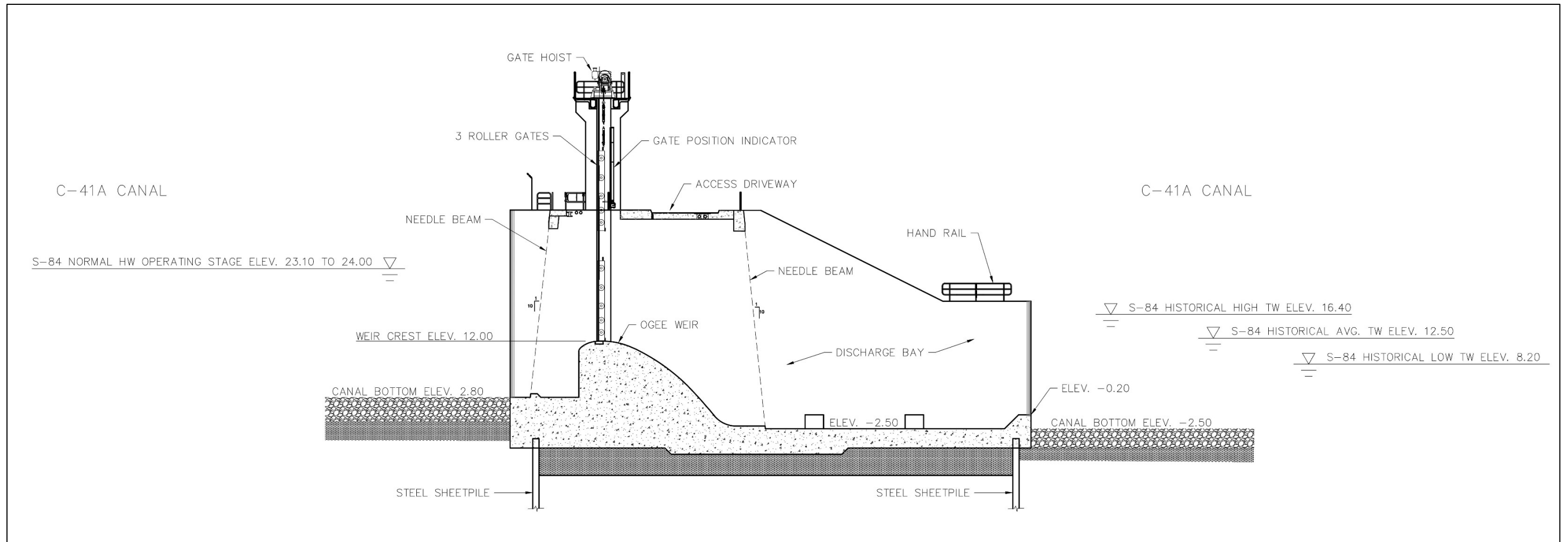

Figure A.12-3. S-84+ spillway section.

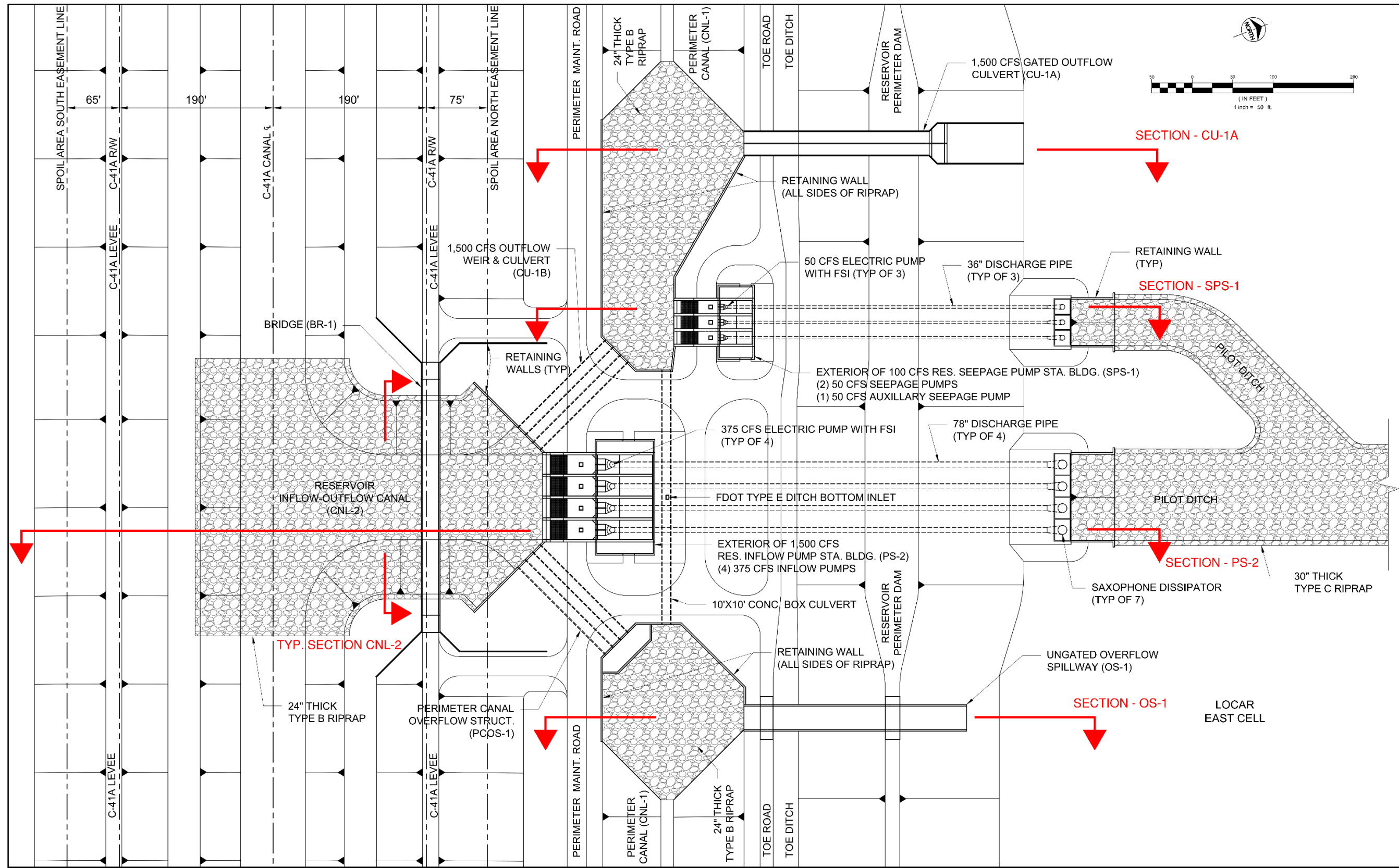

Figure A.12-4. PS-2 Pump Station and SPS-1 Pump Station Site Plan.

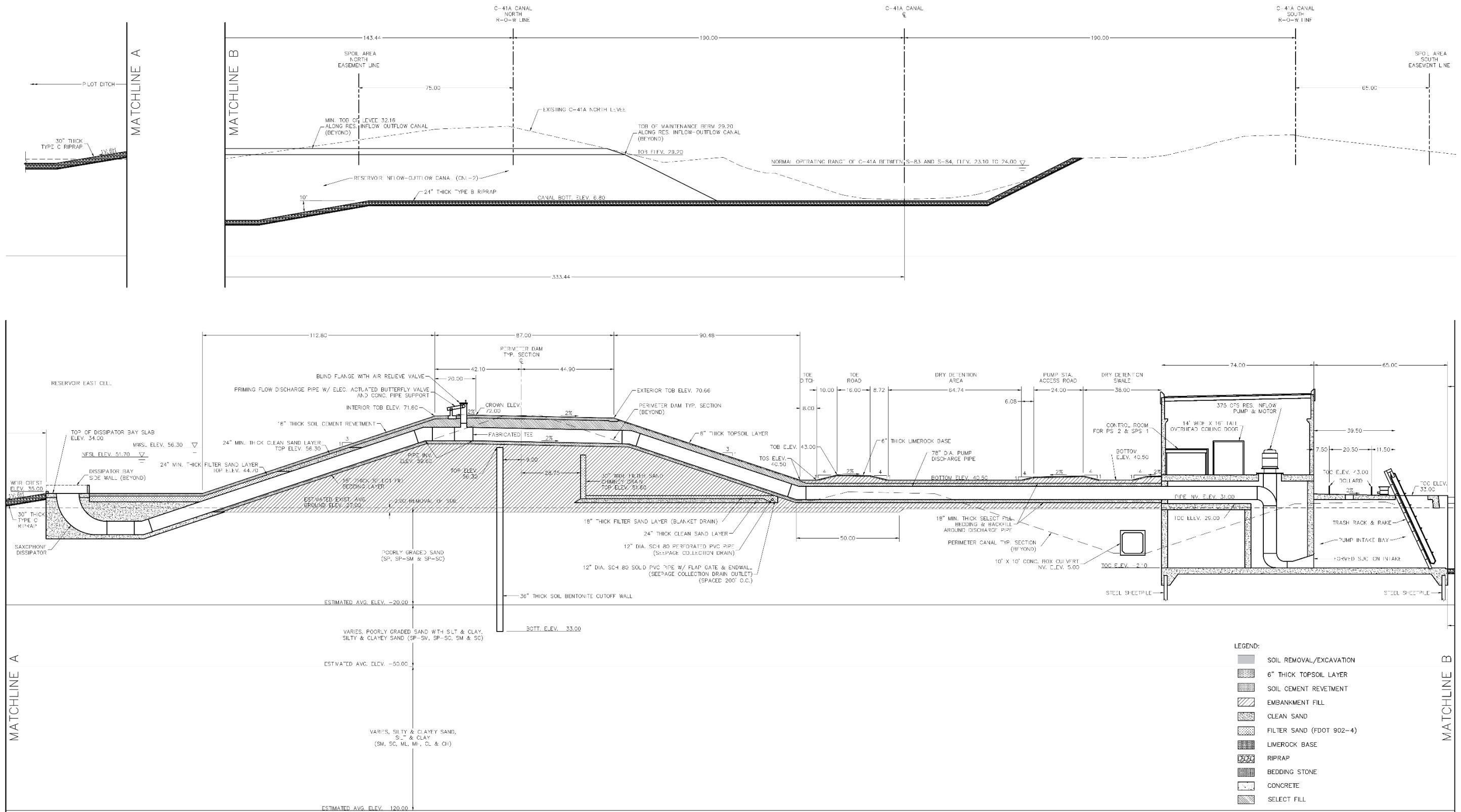

Figure A.12-5. PS-2 Pump Station section.

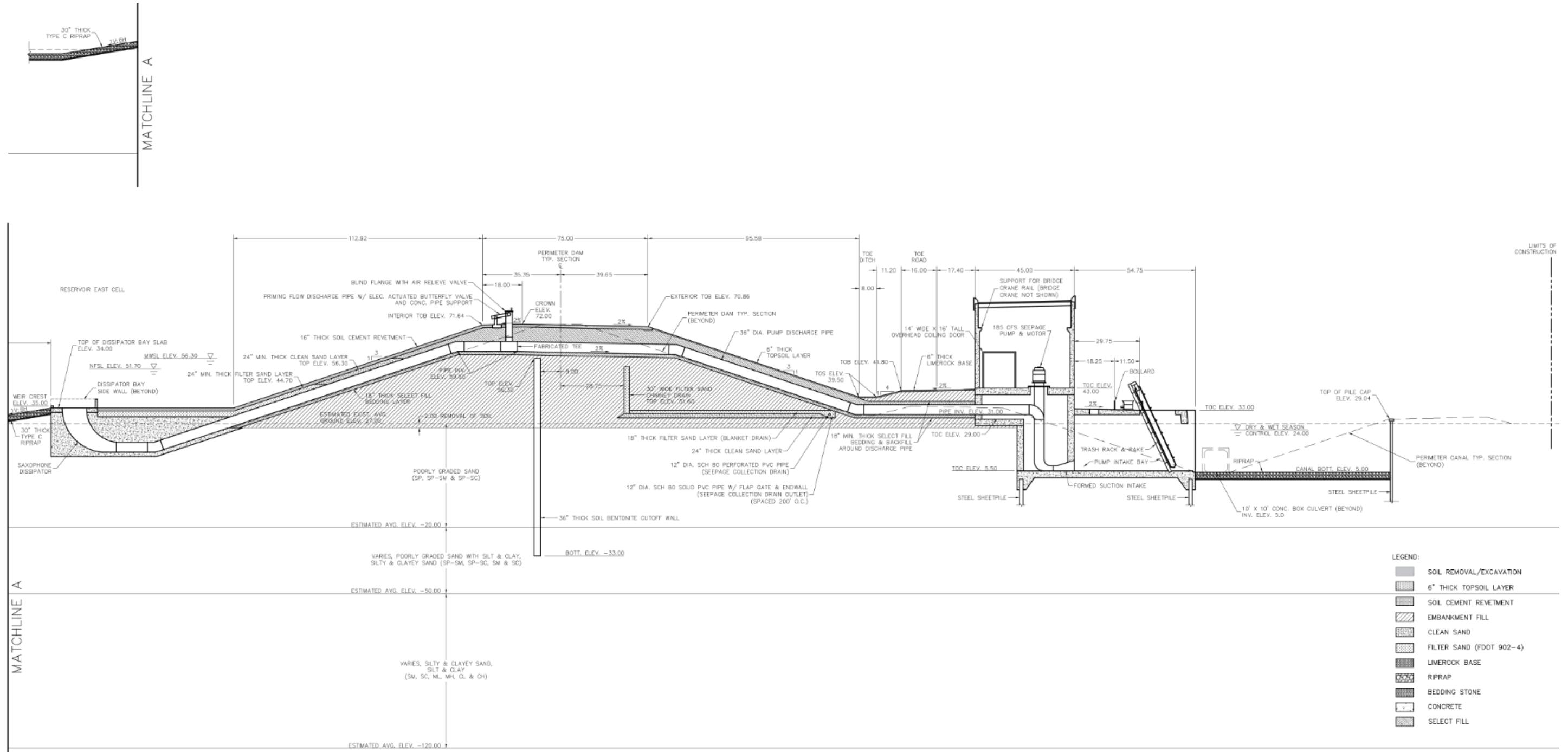

Figure A.12-6. SPS-1 Pump Station section.

A.12.2.3 Protection Elevation

The operating floor and control room floor elevation at each pump station should limit the possibility of flood damage to the pump, electrical and ancillary mechanical equipment. Therefore, the operating floor and control room floor elevation for the PS-1, PS-2 and SPS-1 pump stations should be at or above the highest elevation from the following criteria:

- Minimum finished floor elevation (FFE) required in the latest edition of the Florida Building Code
- Minimum FFE required for a Flood Design Class 4 building/structure in ASCE 24-14 Flood Resistant Design and Construction
- Minimum FFE required in the Federal Flood Risk Management Standard (FFRMS), as authorized under Federal Executive Orders 13990 and 14030
- Other minimum FFE standards/criteria determined during the PED phase of the Project
- One foot above the peak flood stage within the pump station site and its stormwater management system that would theoretically occur with zero stormwater discharge from the pump station site and its stormwater management system during the 500-year, 3-day design storm
- Four feet above the historical maximum stage within the segment of the C-41A Canal between S-83 and S-84

In addition, the operating floor and control room floor elevation for the PS-2 and SPS-1 pump stations should be at or above the following stage:

- Four feet above the 100-year, 3-day design storm maximum stage of Reach 7 of the reservoir Perimeter Canal

The PS-2 and SPS-1 pump stations, which discharge into the east cell of the reservoir, use an over-the-embankment discharge configuration for backflow prevention. The required minimum invert elevation of the discharge pipes over the reservoir dam embankment to ensure backflow prevention is the maximum water surface level (MWSL) of the reservoir cell (where the pump station discharge pipes terminate) + maximum wind setup of the reservoir cell (where the pump station discharge pipes terminate) + 2 feet of freeboard.

Therefore, the PS-2 and SPS-1 over-the-embankment discharge configuration, pipe invert, high point elevation is 59.60 ft NAVD88 for the PS-2 and SPS-1 pump stations. As described in **Section A.5**, to ensure that the wave overwash rate for the reservoir perimeter dam is kept within an acceptable limit, the top of the proposed perimeter dam is set at elevation 72.00 ft NAVD88, which is 39 feet above the average existing grade elevation at the PS-2 and SPS-1 pump station site of 27.00 ft NAVD88. Clearances necessary for below the base plate pump discharge and its coupling may be the critical dimension and must be coordinated with the pump manufacturer.

A.12.2.4 Reservoir Inflow-Outflow Canal Considerations for PS-2

The reservoir Inflow-Outflow Canal will connect to the C-41A Canal at 90 degrees and proceed north to the PS-2 pump station, crossing through the existing berm and levee on the north side of the C-41A Canal. The Inflow-Outflow Canal will be in line with the intake centerline of the pump station intake. The flow approaching the pump intake should ideally be steady and uniformly distributed both laterally and

vertically. It should also be noted, a surface drop can occur across a partially blocked trash rack, or whenever the pumps have lowered the water level in the sump to the point at which all pumps are about to be switched off.

A.12.2.5 Mechanical Arrangement Considerations

The mechanical design of each pump station includes pumps, drivers and appurtenances necessary to provide a functional and reliable system. The conceptual design is intended to provide satisfactory hydraulic configuration, good working access around equipment, crane access to systems and to vehicles. The design is intended to follow the latest edition of the SFWMD Pump Station Engineering Guidelines and DCM-5. The flow to the pump stations is taken from the C-41A Canal, Perimeter Canal, or the reservoir Inflow-Outflow Canal, with a screened approach to the individual pumps at each station.

A.12.2.6 System Analysis of Pump Stations

System Design Requirements

The design of systems and selection of appropriate components for pump stations PS-2 and SPS-1 is based on Corps EM 1110-2-3105, the SFWMD Pump Station Engineering Guidelines, and DCM-5. The pump design must account for the range of static head generated by the elevation in the supply canal and the reservoir from empty to full for PS-2 and SPS-1, or the range in stages within the C-41A Canal on upstream side of S-84+ for PS-1. Compared to most facilities the static head represents a wide range in the South Florida region. The result of the combination of friction and static head variations represents a challenge for vertical wet pit axial or mixed flow pumps. The design of pump stations PS-2 and SPS-1, includes a high point in the discharge piping that will preclude backflow to the supply canal from the reservoir. This presents a starting condition that the pumps and motors must be able to overcome before a siphon is established to reduce the operating head. This determines the pump design condition and the horsepower required of the motor for successful operation. In addition, it is desired that the pumps operate within an “Acceptable Operating Range” as previously defined by the Hydraulic Institute in Section 9.6.

System Analysis

PS-1 pump station’s static head design conditions are a function of the current operating levels in the C-41A Canal on the upstream and downstream side of S-84. Head conditions for the PS-2 and SPS-1 pump stations are a function of the levels in the C-41A Canal and the reservoir east cell. **Table A.12-1** summarizes the canal and reservoir range of elevation conditions. Additionally, head conditions were increased by 0.5 feet on the pump intake side to account for losses through the condition of a partially blocked trash rack. Pumps will be shut down if losses through trash rack exceed 0.5 ft.

The maximum static head at PS-1 is based on the minimum canal stage of 13.75 ft NAVD88 in C-41A downstream of S-84 (based on the assumed minimum Lake Okeechobee stage of 13.75 ft NAVD88 less 0.5 feet for partially block trash rack, for PS-1 pumping operations), and a maximum elevation of 24.0 ft NAVD88 in C-41A upstream of S-84 (see **Table A.12-2**). Maximum static head over the hump is based on water elevation in the discharge pipe when 2/3 full and 0.5 ft loss in trash rack. Minimum static head is based on maximum stage of 16.4 ft NAVD88 in C-41A downstream of S-84, and a minimum stage of 23.1 ft NAVD88 in C-41A upstream of S-84. The invert of the pump discharge tube is 26 ft NAVD88. Pump intake low-level shutoff will be 13.75 ft NAVD88 upstream of trash rack.

Table A.12-1. Pump Station Canal and Reservoir Conditions.

C-41A Downstream Side of S-84 Max. Canal Stage (ft NAVD88)	C-41A Downstream Side of S-84 Min. Canal Stage for Pumping (ft NAVD88)	C-41A Upstream Side of S-84 Max. Canal Stage (ft NAVD88)	C-41A Upstream Side of S-84 Min. Canal Stage (ft NAVD88)	Reservoir East Cell Max. Stage (NFSL) (ft NAVD88)	Reservoir East Cell Min. Stage (Empty) (ft NAVD88)	Pump Discharge Pipe Invert at High Point over Res. Dam (ft NAVD88)
16.4	13.75	24.0	23.1	51.7	27.0	59.60

Table A.12-2. PS-1 Pump Station Static Head.

Max. Static Head with Siphon (ft)	Min. Static Head with Siphon (ft)	Max. Static Head Over Hump (ft)	Pipe Invert at High Point (ft NAVD88)
10.75	6.7	17.1	26.0

Max conditions include 0.5 ft loss through trash rack, Over hump has 78" diameter pipe 2/3 full = 4.3 ft, Critical depth $Y_c = 5.0$ at 330 cfs startup

The maximum static head at PS-2 is based on the minimum Inflow-Outflow Canal stage of 22 ft NAVD88 less 0.5 feet for partially blocked trash rack, the reservoir NFSL or pump shut-off elevation of 51.70 ft NAVD88 and a siphon in the pump discharge (**Table A.12-3**). Maximum static head over the hump is based on water elevation in the discharge pipe when 2/3 full. The minimum static head is surface of canal to dissipator weir in the reservoir during empty conditions and with a siphon established. The discharge dissipator pad will have a weir crest with a minimum elevation of 35 ft NAVD88 to limit siphon recovery and evenly distribute the pump discharge. Pump intake low-level shutoff will be 22.0 ft NAVD88 upstream of trash rack.

Table A.12-3. PS-2 Pump Station Static Head.

Max. Static Head with Siphon (ft)	Min. Static Head with Siphon (ft)	Max. Static Head Over Hump (ft)	Reservoir NFSL (ft NAVD88)	Pipe Invert at High Point (ft NAVD88)
30.2	11.0	42.4	51.7	59.60

Max conditions include 0.5 ft loss through trash rack, Over hump has 78" diameter pipe 2/3 full = 4.3 ft, Critical depth $Y_c = 4.8$ at 330 cfs startup

The maximum static head at SPS-1 is based on the control elevation of 24 ft NAVD88 for Reach 7 of the Perimeter Canal less 0.5 feet for partially blocked trash rack, the reservoir NFSL or pump shut-off elevation of 51.70 ft NAVD88 and a siphon in the pump discharge (**Table A.12-4**). Maximum static over the hump is based on water elevation in the discharge pipe when 2/3 full. The minimum static head is surface of the canal and dissipator weir when the reservoir is empty conditions and with a siphon established. The discharge dissipator pad will have a weir crest with a minimum elevation of 35 ft NAVD88 to limit siphon recovery and evenly distribute the pump discharge. Pump intake low-level shutoff will be set at 24.0 ft NAVD88 upstream of trash rack.

Table A.12-4. SPS-1 Pump Station Static Head.

Max. Static Head with Siphon (ft)	Min. Static Head with Siphon (ft)	Max. Static Head Over Hump (ft)	Reservoir NFSL (ft NAVD88)	Pipe Invert at High Point (ft NAVD88)
28.2	9	38.1 (for 3' diameter pipe)	51.7	59.6

Max conditions include 0.5 ft loss through trash rack, Over hump has pipe 2/3 full = 2 ft, Critical depth $Y_c = 2$ at startup

Table A.12-5. Fitting Friction Factors (K).

FSI	90° Elbows	45° Elbows	Increaser	Outlet Loss
K = 0.15	K = 0.30	K = 0.23	K = 0.52-0.63 Variable	K = 1.0

Friction losses are calculated based on a fitting-specific factor (K) multiplied by the velocity head in that fitting. Velocity head is computed by the formula:

$$V_h = V^2 / 2 * g$$

Where: V_h is the velocity head for that pipe/fitting diameter

V is the velocity based on flow and diameter

g is the acceleration of gravity (32.2 ft/sec²)

For initial calculations, the outlet loss has been assumed as a square outlet, which is a worst case. This will be revised to a "Saxophone Outlet" when pump information is received and reviewed. The K factor for the increaser is calculated based on specific geometry and the ratio of diameters. Pipe flow losses are computed assuming full pipe flow, using the Williams and Hazen formula. This formula, solved for head loss per thousand feet, is:

$$s = \left[\frac{v}{c * r^{0.63} * 0.001^{-0.04}} \right]^{1.85}$$

Where: s is head loss

v is velocity

c is the roughness coefficient

r is the hydraulic radius (D/4 for round conduits flowing full)

Table A.12-6. PS-1 Friction Losses at Maximum Capacity.

Capacity (cfs)	Velocity (fps)		FSI Entrance (ft) [1 ea]	78" 90° Elbow (Ft) [2 ea]	78" Outlet Loss (ft) [1 ea]	78" Pipe Loss (ft)	Total (ft)
375	11.3		0.3	0.91	1.98	0.32	3.52

Table A.12-7. PS-2 Friction Losses at Maximum Capacity.

Capacity (cfs)	Velocity (fps)	FSI Entrance (ft) [1 ea]	78" 90° Elbow (Ft) [1 ea]	78" 45° Elbow (ft) [5 ea]	78" Outlet Loss (ft) [1 ea]	78" Pipe Loss (ft)	Total (ft)
375	11.3	0.3	0.59	2.74	1.98	2.14	7.75

Table A.12-8. SPS-1 Friction Losses at Maximum Capacity.

Capacity (cfs)	Velocity (fps)	FSI Entrance (ft) [1 ea]	36" 90° Elbow (ft) [1 ea]	36" 45° Elbow (ft) [5 ea]	36" Outlet Loss (ft) [1 ea]	36" Pipe Loss (ft)	Total (ft)
50	7.1	0.25	0.59	1.07	0.78	2.21	4.41

Based on the information above, the friction losses are less than maximum static head, and particularly the dry starting head. In addition, the minimum head when the reservoir is empty presents an extreme range for the pumps to handle.

Pump Performance Requirements

Table A.12-9. Pump Design Capacity at Rated Conditions (Running).

Pump Station	Capacity (cfs/GPM)	Velocity Head (ft)	Static Head (ft)	Friction Head (ft)	Pump Losses (ft)	Total Head (ft)	HP
PS-1	375/170,000	2.0	11.0	3.52	2.5	19.0	1,130
PS-2	375/170,000	1.9	20.6	7.75	2.5	32.6	1,900
SPS-1	50/22,500	0.8	20.0	4.58	2.5	27.9	260

Note: Above values based on operation with siphon in effect, pump and motor efficiency included in HP

Table A.12-10. Pump Design Capacity at Rated Conditions (Starting)

Pumps	Capacity (cfs/gpm)	Velocity Head (ft)	Static Head (ft)	Friction Head (ft)	Pump Losses (ft)	Total Head (ft)	HP	Use HP
PS-1	360/163,000	1.8	17.1	3.19	2.5	24.6	1,280	1,600
PS-2	320/144,000	1.4	42.4	6.54	2.5	52.0	2,330	2,700
SPS-1	40/28,300	0.5	38.1	2.87	2.5	44.0	250	300

Note: Above values based on starting without siphon in effect, discharge pipe flowing 2/3 full through discharge pipe invert high point, velocity head, trash rack 0.5' loss. Pump and motor eff included in HP

Model Studies

Based on the size and capacity of PS-1 and PS-2 pump station, physical modelling of its intakes and the Reservoir East Inflow-Outflow Canal (CNL-2) will be required by SFWMD during the PED phase of the

Project. The HI standard ANSI/HI 9.8 - 2009 recommends intakes of pump stations with an individual pump capacity exceeding 40,000 gpm, or non-uniform flow to the pump sump be modelled. Computational Fluid Dynamics (CFD) models may also be used to assist in the design of the pump stations intake and approach canal.

Experience has shown that modeling of pump intakes can predict issues and use of the model to simulate physical solutions to issues can result in prevention of problems in the full-size facility. Modelling relies on dimensional analysis and the laws of similitude or similarity. These laws permit the application of certain relations by which the test data can be applied to other cases. The laws of similitude make it possible to predict the performance of the prototype from tests made with a model.

Geometric similarity means the model and the prototype are identical in shape but differ only in size. The scale factor or the ratio of the linear dimensions of the prototype to the corresponding dimensions of the model is an important consideration to ensure an accurate model.

If two systems are dynamically similar, corresponding forces must be in the same ratio. Dynamic similitude is achieved when two flow systems which are geometrically similar satisfy the dimensionless equation of motion. Any deviation is termed a scale effect. The dimensionless terms that must have the same value in both flow systems include:

- Relative submergence = h_8 / r_0
- Circulation number = $G_n = G_{r0} / Q$
- Froude number $F_n = (Q / r_0 h_8) / (g h_8)^{0.5}$
- Reynolds number = $R_n = Q/v h_8$

The objective of a model study is to ensure the intake design generates favorable flow conditions in the inlet to the pump. Intake models are operated using Froude similarity since the flow process is controlled by gravity and inertial forces. In modeling an intake it is important to select a reasonably large geometric scale to minimize viscous and surface tension scale effects and reproduce the flow pattern in the vicinity of the pump. The model must be large enough to allow visual observations of the flow patterns, accurate measurements of swirl and velocity distribution and sufficient dimensional control.

Comparison of model to prototype regarding vortex formation indicates negligible scale effects for Froude scaled models with weak vortices and surface dimples. Some scale effects were detected for models in which air core vortices occurred. Compensation for these scale effects is possible by some increase in model flow above the Froude scaled value. It is important the Reynolds and Weber numbers be sufficiently high to avoid the potential of scale effects. Models at higher scale ratios yield higher Reynolds and Weber numbers at the same Froude number.

A.12.2.7 Requirements for Axial Flow Pumps

The pump equipment should be designed for intermittent service which is a normally idle piece of equipment that is capable of immediate automatic or manual start-up and continuous operation. The pump equipment including auxiliaries shall be designed and constructed for a minimum service life of 25 years excluding normal wear parts. The estimated average annual operating time for each of the PS-1 and PS-2, 375-cfs pumps, is 1,728 hours (72 days), with most of this operating time requiring continuous operation for several weeks during each wet season. This estimated operating time is derived from the

average annual volume of water that should typically be available from the C&SF system for filling the reservoir, based on the results of SFWMD's regional simulation modeling for the Recommended Plan, presented in **Annex A-2.4**. The characteristic of flow to the pumps includes storm water that may contain sand, silt, and floating or transported debris capable of passing the trash rack. Water temperature range should be in the range of 80 to 90 degrees F. Pumps will be water lubricated.

The pumps should be designed to facilitate routine and heavy maintenance. ANSI/HI 2.4-2000 provides guidance for the installation, operation, and maintenance of vertical pumps. Major parts, such as the bowl components, should be designed and manufactured to ensure accurate alignment on reassembly. For vertical pumps with FSIs. The pumps in this facility will operate through formed suction intakes (FSIs), requiring maintenance to be performed from the pump deck.

Dynamic Analysis

The pump manufacturer will be required to provide the following analysis to ensure the critical speed of the pump does not coincide with the rated operating speed.

Lateral Critical Speed

The manufacturer shall determine the lateral (dry) critical speed of the pump rotor using static deflection calculations as described in ANSI/HI 9.6.4.2.1 - 2000. A critical speed shall not occur within 25 percent above or below the rated operating speed of the pump.

Torsional Critical Speed

The manufacturer shall determine the torsional (dry) critical speed of the pump rotor using manual calculation methods as described in ANSI/HI 9.6.4.2.3 - 2000. A critical speed shall not occur within 25 percent above or below the rated operating speed of the pump.

Lateral Dynamic Analysis

A lateral dynamic analysis shall be performed for each pump on this project. Prior to manufacture of any equipment, the pump manufacturer and the engine manufacturer in accordance with the ANSI/HI 9.6.4.2.2 - 2000 shall determine the critical speeds of the equipment in the lateral directions. A natural frequency that occurs within 25 percent above or below the rated operating speed of the pump will not be accepted. The dynamic analysis model shall be constructed using a commercially available program that uses finite element analysis methods. The system shall be analyzed at the run (wet) condition considering the effect of water mass in the column and the damping effect of the highest and lowest sump water levels. The model shall incorporate the critical frequency and mass elastic diagram information provided by the gear manufacturer. The completed dynamic analysis report shall be submitted to the Engineer prior to start of fabrication.

Torsional Dynamic Analysis

A torsional analysis shall be performed for each of the A-2 Reservoir Pump Station pumps. Prior to manufacture of any equipment in accordance with ANSI/HI 9.6.4.2.4-2000, the pump manufacturer shall determine the torsional critical speed characteristics of the equipment, including the pump and driver rotational inertias, pump and driver shaft rigidities and inertias and the rigidities of all other rotating equipment in the drive train between the pump and the driver. The analysis shall be performed using a finite element analysis method commercially available with the mass elastic information provided by the

pump and gear drive manufacturers. A torsional critical speed that occurs within 25 percent above or below the rated operating speed of the pump and the driver will not be accepted. The completed dynamic analysis report shall be submitted to the Engineer prior to start of fabrication.

Pump Components

The following components are part of the design used for each pump station. Some details of construction will vary with the manufacturer, and specific details will be required from the manufacturer in the form of cross-sectional drawings identifying internal configuration. These drawings shall identify materials of construction with federal spec references (ASTM, ANSI, ASME, etc.) A protective coating will be applied to all pump components, with the exception of those parts made of stainless steel.

Base Plate

Vertical pumps of this size and capacity are provided with a steel base plate, designed to transmit the static weight of the pump and angle gear reducer and dynamic forces generated by the mechanical components to the underlying structure. Base plate includes provisions for bolting of the mechanical components and for anchoring to the concrete structure underneath. The plate shall have a concentric opening sufficient to remove the assembled pump, less the FSI. Proper design of the base plate is required to preclude harmonic vibrations due to resonance induced by the mechanical system. Base plates of this size typically have reinforcing gussets beneath the plate for enhanced strength and stiffness. It is also important that the base plate achieves uniform bearing on the underlying structure.

Drive Pedestal

A drive pedestal is generally provided between the motor or gearbox and the pump, mounted on the base plate to provide access to the shaft seal and shaft coupling, if so equipped. The pedestal is fabricated steel and designed to support the weight and dynamic loads of the motor or gear box. The floor of the pedestal serves as a sump to catch and contain seal leakage. Two or more openings are provided in the wall of the pedestal to provide access to the coupling/seal and equipped with safety guards. The upper and lower plates of the pedestal are machined flat and parallel, with a register fit to assure concentricity of the vertical components. The pedestal is provided with the pump, and the manufacturer is responsible for assuring accurate fit between pump and driver. The pedestal has fastener holes that align with mating holes in the base plate.

Discharge Column and Nozzle

The pump head assembly is connected to the baseplate by a fabricated steel column, designed to direct flow from the pump head to the discharge nozzle and to provide support for the shaft. The column diameter is sized to limit the liquid velocity and associated friction losses. The column also serves to support and align the bearing spiders that hold the bearings that guide and stabilize the shaft. The ends of the column are typically attached with flanges with a register fit to the bowl assembly and the base plate to assure alignment. The column section(s) shall have lifting lugs, properly gusseted to support the sections without deformation. The upper end of the column is a solid section with a penetration for the shaft, and associated seal or stuffing box.

The design of each pump station will utilize a "Below Deck" discharge configuration, consisting of a plain end nozzle with thrust restraint lugs. The nozzle will have a connection for an air release valve to vent the

column during startup or if air is aspirated during operation. Nozzle will be a mitered design with at least 5 segments to smooth the flow around the turn.

An inner column tube shall enclose the column shaft, providing for lubrication flow and supporting shaft sleeve bearings. The inner column shall be mechanically connected to the upper end of the pump head and to the underside of the drive pedestal. A tension nut shall be located at the upper end of the inner column to assure alignment in the column and around the shaft. The lower end of the inner column shall have a throttle bushing to limit excessive relief of the lubrication water in the column.

Formed Suction Intake (FSI)

Formed Suction Intake are installed on axial flow pumps below the pump impeller to reduce the need for the design of the sump approach channel and appurtenance to provide satisfactory flow to a pump. Relatively insensitive to approach flow direction and velocity distribution at the FSI's entrance. Net positive suction head calculations need to consider the head loss through the FSI. The FDI will be designed in accordance with the ACE standard for the Type 10 FSI (ETL No. 110-2-327). A physical model will be required for the FSIs to ensure there is adequate submergence and no vortex formation.

Pump Assembly

The pump assembly consists of three components, the inlet, the propeller bowl, and the diffuser. The components are bolted together with register fits for alignment and support the shaft over its length. The inlet is flanged to the FSI. The inlet also includes the foot bearing, supported by a spider, which supports the outboard end of the propeller shaft. The propeller bowl contains the impeller and is shaped to provide an efficient flow pattern and close running tolerance with the propeller periphery. The diffuser is fitted with multiple vanes that straighten the flow exiting the propeller, creating an axial flow pattern in the column. The vane count should not be an even multiple of the number of propeller vanes to reduce hydraulic resonance in the pump head due to vane passing frequencies. The upper pump head bearing is mounted on a spider in the diffuser, maintaining the running clearances in the pump head. The propeller is supported in the pump head by the head shaft that extends from the foot bearing to above the diffuser bearing, where it couples to the column shaft.

The pump propeller shall be of axial or mixed flow design, depending on the required head on the pump. Vanes shall be smooth in order to provide maximum efficiency and fabricated unit dynamically balanced. Propeller shall be retained on the shaft by both axial and radial keys. Propeller shall be polished, with smooth flow surfaces.

Shafting

Shafting shall be machined from Type 316L stainless steel and shall be sized to handle the full rated horsepower of the driver as well as total dead and thrust load of the rotating assembly, with a conservative safety factor. Shafting shall be machined and polished over the full length.

Shafting shall be manufactured in accordance with ASME B106.1M – Design of Transmission Shafting, for a safety factor of 5.0 based on ultimate tensile strength of the shaft material and the rated horsepower of the engine; also, 75 percent of the yield strength of the shaft material and the maximum horsepower of the engine. The shaft stiffness shall limit deflections under the most severe dynamic conditions over the allowable operating range of the pump in accordance with the performance requirements of the shaft seals and bearings. The running clearances shall be sufficient to ensure dependability of operation and

freedom of seizure under all specified operating conditions. All shafts shall be designed to operate within the allowable vibration tolerances in the preferred operating region and ensure the lateral and torsional first critical speeds occurs 25 percent above or below the rated pump speed.

Shaft Sleeves

Shaft sleeves shall be provided at the seal/stuffing box, and at each sleeve bearing to provide a renewable surface without replacing the shaft. Sleeves shall be pressed on the shaft and locked with pins or threaded dowels. Other locking means may be submitted and evaluated. The surface finish of the sleeve shall be at least 16 micro-inch RMS for seals and 32 micro-inch RMS at bearings. Surface finish requirements may be increased if required by the seal and bearing suppliers. Surface finish requirements shall be the responsibility of the pump manufacturer.

Shaft Seals

Shaft seals shall be lip-type with stainless steel lip and shall be sealed to the stationary component.

Shaft Couplings

Shaft couplings shall be rigid and keyed to the shaft ends and of the same material as the shafting. Couplings shall have a torque transmission capacity at least equal to that of the shaft. Coupling machining shall assure concentricity of adjacent shaft ends, and the finished couplings shall be factory balanced. Coupling bore and exterior surface shall be polished. Coupling spacing shall be as determined by the pump manufacturer, based on the shaft design. Coupling design shall be subject to review and approval.

Bearings

Shaft column bearings shall be water lubricated (hydrodynamic) design of a non-metallic synthetic polymer alloy Thordon SXL or approved alternate. The bearings shall be grooved and machined to marine clearances and shall be of sufficient length to keep bearing pressure within the bearing manufacturer's design limits. Lubricating water will be canal water supplied by a bearing lubricating water system external to the pump. The system flow rate shall be in accordance with the recommendations of the bearing manufacturer. The bearing design and running tolerance between bearing and shaft sleeve shall be the responsibility of the pump manufacturer. Bearing spacing and tolerance shall prevent lateral harmonic vibration and excessive runout. Bearings shall be field replaceable. The bowl suction bearing shall be a sand cap to exclude sand and grit from entering.

Stuffing Box

The pump shaft shall be sealed at the drive pedestal floor with a water-lubricated or grease-lubricated stuffing box. Access to the stuffing box shall be through openings in the drive pedestal, which shall be sized to allow ample maintenance clearance. Seal shall be provided by multiple rings of braided packing which are compressed by a follower gland at the upper box opening. A split lantern ring shall be located near the midpoint of the packing rings, with an external lubrication and relief fitting.

Materials of Construction

Materials for the pump must be resistant to abrasion as well as corrosive/brackish waters that come into contact with the operating components. Materials must be compatible with fabrication techniques used in the manufacture of the pumps. All materials used should be subject to applicable federal specifications similar to those indicated in **Table A.12-11**. Minimum material requirements are listed in the table.

Table A.12-11. Pump Material Specifications.

Component	Material Specification
Base plate	Carbon Steel—ASTM A36
Discharge column and elbow	Carbon Steel—ASTM A283 Grade C or A516 Grade 70
Drive pedestal	Carbon Steel—ASTM A36
Pump head components	Cast Iron—ASTM A48 Class 30
Suction bell or inlet casting	Cast Iron—ASTM A48 Class 30
Shafting	Stainless Steel—ASTM A276 Type 316L
Shaft couplings	Stainless Steel—ASTM A276 Type 316L
Inner column	Stainless Steel—ASTM A276 Type 316L
Shaft sleeves	Stainless Steel—ASTM A276 Type 316L
Propeller	Cast Copper Alloy—ASTM B584-C87500
Packing Gland	Stainless Steel—ASTM A743 Type 316L
Nuts, bolts, dowels, keys, fasteners	Stainless Steel—ASTM A193 Type 316L

A.12.2.8 Requirements for Electric Motor Drivers

The PS-2 375 cfs pumps and the SPS-1 50 cfs pumps will be operated by electric motors. When used for driving vertical, axial/mixed flow wet pit pumps, the electric motor will be mounted to the top of the pump column and coupled directly coupled to the impeller drive shaft.

The output power to be delivered by the motor will be based on the input power required by the pump and pump curve from shut off head to the maximum operating flow range as determined by the pump manufacturer. The motor shall not be overloaded through pump's allowable operating region. The motor's output power shall be determined by the manufacturer in coordination with the pump manufacturer.

The motor manufacturer in coordination with the pump manufacturer, shall ensure the motor proposed has adequate accelerating torque under full load start-up conditions (additional torque required above normal operating torque) for the pump to attain the rated speed in a reasonable amount of time.

Project Site Conditions

- Maximum air temperature: 105°F
- Minimum air temperature: 35°F
- Maximum raw water temperature: 90°F
- Minimum raw water temperature: 60°F
- Elevation: approximately 40.0 ft NAVD88
- Relative humidity: 80 percent

Rotation

The rotation of the motor should be the SAE standard rotation with the motor speed reducer to match the pump rotation. It is intended that the motor deliver power in one direction only and an anti-reverse rotation device shall be provided to prevent reverse rotation by the backflow of water through the pump at shut down.

Motor Mounting

Pump manufacturers should provide pump and motor as a single unit. The pump column and base plate will support the motor. It is important to foundation requirements.

Coupling Assembly

Pump manufacturers will provide the coupling between the motor and the pump.

Component Specifications

The following list of components is a generalized list and should not be considered a complete and comprehensive description of all the component pieces of a finished speed reducer. It should also be recognized that reducer designs vary from manufacturer to manufacturer and the component descriptions may not be representative of a particular design.

Shafts

Each shaft shall be heat treated stainless steel. Welded shafts are not acceptable. Input shaft size and configuration shall be compatible with the driver. The pump head shaft shall accommodate the hollow shaft design of the reducer's output shaft to permit vertical adjustment. Sufficient thread length shall be provided to the top of the pump shaft to permit 1-inch adjustment, either up or down of the pump shaft. The adjusting nut shall be designed to support the total axial load and thrust of the pump and be locked in position to prevent movement.

Seals

The down output shaft shall have a drywell design seal. The input shaft shall have a lip seal to prevent leakage of the oil and exclude dirt. Lip seals shall utilize hardened steel wear sleeves to preclude shaft repair or replacement.

Rolling Bearings

Rolling bearing elements are located on the shaft using shoulders, collars, or other positive locating devices and shall be retained on the shaft with an interference fit and fitted into the housing with a diametral clearance, both in accordance with the recommendations of ISO 286 (ANSI/ABMA 7 - 1995). The rolling element bearing life shall have a basic rating of L10 per ISO 281 (ANSI/ABMA 11 - 1990) of at least 100,000 hours with continuous operation at the rated condition, and at least 16,000 hours at maximum radial and axial loads and rated speed.

Thrust Bearings

The entire weight of the rotating element of the pump and hydraulic thrust, (up-thrust and down- thrust), imposed by the propeller and any radial loads created by the reduction gear shall be carried by the thrust bearing located in the reducer. The thrust bearing shall be sized for continuous operation under all specified conditions and shall provide full load capabilities if the pump's normal direction is reversed. The thrust bearing shall be a steep angle tapered bearing type. Misalignment of the outer and inner bearing rings shall be limited to 0.001 radian for cylindrical and tapered-roller bearings and 0.0087 radian for spherical ball bearings. Bearings shall be mounted directly on the shaft, bearing carriers are not acceptable.

Radial Loads

Radial load can be addressed by the thrust bearing(s) or separate rolling element bearings can be provided.

Housing

The reducer housing shall be cast or fabricated steel, stress relieved prior to machining, and reinforced to carry all applied loads and maintain gear alignment. The unit may be made in several sections, split as required, for service and assembly and heavily ribbed to insure strength and rigidity. The housing shall be so constructed as to provide stability that maintains precise alignment of the gears and shafts. All joints shall be finished machined and oil tight.

Inspection Openings

Inspection openings with cover plates shall be provided over each set of gears. All inspection, access, service and other type openings shall be provided with suitable metal covers, vented, screened and easily removable as necessary to insure continuous protection against the entrance of insects, rodents and the elements throughout the expected life of the equipment.

Lifting Lugs

The unit shall be provided with eye bolts or lifting lugs for installation and removal.

Instrumentation

The instrumentation supplied with the reducer shall be a complete working package that has been coordinated with the pump and driver supplied. The reducer shall have the following devices:

- **High Oil Temperature:** An oil temperature sensor shall be provided to monitor the oil temperature in the reducer sump. The alarm and shut down shall be part of the system's control and monitoring system. Lower settings may be used if recommended by reducer manufacturer. Typically the alarm is set at 180°F, the shut down at 200°F.
- **Oil Pressure:** Provide a gauge after the oil pump to monitor oil pressure. The gauge shall be oil or glycerin filled and shall have an isolation valve.
- **Temperature Gauges:** Provide thermometers in the sump, in the oil line after the heat exchanger, and the backstop.
- **Oil Level Sight Gauge:** Provide an oil level sight gauge to monitor oil levels in the sump of the reducer.
- **Vibration Switch:** Vibration switch with the alarm and shut down shall be provided as part of the system's control and monitoring system. The manufacturer shall be responsible for the vibration switches proper settings to accommodate initial and running vibrations to avoid nuisance tripping of the switch. A time delay shall be incorporated into the control system if required. Set alarm at 0.5 inch per second or at baseline level recommended by the reducer manufacturer.

A.12.2.9 Requirements for Single-wall Piping

Single-wall piping is required to meet the standards set forth in ANSI/ASME B36.10. Pipe shall conform to ASTM A53 Grade B, Schedule 40, seamless or electric resistance welded. No pipe or fittings in the piping

systems should be galvanized. Fittings for screwed pipe are typically specified as 3,000-pound forged steel conforming to ANSI/ASME B16.11. Flanges shall be standard weld-neck type, 150-pound forged steel, ASTM A181, and conforming to ANSI/ASME B16.5. Flange facings shall correspond to the equipment to which the piping is joined, and, unless otherwise required shall be standard 1/16-inch raised face flanges. Machine bolts are heavy hexagonal alloy steel conforming to ASTM A307, Grade B. Nuts shall be heavy hexagon alloy steel conforming to ASTM A563, Grade A. All flexible oil lines, such as connections to the engines, should be specified as reinforced nitrile hydraulic hose with stainless steel braided sheathing.

A.12.2.10 Requirements for Mechanically Cleaned Trash Racks

Debris entering the pump feed channels from the canal is removed by mechanical trash racks in front of each pump. Openings are set at three inches, which will remove all material that would be damaging to the pumps. Material blocked by the bars is conveyed to the top of the rack and dropped in containers on the pump station deck. Containers are emptied by trucks as needed, from an access drive on the pump deck. The amount of debris collected is a function of the flow in the RIOC Canal and recent weather conditions. Screens are custom, heavy-duty units designed for service in stormwater applications.

Description of Equipment

The screening system consists of heavy-duty bars with a 3-inch clear spacing set on an 60° angle from horizontal. The bars are cleaned by a front clean-front return collection mechanism. Debris that is retained on the bars is collected by rakes attached to two continuous heavy-duty chains and deposited in containers on the pump deck. The rakes are spaced on 63-inch centers to prevent buildup on the bars when the mechanism is in operation. The chains are driven by the headshaft at the top of the sidebeams. The headshaft is driven by a gearmotor through a chain and sprocket arrangement. The chains are guided by a stationary track with a low-friction, replaceable cover to the bottom of the screen, where they return, riding on the bars and then a deadplate. The debris discharges from a chute that mounts at the top of the deadplate. The entire mechanism and support structure are fabricated of Type 316 stainless steel. Design of the screens does not require any maintenance activities be performed in the approach channel.

Controls

Screen controls will be enclosed in a NEMA 4X stainless steel control panel located adjacent to the individual screens. Control logic will be by a PLC, which will handle all functions of the screens and protective systems. Screens are operated through a Hand-Off-Automatic selector, such that Hand mode runs continuously, Off is inactive, and Automatic operates based on differential head on the screen. In the Automatic mode, an adjustable timer operates the screen for an adjustable, preset time regardless of differential head. The control panels will be equipped with self-contained air conditioning units to protect the electronics from high ambient heat.

A.12.2.11 Requirements for Discharge Piping and Appurtenances

Pipe

Discharge piping for the pumps shall be spiral-welded steel conforming to AWWA C200 and AWWA M11, with the exception of post fabrication hydrostatic testing will not be required. Minimum pipe wall thickness shall be as shown in **Table A.12-12**.

Table A.12-12. Pipe Wall Thickness.

Pipe Diameter (inches)	Minimum Pipe Wall Thickness (Inches)
144	0.75
132	0.75
96	0.75
84	0.75
78	0.625
60	0.625
36	0.5

Materials:

Piping shall be fabricated from one of the following materials:

- Sheet or coil conforming to ASTM A570, Grade 30, 33, 36 or 40
- Plate in coil form conforming to ASTM A36, A283 Grades C or D, or ASTM A572 Grade 42
- Coil conforming to ASTM A139, Grades A or B

Pipe Joints:

All joints shall conform to AWWA C200 and AWWA C207 with a Class B pressure rating and be drilled to ANSI B16.1 Class 25.

Fittings and Special Connections

Elbows shall be fabricated from tested pipe to conform to AWWA C208 and shall be reinforced in accordance with applicable provisions of AWWA M11. Openings for air vent connections shall be provided with flanged outlets and shall be flanged in accordance with ANSI/ASME B16.5 standard 125-pound flange.

Harnessed Coupling

A flexible mechanical coupling, Dresser style or equal, shall be provided to connect the pump discharge elbow to the discharge piping. All components of the coupling shall be stainless steel. The connecting ends of the discharge pipe shall be fabricated in accordance with the requirements of the coupling provided. Adjustable thrust rods shall be provided to transfer thrust loads to the discharge piping or wall thimble. All bolts, rods, nuts, and associated hardware shall conform to ASTM F593 Type 316 stainless steel.

Wall Thimble

A wall thimble shall be provided for connection to the pump discharge elbow and the discharge piping or flap valve. The thimble shall have a seal ring centered in wall when embedded and shall have flanged ends to mate to the discharge piping.

Gaskets and Bolting Materials

Gaskets for flanged joints shall conform to ANSI B16.21, 1/8-inch-thick full-face synthetic rubber. Full-face gaskets for all pump and equipment connections shall be provided. Bolts for flanged joints shall conform to ASTM F593 Type 316 stainless steel. Nut and bolt heads shall be hexagonal.

A.12.2.12 Backflow and Dewatering Gates and Operators

The hydraulic design of the PS-2 and SPS-1 pump stations provides for a vacuum breaker at the peak elevation of the discharge pipe at the top of the dam. This prevents backflow from the reservoir to the RIOC Canal. In order to allow maintenance on the mechanical screens, provision for needle beams will be installed between the canal and the screens. A crane will be provided for installing and removing the beams, and a storage rack provided. No motorized gates are required.

A.12.2.13 Station Emergency Power

Pump stations PS-1 and PS-2 will require backup generators to power controls, HVAC, water system, communications, fire alarm and security. Two generators will be installed to provide redundancy during outages or storm events.

Pump station SPS-1 will require backup generators to power its pumps, controls, HVAC, water system, communications, fire alarm and security. Two generators will be installed to provide redundancy during outages or storm events.

A.12.2.14 Stage Monitors

Intake canal conditions for each pump station will be monitored with level transmitters installed in stilling wells. A level measurement will be taken in each pump approach channel with a level sensor in a stilling well to prevent screen blinding from causing operating levels from falling below manufacturer's minimum recommendation. Level transducers will communicate via a 4-20 ma DC signal, powered by a 120-volt to 24-volt power supply. Level information will be transmitted to the pump station and available for remote monitoring.

A.12.3 Gated Structures

See **Section A.6** for additional information about the gated structures that are part of the project.

A.12.3.1 Roller Gates

Roller gates will be used to control and regulate flows in the LOCAR system. Gate components consist of a Gate disc, seals, rollers, guide rails, and sill plate.

A.12.3.2 Gate Hoist

Gate hoists will use a drum and cable system. This system will use an electric motor coupled to a worm gear reducer to drive cable drums that will operate the cables attached to the gates. Position indicators, and slack cable limit switches will control range of motion for the gate. Operation of the gates will be subject to automatic control based on headwater/tailwater elevations. Gate will operate at a speed of 6 inches per minute.

A.12.3.3 Emergency Power

The gated structures will require backup generators to monitor water levels and operate gates. For each gated structure, its back-up generator will be housed in a precast building and powered by propane stored in an on-site tank.

A.12.3.4 Stage Monitors

Water levels upstream and downstream of each gated structure will be monitored with level transmitters installed in stilling wells.

A.13 Electrical Design

A.13.1 Design Criteria

A.13.1.1 Pump Station PS-1 and Gate Structure S-84+ Utility Power

Florida Power & Light (FPL) overhead, three-phase, 13.2-kilovolt (kV) power lines run alongside State Road 70, approximately 2 miles (mi) north of proposed LOCAR pump station PS-1 and gate structure S-84+. Preliminary contact with FPL was made to inform them of proposed pump station PS-1 and gate structure S-84+, and the anticipated power demands. No additional information was received from FPL at this time concerning what overhead lines would be extended to serve pump station PS-1 and gate structure S-84+. A conceptual site plan which shows how electrical service may be extended to PS-1 and S-84+ is provided in **Annex E-1**. During the PED phase, the design team will coordinate with FPL to further develop the FPL design of their system to provide permanent electrical service to pump station PS-1 and gate structure S-84+.

A.13.1.2 Pump Stations PS-2 and SPS-1, and Structures CU-1A and CU-1B Utility Power

FPL overhead, three-phase, 13.2-kV power lines exist alongside of State Road 70, approximately 0.75 mi southeast of proposed LOCAR pump stations PS-2 and SPS-1, gated structure CU-1A, and adjustable weir structure CU-1B. Preliminary contact with FPL was made to inform them of proposed pump stations PS-2 and SPS-1 and structures CU-1A and CU-1B, and the anticipated power demands. No additional information was received from FPL at this time concerning what overhead lines would be extended to serve the new pump stations PS-2 and SPS-1 and structures CU-1A and CU-1B. A conceptual site plan which shows how electrical service may be extended to PS-2, SPS-1, CU-1A, and CU-1B is provided in **Annex E-1**. During the PED phase, the design team will coordinate with FPL to further develop the FPL design of their system to provide permanent electrical service to pump stations PS-2 and SPS-1, gated structure CU-1A, and adjustable weir structure CU-1B.

A.13.1.3 Gate Structure DDS-1 Utility Power

Preliminary contact with FPL was made to inform them of the proposed gate structure DDS-1, and the anticipated power demands. No additional information was received from FPL at this time concerning what overhead lines would be extended to serve the new gate structure DDS-1. A conceptual site plan which shows how electrical service may be extended to DDS-1 is provided in **Annex E-1**. During the PED phase, the design team will coordinate with FPL to further develop the FPL design of their system to provide permanent electrical service to gate structure DDS-1.

A.13.1.4 Gate Structure CU-2 Utility Power

Glades Electric Cooperative (GEC) overhead, single-phase, 13.2-kV power lines are existing at the southwest corner of LOCAR at existing gate structures S-83 and S-83X. Preliminary contact with GEC was made to inform them of the proposed gate structure CU-2, and the anticipated power demands. No additional information was received from GEC at this time concerning what overhead lines would be extended to serve the new gate structure CU-2. A conceptual site plan which shows how electrical service may be extended to CU-2 is provided in **Annex E-1**. During the PED phase, the design team will coordinate with GEC to further the GEC design of their system to provide permanent electrical service to gate structure CU-2.

A.13.1.5 Pump Stations PS-1, PS-2, and SPS-1 Equipment Voltage

The LOCAR pump stations PS-1 and PS-2 voltage will be 4,160-volt, three-phase, and 60-hertz. The LOCAR pump station SPS-1 voltage will be 480-volt, three-phase, 60-hertz. In general, station equipment voltages will be specified to operate at the following voltages:

Motors rated 500 Horsepower (Hp) and larger	4,160 volts, three phase
Motors rated 1 Hp to 450 Hp	480 volts, three phase
Motors less than 1 Hp	120 volts, one phase
Lighting	120 volts, one phase
Convenience receptacles	120 volts, one phase

A.13.1.6 Pump Station PS-1 Power Distribution

A preliminary, one-line diagram (**Figure A.13-1**) for LOCAR pump station PS-1 is included on the following page. The distribution system will be serviced by the FPL at 13.2 kV, three phase, 60 hertz with primary metering. The FPL primary shall be connected to a district-owned stepdown transformer to provide 4,160-volt, three-phase, 60-hertz power to the pump station. The load side of the stepdown transformer shall be connected to the pump station main breaker in the medium-voltage Motor Control Center (MCC) that will have the motor starters for the four 375 CFS electric motor driven inflow pumps and a 4,160-volt, three-phase, 60-hertz breaker to feed a stepdown transformer to provide 480-volt, three-phase, 60-hertz power to the pump station. The load side of the 4,160/480-volt stepdown transformer shall be connected to a low-voltage main breaker that is in the station switchgear. The station switchgear shall feed the auxiliary support systems and house loads. The station switchgear shall have a breaker that is connected to an automatic transfer switch (ATS) that will be connected to a propane emergency generator. The load side of the automatic transfer switch will be connected to panels that provide power to pump station house loads. House loads shall include lighting; heating, ventilation, and air conditioning (HVAC); security and access control; programmable logic supervisory control and data acquisition (PLC SCADA) and communication; and potable water systems.

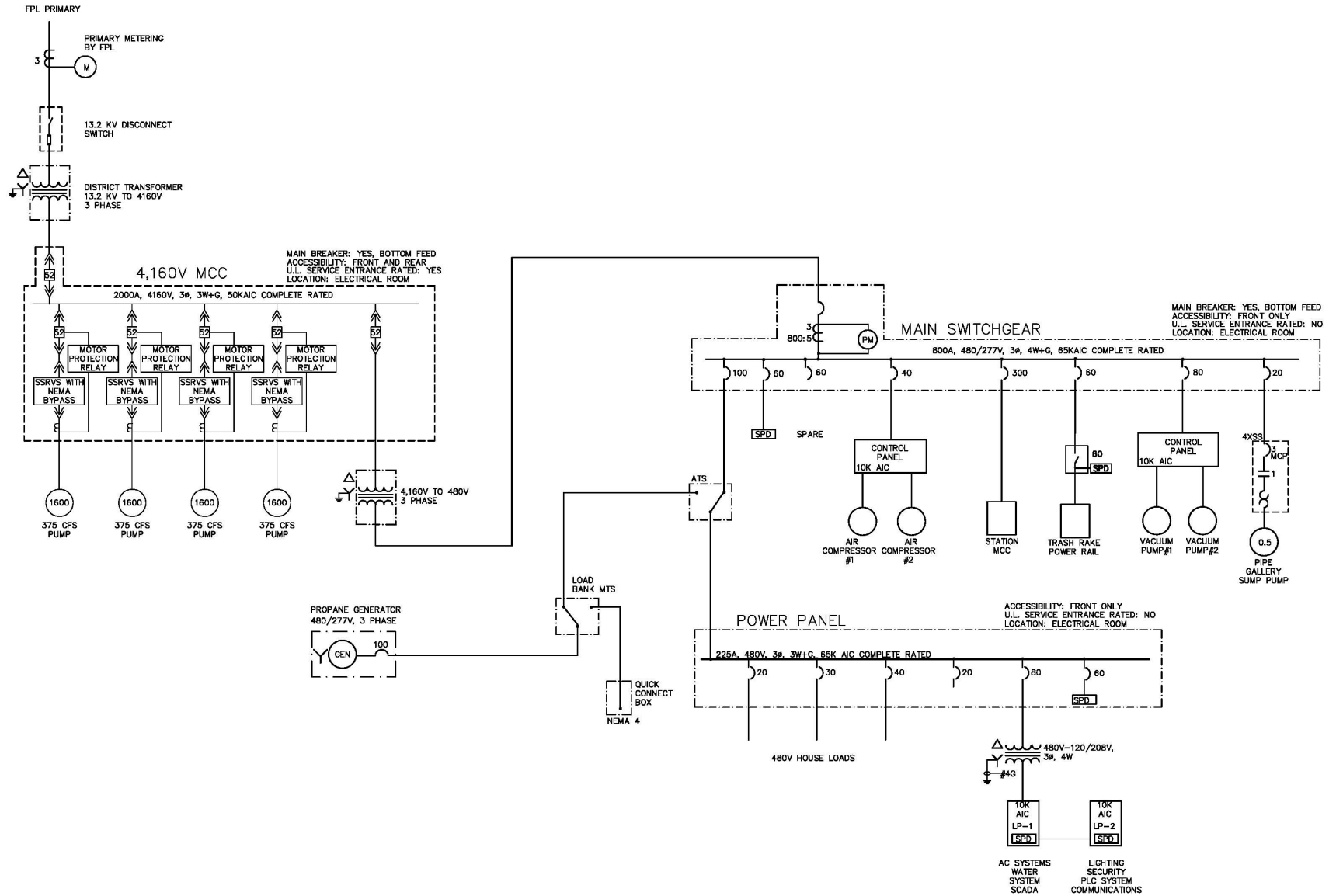

Figure A.13-1. Preliminary Pump Station PS-1 one-line diagram.

A.13.1.7 Pump Station PS-1 Switchgear

A switchgear consisting of circuit breakers will be provided to distribute 480 volts of power to various loads, including but not limited to the following equipment:

- Two vacuum system pumps
- Two air compressors
- Motor-control centers for miscellaneous loads
- Crane and hoist

The motor-control centers for miscellaneous loads will supply power to individual pumps that are not part of a vendor-supplied package and other loads as indicated below. The list of equipment is tentative and subject to change during final design.

- Building supply fans
- Building exhaust fans
- Two freshwater pumps
- Two water-lubrication pumps
- Two potable water pumps
- Two traveling trash rakes
- Two rotating strainers
- Two lighting panels (120/208-volt, three-phase)
- Motor-operated valves
- Water heater
- Instrument air compressor
- HVAC power panel (120/240-volt, single-phase)
- Fire alarm and security system power panel (120/240-volt, single-phase)
- Drainage pump bay-drawdown pump receptacle
- Other loads as required

A.13.1.8 Pump Station PS-1 Standby Generator Power

In addition to normal utility power, LOCAR pump station PS-1 will have a propane engine powered generator and automatic transfer switch to power the station house loads. Fuel storage requirements will be based on generator operation for a minimum of 7 days. Upon failure of the utility power, a transfer switch will start the generator and automatically transfer power supply to the generator. A manual generator start will be provided to exercise the unit.

A.13.1.9 Pump Stations PS-2 and SPS-1 Power Distribution

A preliminary, one-line diagram (**Figure A.13-2**) for LOCAR pump stations PS-2 and SPS-1 is included on the following page. The distribution system will be serviced by the FPL at 13.2 kV, three phase, 60 hertz with primary metering. The FPL primary shall be connected to a district-owned stepdown transformer to

provide 4,160-volt, three-phase, 60-hertz power to the pump stations. The load side of the stepdown transformer shall be connected to the pump station main breaker in the medium voltage Motor Control Center 1 (MCC-1) that will have the motor starters for the four 375 CFS electric motor driven inflow pumps for pump station PS-2 and one 4,160-volt, three-phase, 60-hertz breaker to feed a stepdown transformer to provide 480-volt, three-phase, 60-hertz power to pump stations PS-2 and SPS-1. The load side of the 4,160/480-volt stepdown transformer shall be connected to a low-voltage main breaker that will be connected to a 480-volt automatic transfer switch. The load side of the 480-volt automatic transfer switch will be connected to the low-voltage Motor Control Center 2 (MCC-2). MCC-2 will have the motor starters for the three 50 CFS electric motor driven seepage pumps for pump station SPS-1 and a breaker to feed the station switchgear. The 480-volt automatic transfer switch is also connected to a 480-volt, diesel-powered emergency generator sized to provide power for two of the three electric motor driven seepage pumps for pump station SPS-1, as one of the pumps is an auxiliary pump, in the event that one or both primary pumps are not operational. The 480-volt, diesel-powered emergency generator is also sized to provide power for the auxiliary support systems and house loads that are connected to the station switchgear. The station switchgear shall have a breaker that is connected to a smaller, 480-volt automatic transfer switch that will be connected to a smaller diesel emergency generator. The load side of the smaller, 480-volt automatic transfer switch will be connected to panels that provide power to pump station house loads. House loads shall include lighting, HVAC, security and access control, PLC SCADA and communication, and potable water systems.

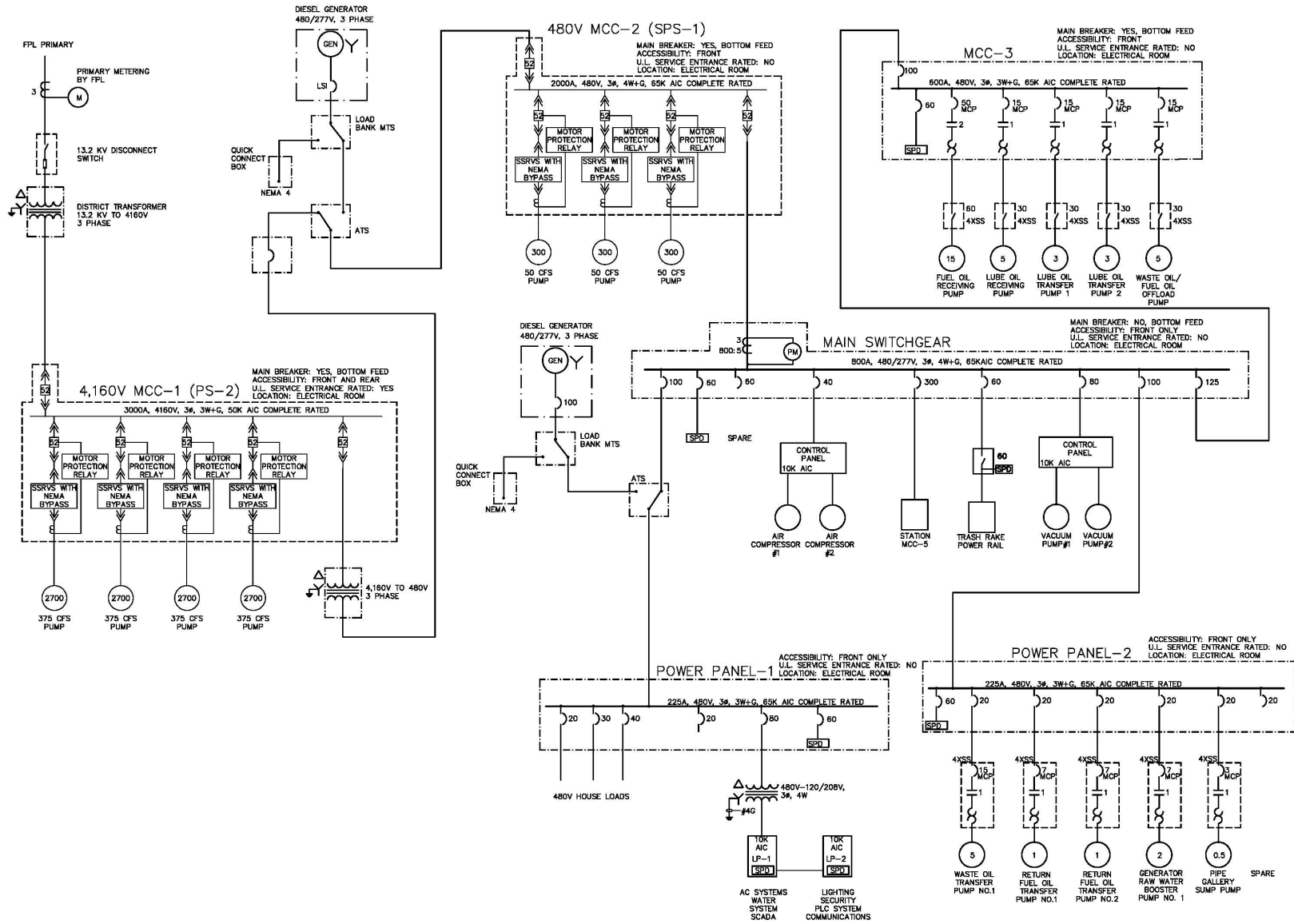

Figure A.13-2. Preliminary Pump Stations PS-2 and SPS-1 one-line diagram.

A.13.1.10 Pump Stations PS-2 and SPS-1 Switchgear

A switchgear consisting of circuit breakers will be provided to distribute 480 volts of power to various loads, including but not limited to the following equipment:

- Two vacuum system pumps
- Two air compressors
- Motor control centers for miscellaneous loads
- Crane and hoist

The motor control centers for miscellaneous loads will supply power to individual pumps that are not part of a vendor supplied package and other loads as indicated below. The list of equipment is tentative and subject to change during final design.

- | | |
|-------------------------------|---|
| • Building supply fans | • Two rotating strainers |
| • Building exhaust fans | • Two lighting panels (120/208-volt, three-phase) |
| • Two waste fuel oil pumps | • Motor-operated valves |
| • Fuel oil receiving pump | • Water heater |
| • Two lube-oil supply pumps | • Instrument air compressor |
| • Lube oil receiving pump | • HVAC power panel (120/240-volt, single-phase) |
| • Two cooling water pumps | • Fire alarm and security system power panel (120/240-volt, single-phase) |
| • Two freshwater pumps | • Drainage pump bay-drawdown pump receptacle |
| • Two water-lubrication pumps | • Cooling water pump receptacle |
| • Two potable-water pumps | • Other loads as required |
| • Two lube-oil pumps. | |
| • Two waste lube oil pumps | |
| • Generator block heaters | |
| • Two traveling trash rakes | |

A.13.1.11 Pump Stations PS-2 and SPS-1 Standby Generator Power

In addition to normal utility power, LOCAR pump stations PS-2 and SPS-1 will have diesel engine powered generators. The main generator will be sized to operate electric motor driven seepage pumps for SPS-1, auxiliary support systems, and house loads should the normal utility power fail. Fuel storage requirements will be based on the main generator operation for a minimum of 7 days. In addition to the main larger diesel engine powered generator, a second smaller diesel engine powered generator will be available to power the station house loads during a utility power failure and no seepage pumping being required for SPS-1. The second smaller diesel generator will be sized to power the station house loads only.

Upon failure of the utility power, the main transfer switch will start the main generator only and automatically transfer power supply to the main generator. When the main generator is disabled, the smaller transfer switch will start the smaller generator and automatically transfer power supply to the smaller generator. A manual generator start will be provided to exercise each unit.

A.13.1.12 Pump Stations Building Systems

Motor

Motors below 150 Hp will be totally enclosed, fan-cooled, and of premium efficiency. Motors 200 Hp and above shall be Weather Protected Type 1 (WPI) enclosures. All outdoor motors will have integral space heaters. Indoor motors 5 Hp and larger will have integral space heaters.

Monitors

The 4,160- and 480-volt MCCs, and 480-volt switchgear will each have a power monitor that will monitor line and phase voltages, phase currents, kilowatts (kW), kilovolt-ampere reactive (kVAR), power factors, and kilovolt-amperes (KVA).

Lighting and Receptacles

Lighting panel boards will be rated for 120/208 volts, three phase. Bus bars will be copper. Circuit breakers will be thermal magnetic bolt-on type.

High bay areas of the pump stations and the pipe gallery area will be provided with light emitting diode (LED) light fixtures. The control room, break room, and offices will also have LED light fixtures. Outdoor light fixtures will be wall-mounted and controlled by a photoelectric switch. The diesel tank storage area lighting will be pole mounted LED light fixtures. Lighting levels will be in accordance with the Corps EM 1110-2-3105, Chapter 21 standard.

Major paths of exit will have LED-type exit signs on a dedicated circuit. Emergency lighting will also be provided.

Switches used for lighting will be rated 20 amperes, 120 volts. Duplex receptacles will be rated 20 amperes, 120 volts. Ground fault circuit interrupter (GFCI) type receptacles will be used outdoors and in the restrooms. Office receptacles will have stainless steel plates. Outdoor receptacles will have "in-use" weatherproof covers.

Conduits and Wiring

Conduits above grade will be Galvanized Rigid Steel. Conduits below grade will be Polyvinyl Chloride (PVC) Schedule 40 pipe. Underground conduits, in general, will be encased in concrete.

Liquid-tight flexible metal conduit will be used at all motors, transformers, instruments, and any other equipment that can vibrate or move. Galvanized rigid steel conduits will be terminated at equipment and boxes with insulated plastic bushings. The cable tray will be reviewed for use in the pump stations during final design.

Wire for 480-volt power applications will be thermoplastic, high-heat resistant, nylon coated (THHN)/thermoplastic heat and water-resistant nylon-coated (THWN) insulation with stranded copper conductors. The minimum size wire will be 12 gauge.

Wire for control and alarm circuits will be multi-conductor type THHN/THWN insulation, with stranded copper conductors, and a nylon jacket suitable for installation in either a tray or conduit. The minimum size wire will be 14 gauge.

Wire for milliamp (mA)/millivolt (mV) circuits will be single pair shielded instrument cable, type Thermoplastic Fixture Wire Nylon Jacketed (TFN) insulation, with stranded copper conductors, and a nylon jacket suitable for installation in either a tray or conduit. The minimum size wire will be 16 gauge.

Lightning Protection

The building will have air terminals on the roof interconnected with copper conductors.

Grounding

A ground ring will be installed around the pump stations PS-1, PS-2, and SPS-1 consisting of 4/0 copper cable and ground rods to establish a resistance of 5 ohms or less. The building's steel columns, steel rebar in the footing, water piping, lightning protection system, motors, panels, transformers, etc., will be connected to the ground ring in accordance with the National Electric Code.

Fire Alarm System

A zoned, supervised fire detection and alarm system will be installed. Ionization type smoke detectors will be used in the pump room and the generator room. To protect against false alarms, the detectors in these rooms will be cross-zoned, so that two detectors must be initiated before an alarm is sounded.

Closed Circuit Television System

A closed-circuit television (CCTV) system, per standards for major pump stations, will be installed in pump stations PS-1, PS-2, and SPS-1.

Electrical Design for Auxiliary Support Systems

In the electrical design of pump station SPS-1, the feeder breakers for the MCCs for the auxiliary-support systems are located in the main switchgear to allow for the main emergency generator to operate all pump station auxiliary loads.

Materials of Construction

The switchgear manufacturer should have a distributor and authorized service representative within the State of Florida. Acceptable manufacturers will be Square D, Siemens, Cutler Hammer, Allen-Bradley, General Electric, or approved equal.

Distribution panel boards (480-volt) and lighting fixtures will be industrial grade.

Generators will be Cummins Onan, Caterpillar, or approved equal. Automatic transfer switches will be Cummins Onan, Asco, Zenith, or approved equal.

Galvanized rigid steel conduit will be Allied, Triangle, or approved equal. PVC conduit will be Carlon, Certain-Teed, or approved equal. Liquid-tight conduit will be Electri-Flex, Carol Cable, Anamet, or approved equal.

Wire and cable will be Okonite, Alpha, or approved equal.

A.13.1.13 Valve Operators and Controls

The valve operators will be similar to Limatorque operators, which have an integral reversing starter; limit switches; control power transformer; open, stop, and close pushbuttons; and local-remote selector switch. The operators will require 480-volt, three-phase power from the MCCs. A locally mounted safety disconnect switch will be provided near each valve operator.

A.13.2 Pump Station Engineering Guidelines

The SFWMD has in place a standard titled "Pump Station Engineering Guidelines" dated January 2021. That document was used in preparing the basis of design section concerning the electrical design of LOCAR pump stations PS-1, PS-2, and SPS-1.

A.13.3 Gate/Adjustable Weir Operators and Controls

A.13.3.1 Electrical Design for CU-1A, CU-1B, CU-2, and DDS-1

The gate operators for CU-1A, CU-2 and DDS-1, and the adjustable weir operator for CU-1B will be similar to Limitorque operators with the drive motor and limit switches; but without the integral reversing starter; control power transformer; open, stop, and close pushbuttons; and local-remote selector switch. The operator voltage and number of phases will be determined based on the available power at each culvert site. A locally mounted safety disconnect switch and pushbutton station will be provided near each gate and adjustable weir operator.

A.13.3.2 Electrical Design for S-84+

The gate operator will be a cable drum hoist system with the drive motor and limit switches at the gate structure. The reversing starter; control power transformer; open, stop, and close main pushbuttons; and local-remote selector switch will be in the local control building. The operator voltage and number of phases will be determined based on the available power at the gated spillway site. A locally mounted safety disconnect switch and pushbutton station will be provided near each gate operator.

A.14 Instrumentation and Controls

A.14.1 Design Criteria

This section defines the instrumentation and controls design criteria for the water control facilities (CU-1A, CU-1B, CU-2, DDS-1, and S-84+), LOCAR pump stations (PS-1, PS-2, and SPS-1), and telemetry systems. All systems will be designed in accordance with SFWMD standards. All systems and facilities, as general practice, will be monitored and controlled from a local control system in the pump stations. The local control system will be PLC-based. Monitoring and control will be available from the Remote Terminal Unit (RTU) of the SFWMD SCADA facilities. The existing telemetry system centralized at the SFWMD headquarters will be extended to include the new facilities. Instrumentation and control features will include the following features:

- The master control PLC will be an Allen-Bradley ControlLogix 1756 PLC system. Packaged systems in the pump stations will be provided with stand-alone Allen-Bradley ControlLogix PLCs communicating over Ethernet-IP.
- Monitoring and control of remote sites, including gated spillways, gated culverts, and monitoring stations will be over RF radios. Equipment will be controlled by the site's RTU.
- Pumps will have control from the SFWMD Control Center, through the RTU. Gated structures will also have control through the Control Center.
- Analog control signals will be 24 VDC, 4-20 mA. Discrete signals will be 24-volt, direct current (VDC). Interposing relays shall be used where necessary to provide isolation and conversion to 24 VDC. Discrete output signals will interface field devices through interposing relays. Surge suppression shall be provided for all instrumentation. The SFWMD design details will be followed.

A.14.2 LOCAR and Canals

The level of LOCAR and all canals associated with the LOCAR Pump Stations (PS-1, PS-2, and SPS-1) will be monitored through Motorola ACE RTUs. The signal will be transmitted to the SCADA system for display.

The SFWMD standard for level monitoring is the Waterlog absolute encoder, located in a stilling well. For variable applications exceeding 20 ft, the Endress+Hauser Model Waterpilot FMX21 pressure transmitter provides increased range. Stilling wells shall be installed in accordance with the SFWMD design details. Water levels in the embankment will be monitored with piezometers. Water quality monitoring will be provided as outlined in the SFWMD design details.

A.14.3 Water Control Facilities

Monitoring and control of the gated structures (CU-1A, CU-2, DDS-1, and S-84+) and adjustable weir structure CU-1B will be through the Motorola ACE RTUs. Control of the gates will be either manual or from the control system, based on water levels in the LOCAR East Cell, the LOCAR West Cell, and the C-41A Canal.

A.14.4 LOCAR Pump Stations

Pump station control and monitoring can vary from simple, manual operation of an agricultural style station to more complicated automatic or remote operation of a typical SFWMD station. There are also

varying degrees of complications for the remote operation of a station. Electric motor drivers have far fewer auxiliary systems than a diesel engine driven pump station; and therefore, have much simpler control and monitoring systems. Electric-driven pump stations are also typically not used for flood control applications due to the possibility of power outages during a storm event. Therefore, pump system reliability requirements for flood control stations do not apply to electric motor driven stations. SFWMD pump station auxiliary systems and driver start/stop are controlled by a PLC. The receiving and sending of control and monitoring data are via an RTU.

A.14.4.1 Operation

In the more recently constructed SFWMD pump stations, there are typically four modes of operation: local/manual (based on hardwired controls), local/auto (based on PLC controls from the local control panel within the facility), remote/manual (based on PLC controls from the other human machine interfaces [HMIs] within the facility), and remote/auto (same as local/auto, but based on station/central key switch permissive in main station control panel—set to central).

The Station Control Center (SCC) PLC shall be networked through a converter to the Motorola ACE RTU for communication to the SFWMD's operational center. Instrumentation signals for station monitors such as stage data and electrical service power phase monitoring shall be connected directly to the Motorola ACE RTU unit.

A.14.4.2 Programmable Logic Controller

The microprocessor-based controller shall be an Allen-Bradley model or SFWMD approved equal for machine-level control applications requiring limited input/output (I/O) quantities and limited communications capabilities. The PLC shall be mounted in the SCC and shall provide control and monitoring of the electric pumps and auxiliary systems. The SCC PLC will be in a network linked to other PLCs, and from the SCC PLC a RS232 connection shall be established with the Motorola ACE RTU via a Modbus over serial converter.

A.14.4.3 Display Panel

An Allen-Bradley HMI display panel will be provided for each PLC. The SCC shall be located on the pump room floor with an HMI display mounted in the SCC door. A couple HMI displays will also be in the pump station control room for control and monitoring capabilities for all station systems.

A.14.4.4 Interface Module (Modbus/RS232)

A ProSoft inRAX module MVI56E-MCM shall be provided for conversion of network digital output to the serial communication signal that is required by the Motorola ACE RTU.

A.14.4.5 Surge Suppressor

A surge suppressor will be provided that will protect the I/O modules of the PLC from lightning-induced surges, electrical fast transients, and electromagnetic interference (EMI) or radiofrequency interference (RFI) noise. The surge suppressor shall meet or exceed the highest-class severity level of International Electrical Commission (IEC) 1000-4-4 and 1000-4-5. The suppressor shall be UL-497B-listed. The surge protector will be Circuit Components, Inc.'s "Surge Control SAB Series" or an SFWMD-approved equal.

A.14.4.6 Vibration Switch

Each reduction gear shall be provided with a vibration-control switch to protect the equipment from damaging shock or vibration. Each switch shall be a 24-VDC powered electro-mechanical device, with two single pole, double throw (SPDT) snap-acting switches rated at 2 amps (A) up to 30 VDC and mounted in a National Electrical Manufacturers Association (NEMA) four enclosure. Each switch shall have a remote reset to allow reset of the tripped unit from a remote location, an adjustable time delay to override trip operation for a preset length of time (to prevent trips during transient pump cavitation events, for instance), and a fine adjustment to precisely select the degree of sensitivity.

A.14.4.7 Temperature Monitors

The temperature probes provided shall be resistance temperature detectors (RTDs) and shall comply with ANSI 34. RTDs shall be 100-ohm, 3-wire platinum in a Type 304 stainless steel sheath with watertight connection head.

A.14.4.8 Liquid Level Gage

A combination liquid-level gage with adjustable low-limit switch will be used to provide visual indication of oil level and signal low-level conditions.

A.14.4.9 Indicating Level Switches

Indicating level switches shall be provided to signal a low-level condition. Water-level sensors shall be installed to signal a low water level condition. Sensors shall be either float or float-less, pressure sensitive, diaphragm actuated switches depending on the application.

A.14.4.10 Monitoring Instrumentation

Depending on a variety of causative factors, some structures will need to be monitored for water quality, which may or may not entail the use of autosamplers. In either case, flow measurement will be needed at select structures and in the case of structures with autosamplers, telemetry units capable of triggering the autosampler for flow-proportional sampling will be required. The installation of autosamplers and associated telemetry will also necessitate the need for routine support and access infrastructure including but not limited to stairs, platforms, housings, conduit, power supply, and stage gauges. The design and installation of all monitoring equipment and appurtenances will be coordinated with the SFWMD Water Quality Monitoring Section.

A.14.4.11 Station Emergency Power

Given a power outage, the flood control station requires emergency electric power backup. Typically, an adequately sized engine generator is provided for backup station service during the time that utility power is lost. In a large flood control station, a redundant system is provided. Controls are provided in the Automatic Transfer Switch (ATS) to either manually or automatically start the engine generator. At water control facilities (CU-1A, CU-1B, CU-2, DDS-1, and S-84+), an RTU output command will remotely stop the engine generator should the unit unnecessarily start.

A.14.4.12 Stage Monitors

Upstream and downstream stilling wells with water-level transmitters provide analog water-level data of the approach and discharge channels. A stilling well with a water-level transmitter is also provided in each pump intake to monitor low water levels. The water-level transmitters provide a proportional 4 to 20 mA

signal. The stilling well water-level transmitters are normally continuously powered from a 24 VDC power supply. Upon the loss of 120 VAC service, the RTU's "PULSE ANALOG CIRCUITS" program will intermittently power the 24 VDC power supply and scan the analog water-level transmitters.

A.14.5 Telemetry

The SCADA system RTU will be in the control building close to the antenna. The RTU will be a Motorola ACE unit to be compatible with the existing units already installed at other SFWMD locations. The pump station will be remotely monitored through the SFWMD's SCADA system. This is the SFWMD's proprietary system consisting of an RTU and an antenna. The RTU will be capable of transmitting data to a main station via radio. Data to be transmitted is to be determined. SFWMD requires the remote control of the station, which the SCADA system RTU of the station will provide this requirement.

A.15 Architectural

A.15.1 Design Criteria for Pump Station Buildings

A.15.1.1 Introduction

The pump station PS-1 building, pump station PS-2 building, and pump station SPS-1 building will be constructed to accommodate the pumps, motors, generators, and ancillary systems. In addition, adequate area will be provided for a control room, offices, break room, toilet room, locker/shower room, and mechanical equipment for the PS-1 and PS-2 buildings. Since SPS-1 will be located at the same site as PS-2, the SPS-1 building will not include offices, a break room, toilet room, or locker/shower room.

A.15.1.2 Design Requirements

A.15.1.2.1 Codes and Standards

Design and specifications of all work will be in accordance with the latest laws and regulations of the federal government, applicable state and local codes and ordinances, and applicable industry standards, including, but not limited to, the Florida Building Code (2020 edition) and the *SFWMDC Pump Station Engineering Guidelines* (January 2021 edition). Other recommended standards will be used where required to serve as guidelines for design, fabrication, and construction when not in conflict with the above standards. The pump station buildings will be designed in accordance with Florida Accessibility Code and ADAAG. Anti-terrorism/Force Protection measures for the building will be addressed during the 30 percent design phase. There is currently no requirement to achieve a Leadership in Energy and Environmental Design (LEED) construction certification for any of the pump station buildings.

A.15.1.2.2 Life Safety

The pump station buildings will be designed to meet the minimum construction and life safety requirements as required by the applicable codes and criteria. As described in **Section A.16**, appropriate type, size, and quantity of fire extinguishers will be provided in compliance with all applicable fire and life safety codes, including a sprinkler system in designated areas.

A.15.1.2.3 Material and Lifecycle

The pump station buildings will be designed to minimize lifecycle cost, energy consumption, and maintenance through proper selection of mass, form, materials, and construction standards. Integrally colored materials shall be used as much as possible to eliminate painting. The design life of the buildings will be a minimum of 50 years. Refer to **Sections A.10.3.5** and **A.10.3.6** for seismic and wind loading design criteria. The service life span will be the same as the building service life, except for the following: protective elements, wall primary weather-barrier elements, joint sealers, surfaces exposed to view, and roof covering weather barriers. These will have varying service lives, as shown in **Table A.15-1**.

Table A.15-1. Exceptions to the Building Service Lifespan.

Material	Lifecycle
Protective Elements	Minimum 20 years
Wall Primary Weather-barrier Elements	Minimum 50 years functional and aesthetic service life, excluding joint sealers
Joint Sealers (fuel resistant)	Minimum 20 years before replacement
Surfaces Exposed to View	Minimum 20 years aesthetic service life-No color fading, crazing, and delamination of applied coatings
Roof-covering Weather Barriers	Minimum 20 years, fully functional

A.15.2 Exterior Architectural Features for Pump Station Buildings

A.15.2.1 Shell

The elements forming usable enclosed space and separating that space from the external environment comprise the shell and consist of the following.

A.15.2.2 Superstructure

The superstructure includes all elements forming floors and roofs above grade and the elements required for their support, insulation, fireproofing, and fire stopping. The structural system for the superstructure shall be a steel or reinforced concrete frame with reinforced concrete walls and poured-in-place reinforced concrete roof and shall be designed in accordance with the applicable building codes as defined in **Section A.10.5**.

A.15.2.3 Exterior Enclosure

The exterior enclosure includes all essentially vertical elements forming the separation between exterior and interior conditioned space, including exterior skin, components supporting weather barriers, and jointing and interfacing components; this does not include the interior skin, unless it is an integral part of the enclosure. The exterior enclosure will be a reinforced concrete wall with required exterior paint/coating. Thermal performance for the exterior enclosure is not applicable to main equipment rooms. Exterior enclosures will be insulated for all air-conditioned spaces.

All exterior doors will be painted hollow metal doors with painted metal frames. Insulated doors will be used for secure air-conditioned spaces. Overhead doors will be roll-formed, galvanized steel construction, electrically operated, and will be sized to fit the largest equipment for the building. Louvers will be designed as required for ventilation of the spaces and equipment. The building wall openings for fans and louvers will have missile barrier protection over screens constructed to withstand 155 mph wind loading and windborne debris in accordance with the wind load design criteria specified in **Subsection A.10.3.6**. All doors and louvers will be hurricane-impact resistant.

A.15.2.4 Roofing

Roofing includes all elements forming weather and thermal barriers at horizontal roofs, decks, and roof fixtures. A single -ply roofing membrane will be used over the reinforced poured concrete roof deck. The roof will be sloped to stainless steel drain scuppers formed through the parapet. The roof runoff is directed down the walls via downspouts made from hollow structural tubing to resist missile impact

during hurricane events. All flashing, trim, and accessories will be of stainless steel sheet metal. Access to the roof will be provided by a roof hatch and will be controllable by authorized personnel only.

A.15.3 Interior Architectural Features for Pump Station Buildings

A.15.3.1 Floor

The minimum finished floor elevation (FFE) of the control room and main operating floor of all LOCAR pump station buildings as well as all control buildings for other LOCAR structures (including but not limited to CU-1B, CU-2 and DDS-1) will meet the requirements of the following standards/criteria:

- Latest edition of the Florida Building Code
- Flood Design Class 4 requirements in ASCE 24-14 Flood Resistant Design and Construction
- Federal Flood Risk Management Standard (FFRMS), as authorized under Federal Executive Orders 13990 and 14030
- Other minimum FFE standards/criteria determined during the PED phase of the Project.

See additional FFE requirements for the LOCAR pump stations in **Section A.12.2.3**.

Structures CU-1B, CU-2, and DDS-1 each include a control building with a proposed location on top of the perimeter/divider dam of the reservoir, as shown in the cross-section for each structure in **Annex C-1**. As shown in the wind and wave overwash modeling for the reservoir in **Section A.5**, these control buildings, under certain weather conditions, may experience dynamic loading from wave overwash. Therefore, during the PED phase of the Project, when the location and FFE elevation for each of these control buildings is being finalized, consideration must be given to the potential exposure to and magnitude of dynamic loading from wave overwash for each of these control buildings.

All floor slabs for all LOCAR buildings will be sealed, reinforced poured concrete.

A.15.3.2 Partitions

Partitions provided for physical separation between spaces will be constructed to achieve fire ratings required by code; appropriate security between adjacent spaces; and visual, acoustical, olfactory, and atmospheric isolation as necessary to maintain desirable conditions in each space. Partitions will comprise the following elements: Fixed partitions of fully-grouted, reinforced, full-height CMU; and partial height partitions of fixed, solid, opaque visual barriers for toilet compartments. The control room will have glass panels to allow the operator an unobstructed view of the operation floor. The control room/break room will be designed for sound proofing with a minimum sound transmission coefficient (STC) of 49.

A.15.3.3 Interior Doors and Windows

All interior doors shall be painted hollow metal doors with painted metal frames. Interior windows will be provided between adjacent spaces. Fixed interior windows and operable interior windows, when closed, will function as partition elements and will not degrade performance of partitions below the levels specified. Sound insulated doors and windows will be provided to meet the STC of not less than 49.

A.15.3.4 Interior Finishes

Offices/Control Room/Break Room

- Wall: Painted

- Floor: Non-skid ceramic tiles
- Ceiling: Suspended acoustical ceiling tiles

Toilets/Showers

- Wall: Ceramic tiles
- Floor: Non-skid ceramic tiles
- Ceiling: Moisture resistant gypsum board

Locker Room

- Wall: Painted
- Floor: Non-skid ceramic tiles
- Ceiling: Moisture-resistant gypsum board

Equipment Room/Maintenance Shop/Janitor's Closet

- Wall: Painted
- Floor: Sealed concrete
- Ceiling: None. All exposed concrete will be painted

Fan/Filter Rooms

- Wall: Painted
- Floor: Sealed concrete
- Ceiling: None. All exposed concrete will be painted

A.15.3.5 Vertical Circulation

Stairs will be provided for access to mechanical spaces and equipment mezzanines. Also, a vertical lift that meets accessibility requirements will provide access to the control room.

A.15.3.6 Interior Fixtures

Interior fixtures permanently attached to interior walls, ceilings, and floors, except for equipment items, will be provided and comprise the following elements:

A.15.3.6.1 Identifying Devices

Informational accessories, including room numbers, signage, and directories.

A.15.3.6.2 Storage Fixtures

Items intended primarily for storing or securing objects, materials, and supplies, including cabinets, casework, and shelving.

A.15.3.6.3 Accessory Fixtures

Specialty items intended to provide service or amenity to building interiors, including toilet and bath accessories, visual display surfaces, and telecommunications fixtures.

A.15.3.6.4 Other Interior Fixtures

Other items fixed to the interior construction that enhance comfort or amenity in building spaces.

A.16 HVAC, Plumbing, and Fire Suppression Systems

A.16.1 Design Criteria for Pump Station Buildings

The following describes the basis of mechanical design and criteria associated with the HVAC, plumbing, and fire suppression systems for the pump station PS-1 building, pump station PS-2 building, and pump station SPS-1 building. **Table A.16-1** details the Project site design criteria; **Table A.16-2** details the indoor design criteria for the Project.

Table A.16-1. Project Site Design Criteria.

	PS-1	PS-2 and SPS-1
Site Elevation		
Above sea level, feet North American Vertical Datum of 1988	34	27
Site Location		
North latitude, degrees	27	27
West longitude, degrees	81	81
Ambient Design Temperatures¹		
Winter, design dry bulb, degrees Fahrenheit (°F)	36.4	36.4
Summer, design dry bulb/mean coincident wet bulb, °F	93.4	93.4
Dehumidification, design dew point, °F	81	81
Degree Days		
Heating (Base 65°F), days	456	456
Cooling (Base 50°F), days	8348	8348
Rainfall Intensity²		
Actual, inches/hour	5	5
Design, inches/hour	5	5

¹The winter and summer design temperatures are based on the American Society of Heating, Refrigerating, and Air-conditioning Engineers frequency levels of 99.6 percent and 1 percent, respectively.

²The actual rainfall intensity rate is based on a 60-minute duration and 100-year return period.

A.16.2 HVAC for Pump Station Buildings

The following is a description of the HVAC systems.

A.16.2.1 Heating Systems

Heating will be provided via heat pump DX system serving the toilet/locker/shower and control rooms in the PS-1 and PS-2 buildings. Since SPS-1 will be located at the same site as PS-2, the SPS-1 building will not include any toilet, locker, or shower rooms.

Table A.16-2. Indoor Design Criteria for PS-1 Building and PS-2 Building.

Area	Design Temperatures (°F) ¹			Minimum Ventilation Requirements	Ventilation Notes
	Summer	Winter			
	Design	Design	Setpoint		
Generator Room	104	50	50	1.5 cfm/sf (C)	Note 2
Operating Floor	78	72	72	--	Note 1,4
Janitor's Closet	104	--	--	0.5 cfm/sf (I)	Note 1,2
Control Room	70	70	70	--	Note 1,4
Break Room	78	72	72	--	Note 1,4
Locker Room	78	72	72	--	Note 1,3
Restroom(s)	78	72	72	--	Note 1,3

^{°F}–degrees Fahrenheit

AC/HR designates air changes per hour

cfm/sf–cubic feet per minute per square foot

(C) designates the ventilation system operates continuously

(I) designates the ventilation system operates intermittent

¹ Indoor conditions reflect operating temperatures for personnel comfort, code/standard recommendations, or equipment protection.

Notes:

1. The ventilation system will be sized on the more restrictive of the AC/HR (or cfm/sf) listed, or the airflow required to maintain the indoor design temperature based on the summer outside design temperature.
2. Additional intermittent ventilation will be provided as required to maintain the indoor design temperature based on the summer outside design temperature, or to meet the engine combustion air requirements.
3. The exhaust rate will be based on the most stringent requirement of: 0.5 cfm/sf of floor area or 70 cfm per toilet or urinal.
4. The ventilation rate will be based on ASHRAE 62.1-2019.

A.16.2.2 Ventilation Systems

A forced air ventilation system will be provided for the operating floor area of the PS-1, PS-2, and SPS-1 buildings. The system will utilize wall propeller fans for supply and wall propeller fans for exhaust. The supply air system will consist of louvers for air intake, automatic roll filters for filtering, and wall propeller fans for supply and exhaust. The wall fans will be mounted internally to provide protection from elements.

In addition, for the PS-1, PS-2, and SPS-1 buildings, roll filters and supply fans will be located in the generator room along the wall opposite from the generator engine. The exhaust fans will be located high above the floor on the engine side of the generator room. The ventilation system will remove the heat gains from the equipment as well as supply make up air for the generator engine air intake.

The intake and exhaust louvers will be Miami-Dade County approved, and will be provided with missile barriers.

The ventilation system fans will be controlled by their individual “ON-OFF-AUTO” selectors switches. When the exhaust fan selector switches are in the “AUTO” position, the exhaust fans will be interlocked with the controls for the supply fans. When the supply fan selector switches are in the “AUTO” position, the quantity of supply fans operated will be automatically controlled based upon the quantity of engines operating in the engine pump room and controlled by the room thermostats in the engine pump room.

A.16.2.3 Air Conditioning Systems

For the PS-1 and PS-2 buildings, the air conditioning systems will be split system type heat pumps. A heat pump will be provided for the shop, control room, break room, locker room, and restroom. The heat pump serving the break room, locker room, and restroom will also be ducted to provide a backup to the control room's air conditioning system. Each heat pump will be provided with a backup emergency electric heating coil. Each unit will be controlled by a remote wall-mounted thermostat to maintain the desired space temperature. The air handling units and heat pumps will be located inside the pump station. The locker room, restroom, and janitor's closet will be exhausted by duct fans ducted to exhaust louver or wall caps.

A.16.3 Potable Water for Pump Station Buildings

Investigation of potable water usage at existing major pumping stations G-310 and G-370 indicates low demand and infrequent use of potable water. Potable water is supplied to a kitchen sink, restrooms, and showers. Bottled water is used for drinking. It was reported that the current potable water systems are sized for more demand than the system experiences and, as a result, the treatment systems are experiencing problems due to a lack of flow.

As an alternative to the potable water supply system installed at the existing pumping stations, which is canal water processed through sand filters and reverse osmosis (RO) membranes, the use of a shallow water well will be considered. Treatment of this water could be with aeration, canister filtration, chlorination, and softening.

The design for the PS-1 and PS-2 buildings will incorporate storage that will serve the typical low demand, but also accommodate the infrequent periods of larger demands when the pump station houses personnel during extreme weather events. Changing the potable water source to a well would require water quality sampling and analyzing and, based on the results of the analysis, an appropriate water purification system would be compared to the current RO treatment system. Alternative systems will be considered during the engineering design phase of the Project.

The potable water system selected shall supply potable water to restrooms, sinks, and showers at the PS-1 and PS-2 buildings. An electric-powered domestic water heater will be provided to supply water at 120 degrees Fahrenheit to the sinks and showers.

A.16.4 Freshwater Supply System for Pump Station Buildings

A freshwater system will be provided at the PS-1, PS-2, and SPS-1 buildings to supply water to hose bibs for washdown areas, as well as supply lubricating/cooling water for pump bearings and bearing seals. The freshwater system will be supplied by water from the adjacent canal and treated using in-line strainers.

A.16.5 Sanitary System for Pump Station Buildings

For the PS-1 and PS-2 buildings, all plumbing fixtures that require drainage will discharge to the sanitary system. In addition, floor drains located in the locker room and restrooms will discharge to the sanitary system. Floor drains will not be provided in the pump room so that potential oily waste will not be discharged to the sanitary system. Sanitary drainage from the building will be collected in a septic tank. Soil tests will be conducted to verify the efficiency of a septic drain (leach) field. If the soil conditions are

not favorable for a drain field, or the amount of discharge is determined to be minimal, the septic tank could be used for storage of wastewater and pumped regularly for removal off-site.

A.16.6 Stormwater System for Pump Station Buildings

Storm drainage will be collected from the roof drains and leaders. All storm drainage at each pump station will be routed to the forebays.

A.16.7 Fire Suppression System for Pump Station Buildings

It is expected that an automatic fire sprinkler and detection system will be required for each pump station facility. Further code investigation will confirm this requirement during detailed design. If a sprinkler system is required, a pre-action system will be provided. The sprinkler system and portable fire extinguishers will be installed in accordance with NFPA 13 standards.

The SFWMD will review all design assumptions, criteria, and calculations. Verification with the SFWMD and the SFWMD's insurance underwriter shall be done for the fire protection systems.

A.17 Access and Security

A.17.1 Access

SFWMD staff and the public will be able to access the reservoir from the C-41A north levee road that connects to the northwest side of SR 70 near the SR 70 bridge, which crosses over C-41A. Public access to the reservoir site will be for recreational opportunities, as discussed in **Appendix F**. Public access to the crest road along the top of the reservoir dam perimeter and divider dam will be provided at various locations along the perimeter of the reservoir, as described in **Appendix F**. Access ramps and pullout areas (for turnaround and passing maneuvers) will be provided along the reservoir perimeter dam at the required intervals per DCM-4.

A.17.2 Security

The reservoir and its associated project features will follow the security guidelines of the SFWMD and the U.S. Department of Homeland Security. During the PED phase, the final design of all security features and elements will be coordinated with and approved by the SFWMD field station staff and security staff.

A.17.2.1 Fences and Gates

The reservoir site is within an agricultural area. The agricultural land adjacent to the reservoir site is used as cattle pasture and for cultivation of citrus crops, sugarcane, and other crops. For access control and to prevent cattle from wandering onto the reservoir site, a five-strand, barbed wire fence, in accordance with Natural Resources Conservation Service Florida Code 382 barbed wire fence standards for cattle and horses, will be installed along the entire perimeter of the reservoir site. Access gates located along the perimeter barbed wire fence will be prefabricated, galvanized steel, livestock swing gates composed of 16-gauge (or heavier), 2-inch-diameter (or larger) steel tubing, with at least six horizontal rails. Each access gate will be provided with a lock that is keyed to match the SFWMD's current lock system.

The Project pump stations PS-1, PS-2, and SPS-1, Spillway S-84+, and other gated water control structures will have controlled access through the use of fences and gates. Each access gate will be provided with a lock that is keyed to match the SFWMD's current lock system. Electric gates and locks are not anticipated.

A.17.2.2 Site Monitoring at Pump Stations PS-1, PS-2, and SPS-1, and Spillway S-84+

A closed-circuit television system will be employed for security at pump stations PS-1, PS-2, and SPS-1 and at spillway S-84+. Cameras will be located at each entrance for the control buildings associated with PS-1, PS-2, SPS-1, and S-84+, as well as strategically located within each control building. Cameras will also provide views of vehicle entrance gates.

A.17.2.3 Building Access at Pump Stations PS-1, PS-2, and SPS-1, and Spillway S-84+

Items that will be considered when controlling access to the control buildings associated with PS-1, PS-2, SPS-1, and S-84+ will include:

- Door position switches;
- Interior motion sensors; and
- Keypad access with timed alarm override.

A.18 Operations and Maintenance

Operation, maintenance, repair, replacement, and rehabilitation (OMRR&R) begins after Project construction and operational testing and monitoring are complete; and generally, includes all operation activities and maintenance needed to keep the Project features functioning as intended. OMRR&R for the Project will occur for all new facilities constructed as a part of the Project. The Draft Project Operations Manual is included in **Annex C**. The OMRR&R costs are included in the main report and in **Appendix B**.

OMRR&R will include, but not be limited to, the following maintenance activities:

- Pump and facility maintenance will be in accordance with the manufacturers' recommendations and schedules.
- The repair and rehabilitation of pumps, drivers, and switchgear are assumed to be rehabilitated or replaced once during their 50-year service life.
- Erosion control will ensure that the stability of banks and areas around culverts and other structures are not compromised by weather, plants, or animals.
- Mowing will occur to maintain grass areas for a neat and clean appearance and to ensure no other maintenance issues are being hidden by high grass or other vegetation. Mowing also reduces the ability of woody plants to gain a foothold, which can lead to other maintenance issues.
- Invasive, exotic, native, and nuisance vegetation control will be applied. Vegetation control is done both to control underwater infestations and surface infestations. Invasive plants have the capacity to impair the function of various Project components and can damage vital structural components if allowed to grow unchecked.
- Culvert maintenance will be conducted, including inspection, regular maintenance of mechanical and electrical equipment for slide gates, and debris removal.
- Weir maintenance will be conducted, including concrete and corrosion repair.
- Canal maintenance will be conducted, including channel elevation and debris removal.

The locations of boat ramps, access ramps, and gates for O&M purposes of the Project will be determined during the PED phase of the Project.

A.19 Dam Safety Considerations and Emergency Action Plan

A.19.1 Dam Safety Considerations

LOCAR will typically impound water for months at a time during annual wet and dry seasons. LOCAR is considered a dam according to criteria in Corps Engineering Regulation (ER) 1110-2-1156 Dam Safety Policies and Procedures. As stated in **Section A.5.1**, the dam will be considered a high-hazard facility according to ER 1110-2-1156, the Federal Emergency Management Agency's (FEMA) Selecting and Accommodating Inflow Design Floods for Dams, and Design Criteria Memorandum 1 (DCM-1), Hazard Potential Classification, due to the potential for life loss if the facility were to fail.

To evaluate the extent of flooding from a potential breach in the dam, a two-dimensional hydrodynamic dam breach model of the Recommended Plan (presented in the LOCAR Section 203 Feasibility Study Report, dated October 2023) was developed using Corps Hydrologic Engineering Center's River Analysis System (HEC-RAS) v6.3.1. Four breach locations were evaluated to focus on the biggest impacts to transportation, residential, and agricultural lands near the reservoir. The four breach locations evaluated were:

1. Location 1: From LOCAR towards the Kissimmee River to the residential properties and County Road 721
2. Location 2: From LOCAR towards C-41A, residential properties, and State Road 70
3. Location 3: From LOCAR away from C-41A towards State Road 70 and C-40
4. Location 4: From LOCAR away from C-41A towards the Brighton Valley Impoundment

For each breach location, three dam breach conditions were evaluated: Sunny Day; 100-year, 72-hour rain event; and Probable Maximum Precipitation (PMP). Two non-breach conditions were also evaluated, one for the 100-year, 72-hour rain event and the other for the PMP. For each of the breach conditions evaluated, the reservoir was modeled as a single-cell reservoir without the proposed divider dam that forms the reservoir's two storage cells. During the PED phase of the Project, additional conditions will be evaluated, including but not limited to:

- Breach conditions where the reservoir is modeled as a two-cell reservoir with its proposed divider dam.
- Condition where there is no reservoir included in the model, evaluated for the 100-year, 72-hour rain event and PMP. The results from these two simulations will be compared to the results from the simulation for the 100-year, 72-hour rain event and the simulation of the PMP, where the reservoir is included in the model, and no breach in the reservoir's dams occur. The comparison of these simulations will be used to evaluate the potential impact of discharges from the reservoir's gated and non-gated spillways during these two storm events, on the C-41A basin.

These additional dam breach conditions to be evaluated during the PED phase, will inform aspects of the emergency action plan (EAP) for the Project, to be developed during the PED phase as described in **Section A.19.2**.

Dam breach modeling performed for the LOCAR Section 203 Study in accordance with DCM-1, indicates that State Road 70 and the farmland surrounding the Project site will likely be significantly impacted in the event of a breach of the reservoir's perimeter dam. A breach could lead to life threatening conditions

for nearby farm personnel and motorists along State Road 70 and impede emergency evacuation routes along State Road 70 and other roads within Highlands and Glades Counties. During the PED phase of the Project, when the consequences modeling is updated based on the updated dam breach modeling completed during PED, the consequences modeling should include simulated traffic along State Road 70, based on the latest traffic data from FDOT for State Road 70.

Figure A.19-1 shows the extent of flooding that was simulated by the LOCAR dam breach model for the sunny day dam breach at Location 4. Note, **Figures A.19-1 through A.19-5** are from the dam breach modeling technical memorandum in **Annex A-2.7**. The term Alternative 1 in **Figures A.19-1 through A.19-5** refers to the Recommended Plan presented in the LOCAR Section 203 Feasibility Study Report, dated October 2023. The flood extent from the breach in this simulation shows flooding within the Brighton Valley Impoundment with a portion of flooding extending south of State Road 70. Maximum flood depths from the Sunny Day breach at Location 4 are estimated to reach portions of the Brighton Valley Impoundment within 0 to 2 days, and most of the area immediately north of State Road 70 and south of State Road 70 but north of C-41A in 0.6 to 1 day. The residential communities along State Road 70 and the community immediately south of Lake Istokpoga are estimated to have maximum flood depths in 1.1 to 1.5 days.

Figure A.19-2 shows the extent of flooding that was simulated for a 100-year, 72-hour rain event; and **Figure A.19-3** shows only the portion of additional flooding caused by a dam breach at Location 4 during a 100-year, 72-hour rain event. The model simulation shows an increase in flood depths by 0 to 0.5 feet concentrated along the Kissimmee River, to the south and west of Brighton Valley Impoundment, a portion of Brighton Indian Reservation, and areas between L-61/L-60 and HHD. The “hammock” area to the south of reservoir will experience more than 2 feet of increased depth due to a breach. The breach flood wave will increase the flood depths by more than 2 feet in the Brighton Valley Impoundment and to the south of State Road 70. The increase in depths along HHD, Kissimmee River, and C-40 and C-41 could be caused by a slight change in flood arrival times of peak discharges caused by the breach flood wave.

Figure A.19-4 shows the extent of flooding that was simulated for a PMP event; and **Figure A.19-5** shows only the portion of additional flooding caused by a dam breach at Location 4 during a PMP storm. The simulation shows that most of the model domain along C-41, C-40, and the area between L-61 and HHD has an increase in flood depths by less than 0.5 feet caused by the PMP breach at Location 4. The portion of the model domain in Glades County, between L-60 and HHD, with an increase in flood depths by 0.6 to 1 foot, could be caused by overtopping of portion of C-40 and C-38 and a slight change in flood arrival times of peak discharges caused by the breach flood wave. The maximum increase in flood depths is observed immediately to the south of the reservoir in the “hammock” area and inside Brighton Valley Impoundment with an increase in flood depths more than 2 feet.

Additional details about the dam breach modeling and results for the other breach locations/simulations are included in the dam breach modeling technical memorandum in **Annex A-2.7**.

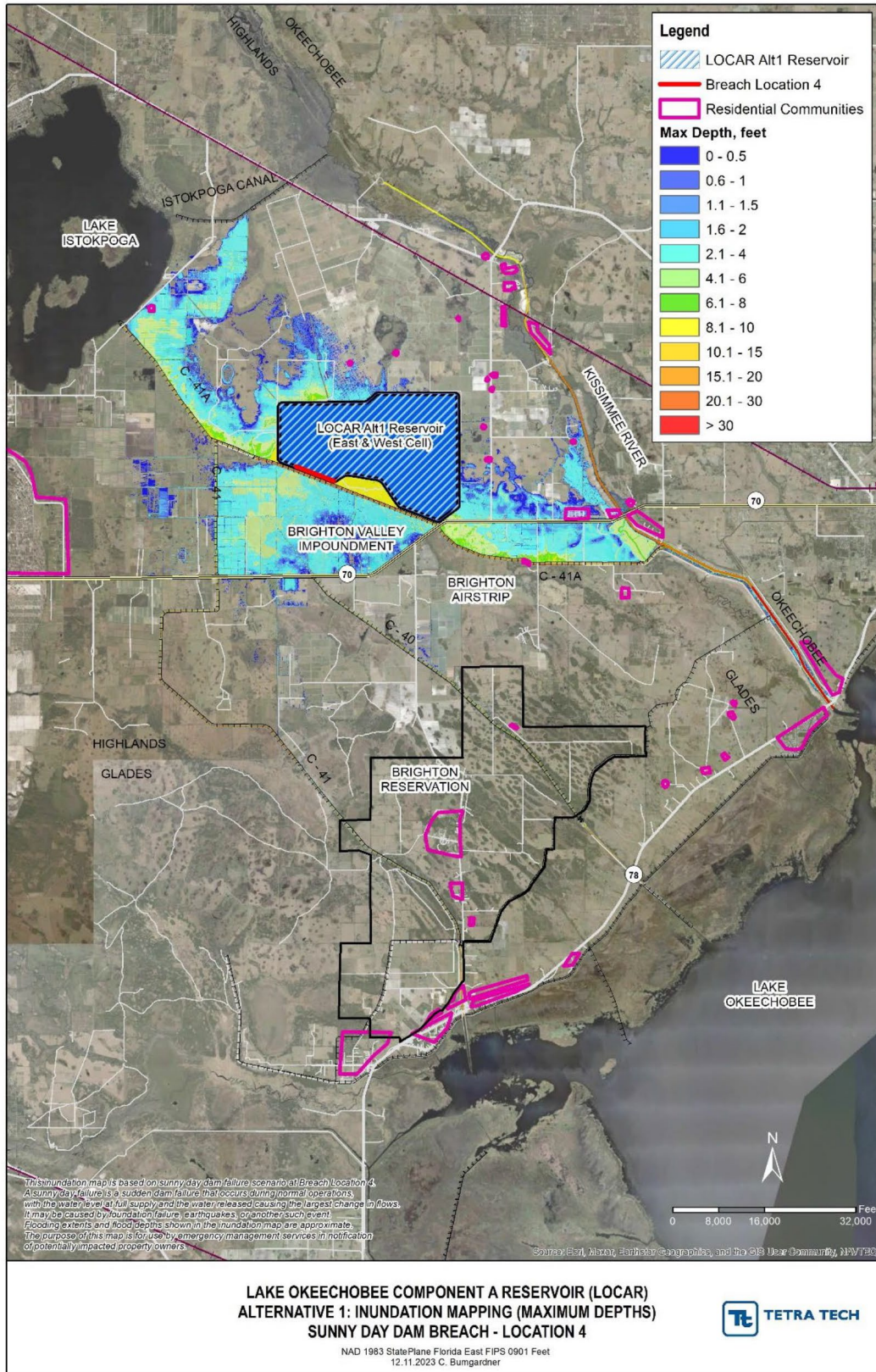

Figure A.19-1. Sunny Day Flooding Extent from a Breach at Location 4.

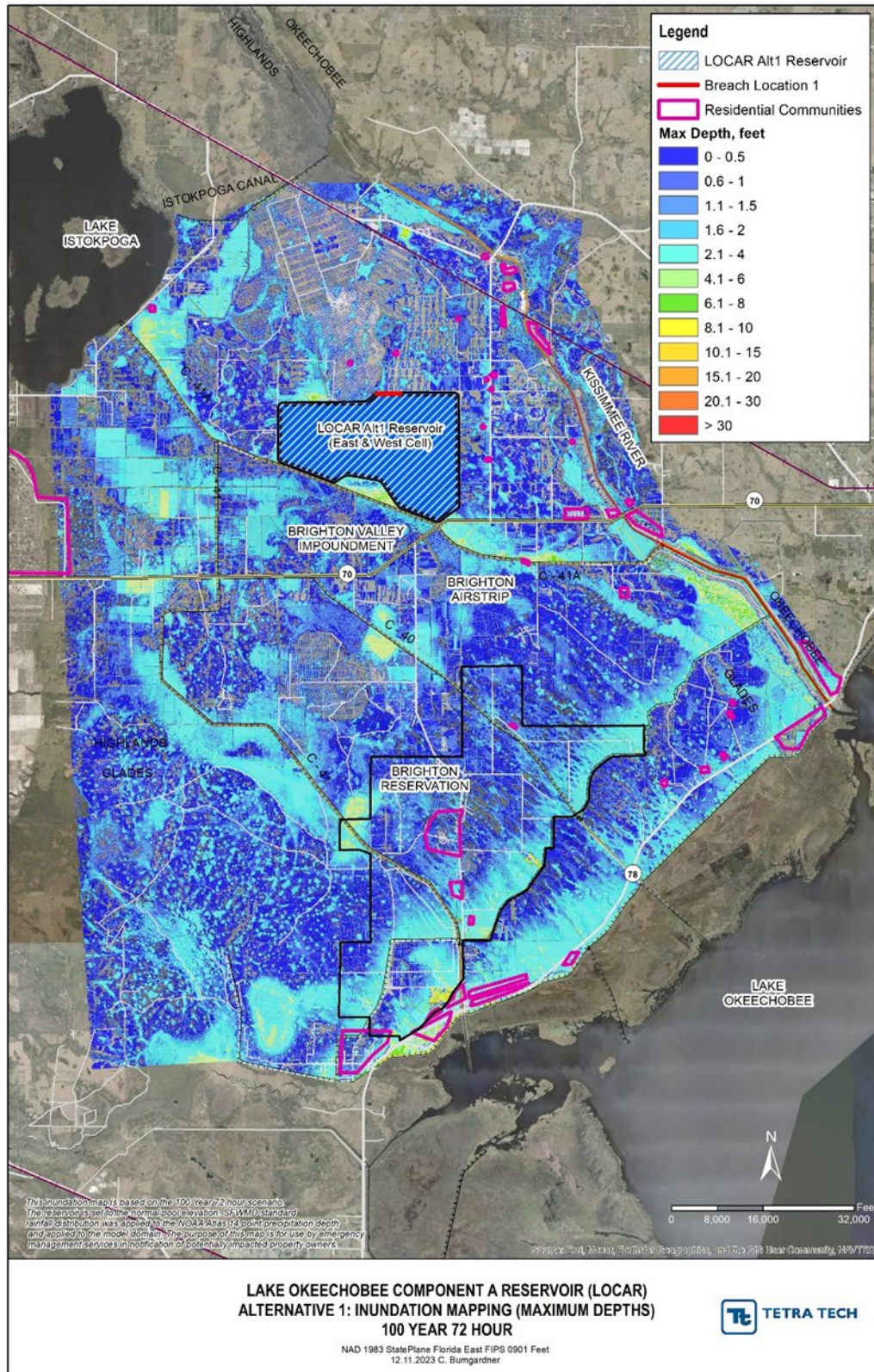

Figure A.19-2. Maximum Depths from a 100-year, 72-hour Rain Event.

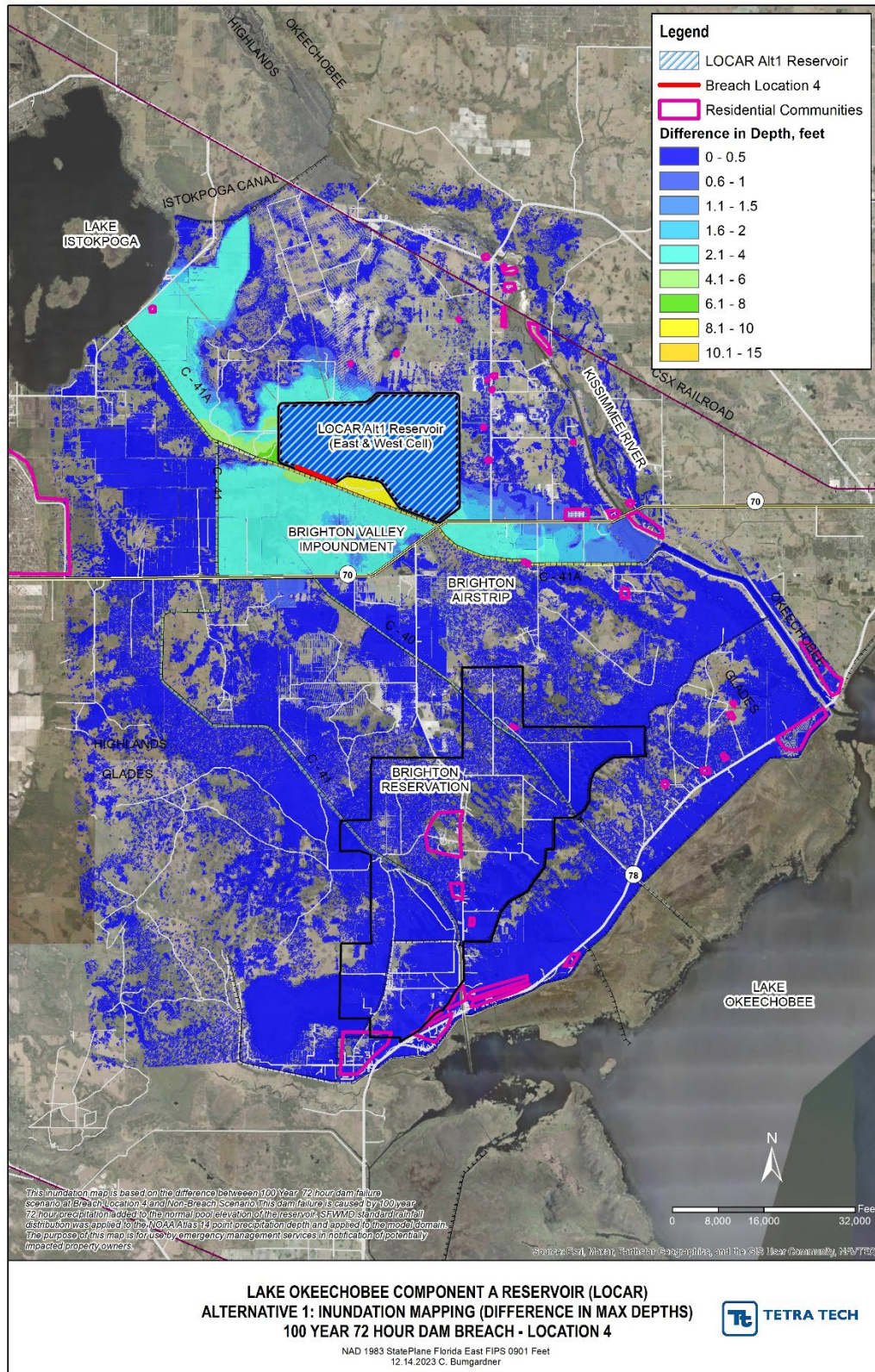

Figure A.19-3. Difference in Maximum Depths from a 100-year, 72-hour Breach and Non-Breach Conditions at Location 4.

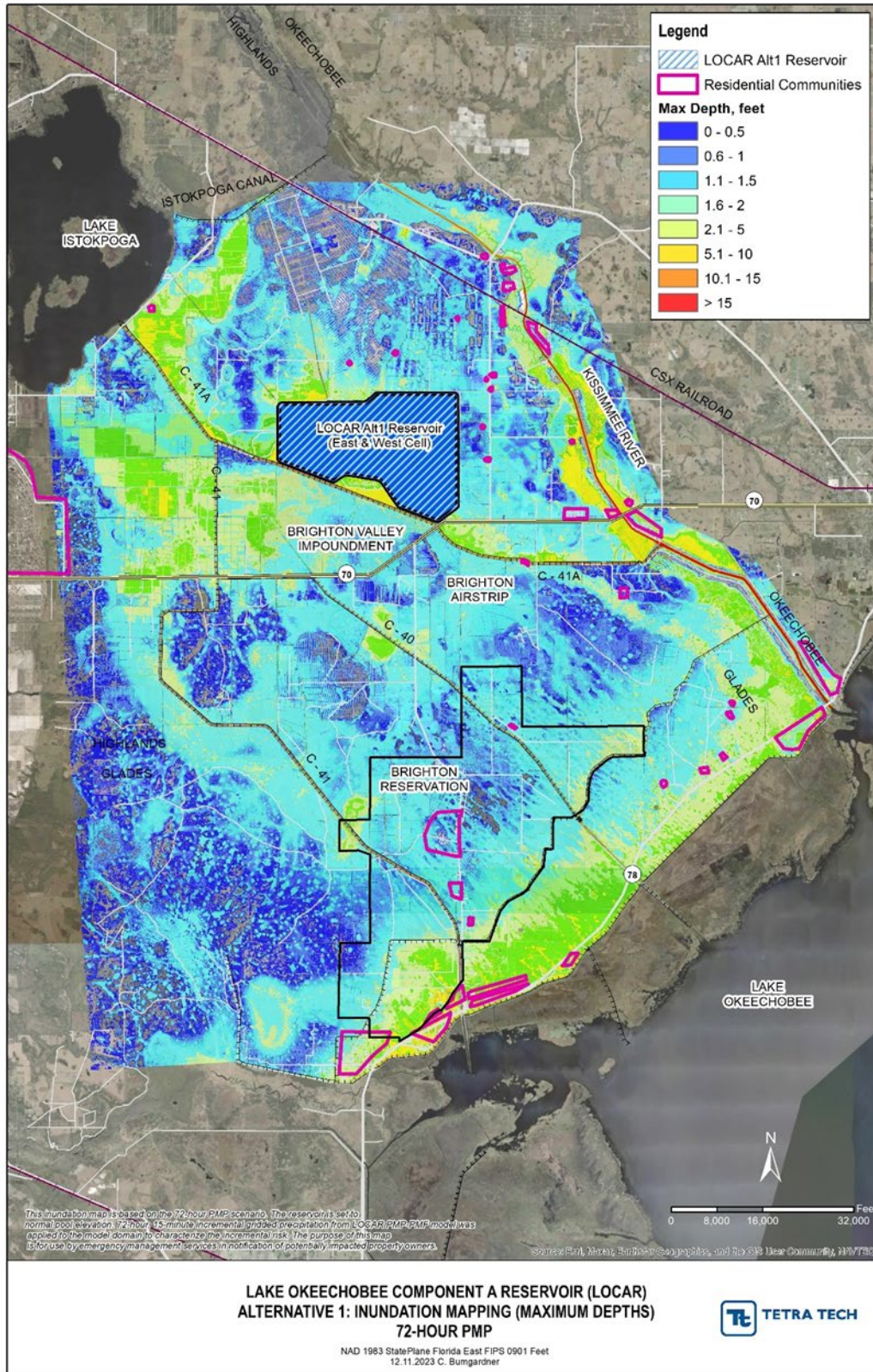

Figure A.19-4. Maximum Depths from a PMP Storm.

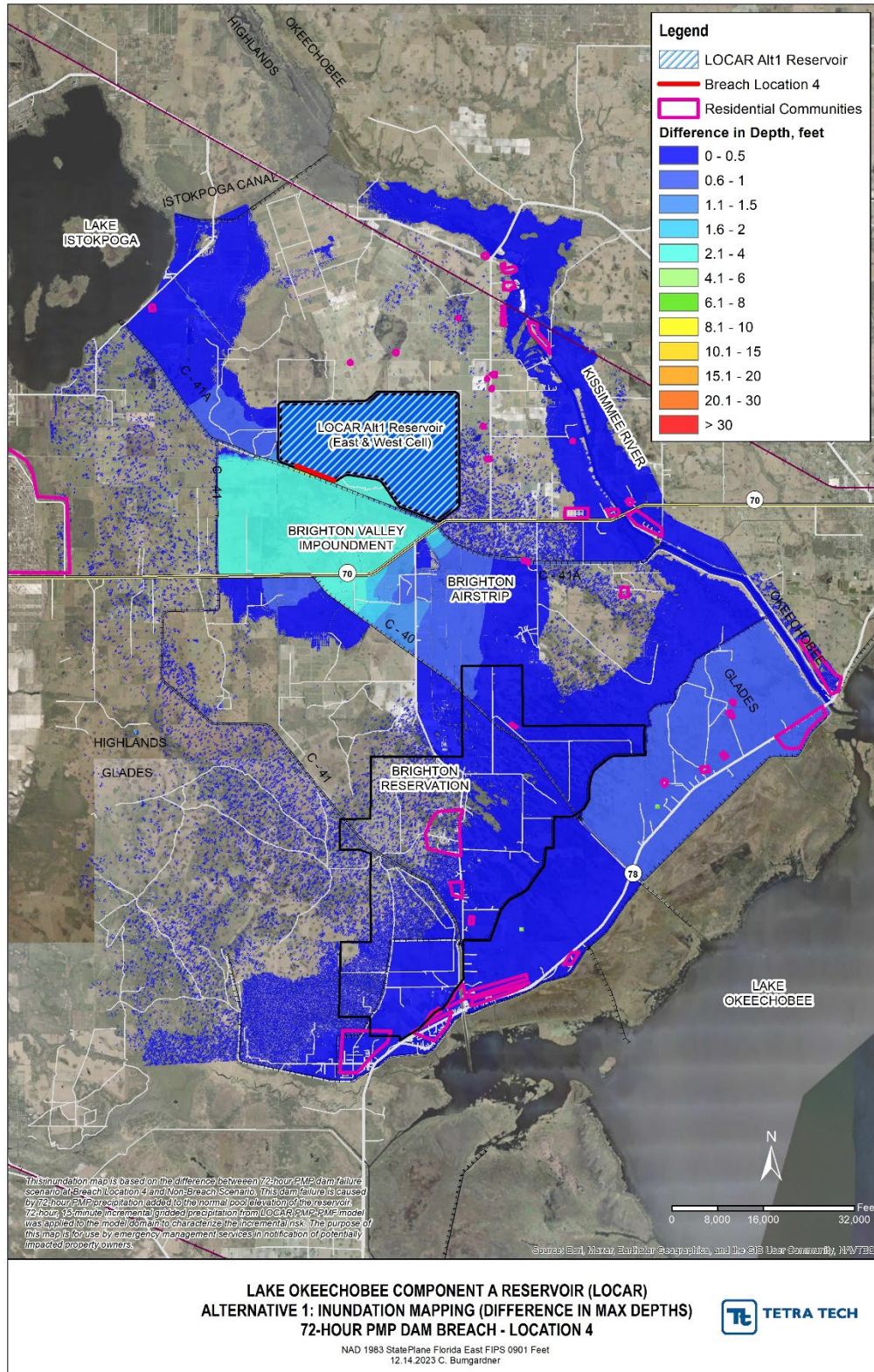

Figure A.19-5. Difference in Maximum Depths from a PMP Breach and Non-Breach Conditions at Location 4.

A.19.2 Emergency Action Plan

An EAP is commonly defined as a plan developed by a property owner that establishes procedures for notification to state and federal agencies, public off-site authorities, and other agencies of emergency actions to be taken in an impending or actual failure of an impoundment with a high hazard potential classification. Agencies with EAP guidance includes FEMA (e.g., FEMA's Dam Safety Federal Guidelines, including FEMA P-64 and FEMA P-946), Federal Energy Regulatory Commission (FERC), U.S. Bureau of Reclamation (USBR), State Dam Safety Offices, as well as local community/county representatives. Impoundments classified as high hazard potential, typically require the most stringent and detailed EAPs.

As discussed in **Section A.5.1** and **Section A.19.1**, the reservoir, as designed according to the Recommended Plan, is classified as a high hazard potential impoundment. The reservoir will need a comprehensive EAP, prepared during the PED phase, that reflects its classification as a high hazard potential impoundment. The EAP would need to be completed and approved by the appropriate governmental agencies before the first filling of the reservoir. The EAP would need to be developed in conjunction with updates to the reservoir dam breach modeling performed during the PED phase of the Project. The EAP should acknowledge that one of the highest potential areas for life loss in the event of a reservoir dam breach is State Road 70. The EAP should include procedures for closure of State Road 70 in the event that a breach is imminent or has occurred.